

APPENDIX E



October 29, 2018

Leslie Coburn
Environmental Review Coordinator
State Historic Preservation Office
50 Sherburne Ave
Admin Bldg #203
St. Paul, MN 55155

**Re: Notice of Proposed Detroit Lakes 115 kV Transmission Line Project
Detroit Lakes, MN
Detroit Lakes Public Utilities**

Dear Ms. Coburn,

Detroit Lakes Public Utilities (DLPU) has retained DGR Engineering to assist with the permitting process on a new project to construct 2.19 miles of 115 kV transmission line in Sections 21, 28, and 33, T138N, R41W in Becker County, MN. The proposed transmission line will source a new substation located in Section 21, T138N, R41W, Becker County, MN. The proposed project is needed to provide additional capacity to the projected loads in the southern portion of the DLPU service territory. Enclosed is a map, Figure 1, showing the proposed transmission line route and substation location.

The purpose of this letter is to provide Notice of DLPU's plan to obtain a route permit from the Minnesota Public Utilities Commission (MPUC) and to request any comments that you have on the proposed project.

Project Description

The south terminus will be the existing 115 kV transmission line location in Section 33, T138N, R41W. The proposed transmission line will head north approximately 0.07 mile and cross US Highway 59. The transmission line will continue north in public right-of-way of US Highway 59 for approximately 2.12 miles. The north terminus of the proposed transmission line will be the said proposed DLPU substation. The total distance of this line will be approximately 2.19 miles.

The proposed project includes installation of overhead transmission conductors on a single, steel pole with span lengths of approximately 300'. Enclosed is a drawing, Figure 2, which shows the typical construction assembly that will be utilized.

Permitting Requirements

The proposed 115 kV transmission line meets the definition under Minn. Rules Chapter 7850.1000, subp. 9 of a High Voltage Transmission Line (HVTL). A route permit is required for the project, for which DLPU will apply.

A Certificate of Need (CON) is not required for this project because it does not classify as a large energy facility under Minn. Stat. §§216B.243 and 216B.2421, subd. 2(3). While the project is a HVTL with capacity of 100kV or more, it is not more than 10 miles long and does not cross a state line. Therefore, DLPU does not need a CON for this project.

The route permit proceeding will determine the final location of proposed facilities. As part of the permitting process, the MPUC considers input from the applicant utility, interested stakeholders, local government units, state and federal agencies, and land owners who may be affected. DLPU plans to submit an application for a route permit for the project to the MPUC within one month. The routing process will consider potential environmental, land use, and other impacts, and provide an opportunity for the public to comment.

If additional information is desired regarding this proposed project, please contact me by email at dennis.haselhoff@dgr.com or by phone at (712) 472-2531. I look forward to hearing from you.

Sincerely,

A handwritten signature in blue ink, appearing to read "Dennis Haselhoff".

Dennis Haselhoff, P.E.
Project Engineer

Enclosures: Figure1, Figure 2



October 29, 2018

Peter Mead
Administrator
Becker Soil & Water Conservation District
809 8th St SE
Detroit Lakes, MN 56501

**Re: Notice of Proposed Detroit Lakes 115 kV Transmission Line Project
Detroit Lakes, MN
Detroit Lakes Public Utilities**

Dear Mr. Mead,

Detroit Lakes Public Utilities (DLPU) has retained DGR Engineering to assist with the permitting process on a new project to construct 2.19 miles of 115 kV transmission line in Sections 21, 28, and 33, T138N, R41W in Becker County, MN. The proposed transmission line will source a new substation located in Section 21, T138N, R41W, Becker County, MN. The proposed project is needed to provide additional capacity to the projected loads in the southern portion of the DLPU service territory. Enclosed is a map, Figure 1, showing the proposed transmission line route and substation location.

The purpose of this letter is to provide Notice of DLPU's plan to obtain a route permit from the Minnesota Public Utilities Commission (MPUC) and to request any comments that you have on the proposed project.

Project Description

The south terminus will be the existing 115 kV transmission line location in Section 33, T138N, R41W. The proposed transmission line will head north approximately 0.07 mile and cross US Highway 59. The transmission line will continue north in public right-of-way of US Highway 59 for approximately 2.12 miles. The north terminus of the proposed transmission line will be the said proposed DLPU substation. The total distance of this line will be approximately 2.19 miles.

The proposed project includes installation of overhead transmission conductors on a single, steel pole with span lengths of approximately 300'. Enclosed is a drawing, Figure 2, which shows the typical construction assembly that will be utilized.

Permitting Requirements

The proposed 115 kV transmission line meets the definition under Minn. Rules Chapter 7850.1000, subp. 9 of a High Voltage Transmission Line (HVTL). A route permit is required for the project, for which DLPU will apply.

A Certificate of Need (CON) is not required for this project because it does not classify as a large energy facility under Minn. Stat. §§216B.243 and 216B.2421, subd. 2(3). While the project is a HVTL with capacity of 100kV or more, it is not more than 10 miles long and does not cross a state line. Therefore, DLPU does not need a CON for this project.

The route permit proceeding will determine the final location of proposed facilities. As part of the permitting process, the MPUC considers input from the applicant utility, interested stakeholders, local government units, state and federal agencies, and land owners who may be affected. DLPU plans to submit an application for a route permit for the project to the MPUC within one month. The routing process will consider potential environmental, land use, and other impacts, and provide an opportunity for the public to comment.

If additional information is desired regarding this proposed project, please contact me by email at dennis.haselhoff@dgr.com or by phone at (712) 472-2531. I look forward to hearing from you.

Sincerely,

A handwritten signature in blue ink, appearing to read "Dennis Haselhoff".

Dennis Haselhoff, P.E.
Project Engineer

Enclosures: Figure1, Figure 2



October 29, 2018

Edward Musielewicz
District Conservationist
NRCS
809 8th St SE
Detroit Lakes, MN 56501

**Re: Notice of Proposed Detroit Lakes 115 kV Transmission Line Project
Detroit Lakes, MN
Detroit Lakes Public Utilities**

Dear Mr. Musielewicz,

Detroit Lakes Public Utilities (DLPU) has retained DGR Engineering to assist with the permitting process on a new project to construct 2.19 miles of 115 kV transmission line in Sections 21, 28, and 33, T138N, R41W in Becker County, MN. The proposed transmission line will source a new substation located in Section 21, T138N, R41W, Becker County, MN. The proposed project is needed to provide additional capacity to the projected loads in the southern portion of the DLPU service territory. Enclosed is a map, Figure 1, showing the proposed transmission line route and substation location.

The purpose of this letter is to provide Notice of DLPU's plan to obtain a route permit from the Minnesota Public Utilities Commission (MPUC) and to request any comments that you have on the proposed project.

Project Description

The south terminus will be the existing 115 kV transmission line location in Section 33, T138N, R41W. The proposed transmission line will head north approximately 0.07 mile and cross US Highway 59. The transmission line will continue north in public right-of-way of US Highway 59 for approximately 2.12 miles. The north terminus of the proposed transmission line will be the said proposed DLPU substation. The total distance of this line will be approximately 2.19 miles.

The proposed project includes installation of overhead transmission conductors on a single, steel pole with span lengths of approximately 300'. Enclosed is a drawing, Figure 2, which shows the typical construction assembly that will be utilized.

Permitting Requirements

The proposed 115 kV transmission line meets the definition under Minn. Rules Chapter 7850.1000, subp. 9 of a High Voltage Transmission Line (HVTL). A route permit is required for the project, for which DLPU will apply.

A Certificate of Need (CON) is not required for this project because it does not classify as a large energy facility under Minn. Stat. §§216B.243 and 216B.2421, subd. 2(3). While the project is a HVTL with capacity of 100kV or more, it is not more than 10 miles long and does not cross a state line. Therefore, DLPU does not need a CON for this project.

The route permit proceeding will determine the final location of proposed facilities. As part of the permitting process, the MPUC considers input from the applicant utility, interested stakeholders, local government units, state and federal agencies, and land owners who may be affected. DLPU plans to submit an application for a route permit for the project to the MPUC within one month. The routing process will consider potential environmental, land use, and other impacts, and provide an opportunity for the public to comment.

If additional information is desired regarding this proposed project, please contact me by email at dennis.haselhoff@dgr.com or by phone at (712) 472-2531. I look forward to hearing from you.

Sincerely,

A handwritten signature in blue ink, appearing to read "Dennis Haselhoff".

Dennis Haselhoff, P.E.
Project Engineer

Enclosures: Figure1, Figure 2



October 29, 2018

Kyle Vareberg
Administrator
Becker County Planning & Zoning
915 Lake Ave
Detroit Lakes, MN 56501

**Re: Notice of Proposed Detroit Lakes 115 kV Transmission Line Project
Detroit Lakes, MN
Detroit Lakes Public Utilities**

Dear Mr. Vareberg,

Detroit Lakes Public Utilities (DLPU) has retained DGR Engineering to assist with the permitting process on a new project to construct 2.19 miles of 115 kV transmission line in Sections 21, 28, and 33, T138N, R41W in Becker County, MN. The proposed transmission line will source a new substation located in Section 21, T138N, R41W, Becker County, MN. The proposed project is needed to provide additional capacity to the projected loads in the southern portion of the DLPU service territory. Enclosed is a map, Figure 1, showing the proposed transmission line route and substation location.

The purpose of this letter is to provide Notice of DLPU's plan to obtain a route permit from the Minnesota Public Utilities Commission (MPUC) and to request any comments that you have on the proposed project.

Project Description

The south terminus will be the existing 115 kV transmission line location in Section 33, T138N, R41W. The proposed transmission line will head north approximately 0.07 mile and cross US Highway 59. The transmission line will continue north in public right-of-way of US Highway 59 for approximately 2.12 miles. The north terminus of the proposed transmission line will be the said proposed DLPU substation. The total distance of this line will be approximately 2.19 miles.

The proposed project includes installation of overhead transmission conductors on a single, steel pole with span lengths of approximately 300'. Enclosed is a drawing, Figure 2, which shows the typical construction assembly that will be utilized.

Permitting Requirements

The proposed 115 kV transmission line meets the definition under Minn. Rules Chapter 7850.1000, subp. 9 of a High Voltage Transmission Line (HVTL). A route permit is required for the project, for which DLPU will apply.

A Certificate of Need (CON) is not required for this project because it does not classify as a large energy facility under Minn. Stat. §§216B.243 and 216B.2421, subd. 2(3). While the project is a HVTL with capacity of 100kV or more, it is not more than 10 miles long and does not cross a state line. Therefore, DLPU does not need a CON for this project.

The route permit proceeding will determine the final location of proposed facilities. As part of the permitting process, the MPUC considers input from the applicant utility, interested stakeholders, local government units, state and federal agencies, and land owners who may be affected. DLPU plans to submit an application for a route permit for the project to the MPUC within one month. The routing process will consider potential environmental, land use, and other impacts, and provide an opportunity for the public to comment.

If additional information is desired regarding this proposed project, please contact me by email at dennis.haselhoff@dgr.com or by phone at (712) 472-2531. I look forward to hearing from you.

Sincerely,

A handwritten signature in blue ink, appearing to read "Dennis Haselhoff".

Dennis Haselhoff, P.E.
Project Engineer

Enclosures: Figure1, Figure 2



October 29, 2018

Shiloh Wahl
Transportation District Engineer
Minnesota DOT District 4
1000 Highway 10 West
Detroit Lakes, MN 56501

**Re: Notice of Proposed Detroit Lakes 115 kV Transmission Line Project
Detroit Lakes, MN
Detroit Lakes Public Utilities**

Dear Mr. Wahl,

Detroit Lakes Public Utilities (DLPU) has retained DGR Engineering to assist with the permitting process on a new project to construct 2.19 miles of 115 kV transmission line in Sections 21, 28, and 33, T138N, R41W in Becker County, MN. The proposed transmission line will source a new substation located in Section 21, T138N, R41W, Becker County, MN. The proposed project is needed to provide additional capacity to the projected loads in the southern portion of the DLPU service territory. Enclosed is a map, Figure 1, showing the proposed transmission line route and substation location.

The purpose of this letter is to provide Notice of DLPU's plan to obtain a route permit from the Minnesota Public Utilities Commission (MPUC) and to request any comments that you have on the proposed project.

Project Description

The south terminus will be the existing 115 kV transmission line location in Section 33, T138N, R41W. The proposed transmission line will head north approximately 0.07 mile and cross US Highway 59. The transmission line will continue north in public right-of-way of US Highway 59 for approximately 2.12 miles. The north terminus of the proposed transmission line will be the said proposed DLPU substation. The total distance of this line will be approximately 2.19 miles.

The proposed project includes installation of overhead transmission conductors on a single, steel pole with span lengths of approximately 300'. Enclosed is a drawing, Figure 2, which shows the typical construction assembly that will be utilized.

Permitting Requirements

The proposed 115 kV transmission line meets the definition under Minn. Rules Chapter 7850.1000, subp. 9 of a High Voltage Transmission Line (HVTL). A route permit is required for the project, for which DLPU will apply.

A Certificate of Need (CON) is not required for this project because it does not classify as a large energy facility under Minn. Stat. §§216B.243 and 216B.2421, subd. 2(3). While the project is a HVTL with capacity of 100kV or more, it is not more than 10 miles long and does not cross a state line. Therefore, DLPU does not need a CON for this project.

The route permit proceeding will determine the final location of proposed facilities. As part of the permitting process, the MPUC considers input from the applicant utility, interested stakeholders, local government units, state and federal agencies, and land owners who may be affected. DLPU plans to submit an application for a route permit for the project to the MPUC within one month. The routing process will consider potential environmental, land use, and other impacts, and provide an opportunity for the public to comment.

If additional information is desired regarding this proposed project, please contact me by email at dennis.haselhoff@dgr.com or by phone at (712) 472-2531. I look forward to hearing from you.

Sincerely,

A handwritten signature in blue ink, appearing to read "Dennis Haselhoff".

Dennis Haselhoff, P.E.
Project Engineer

Enclosures: Figure1, Figure 2



October 29, 2018

Peter Fasbender
Field Office Supervisor
U.S. Fish and Wildlife Service
4101 American Boulevard East
Bloomington, MN 55425

**Re: Notice of Proposed Detroit Lakes 115 kV Transmission Line Project
Detroit Lakes, MN
Detroit Lakes Public Utilities**

Dear Mr. Fasbender,

Detroit Lakes Public Utilities (DLPU) has retained DGR Engineering to assist with the permitting process on a new project to construct 2.19 miles of 115 kV transmission line in Sections 21, 28, and 33, T138N, R41W in Becker County, MN. The proposed transmission line will source a new substation located in Section 21, T138N, R41W, Becker County, MN. The proposed project is needed to provide additional capacity to the projected loads in the southern portion of the DLPU service territory. Enclosed is a map, Figure 1, showing the proposed transmission line route and substation location.

The purpose of this letter is to provide Notice of DLPU's plan to obtain a route permit from the Minnesota Public Utilities Commission (MPUC) and to request any comments that you have on the proposed project.

Project Description

The south terminus will be the existing 115 kV transmission line location in Section 33, T138N, R41W. The proposed transmission line will head north approximately 0.07 mile and cross US Highway 59. The transmission line will continue north in public right-of-way of US Highway 59 for approximately 2.12 miles. The north terminus of the proposed transmission line will be the said proposed DLPU substation. The total distance of this line will be approximately 2.19 miles.

The proposed project includes installation of overhead transmission conductors on a single, steel pole with span lengths of approximately 300'. Enclosed is a drawing, Figure 2, which shows the typical construction assembly that will be utilized.

Permitting Requirements

The proposed 115 kV transmission line meets the definition under Minn. Rules Chapter 7850.1000, subp. 9 of a High Voltage Transmission Line (HVTL). A route permit is required for the project, for which DLPU will apply.

A Certificate of Need (CON) is not required for this project because it does not classify as a large energy facility under Minn. Stat. §§216B.243 and 216B.2421, subd. 2(3). While the project is a HVTL with capacity of 100kV or more, it is not more than 10 miles long and does not cross a state line. Therefore, DLPU does not need a CON for this project.

The route permit proceeding will determine the final location of proposed facilities. As part of the permitting process, the MPUC considers input from the applicant utility, interested stakeholders, local government units, state and federal agencies, and land owners who may be affected. DLPU plans to submit an application for a route permit for the project to the MPUC within one month. The routing process will consider potential environmental, land use, and other impacts, and provide an opportunity for the public to comment.

Federally Listed Species

According to the U.S. Fish and Wildlife Service's (USFWS) State and County Distribution list for Becker County, Minnesota, received in October of 2018, Becker county is within the overall range of the Gray Wolf (*Canis lupus*; federally threatened) and the Northern long-eared bat (*Myotis septentrionalis*; federally threatened). This project lies in Minnesota's wolf management Zone B (Federal recovery zone 5). We do not anticipate disturbing any wolf habitat as minimal disturbance of trees is anticipated in the proposed route. To minimize the possibility of disturbance of Northern long-eared bat habitat, we plan to complete this work during hibernation period (winter) when the bats are unlikely to be roosting in trees, and plan on a minimal disturbance of trees in the proposed route.

If additional information is desired regarding this proposed project, please contact me by email at dennis.haselhoff@dgr.com or by phone at (712) 472-2531. I look forward to hearing from you.

Sincerely,



Dennis Haselhoff, P.E.
DGR Engineering



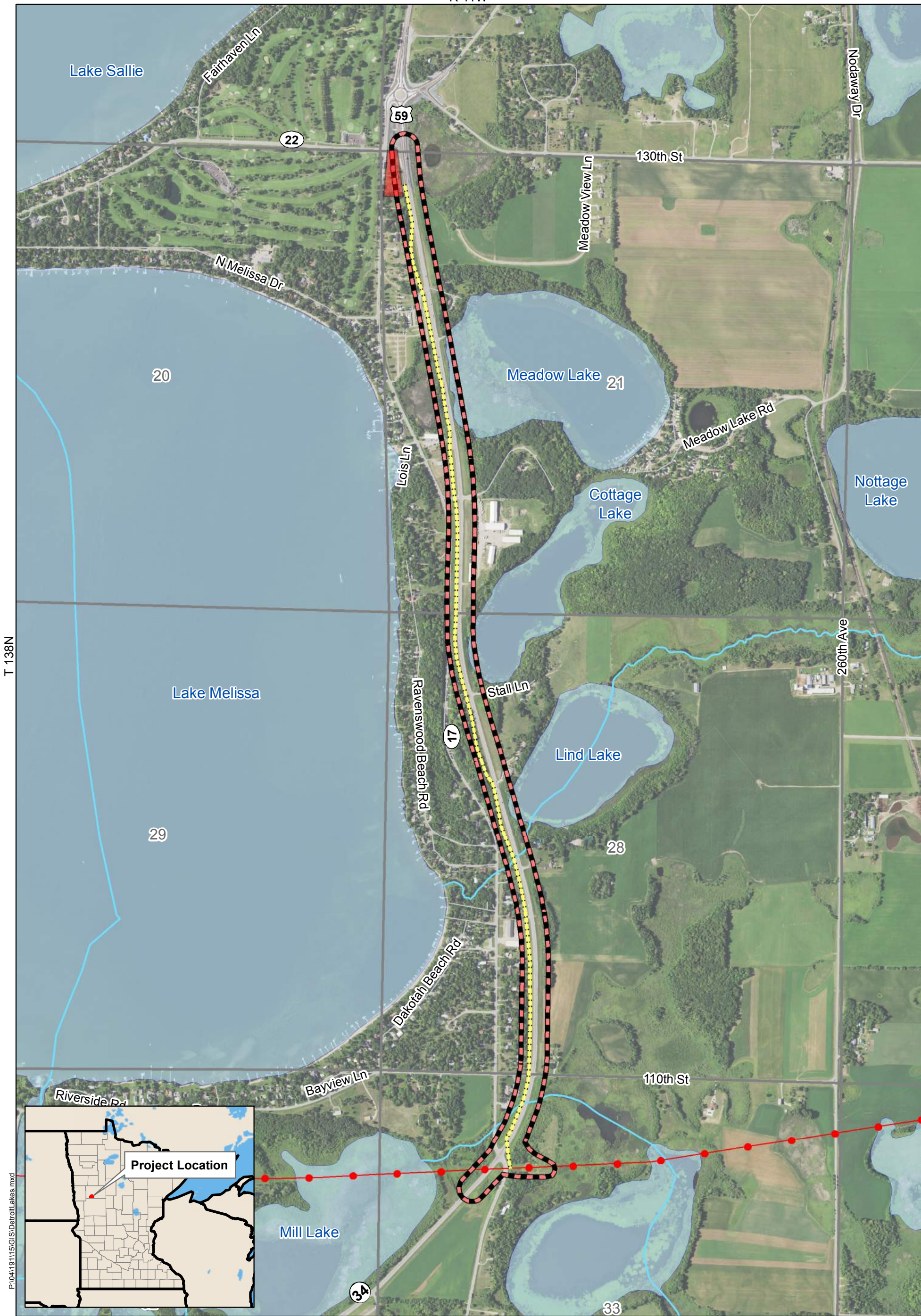

Enclosures: Figure1, Figure 2

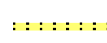

T 138N

P:\0419115\GIS\DetroitLakes.mxd

Image Source: 2017 Farm Service Agency

-  Anticipated 115kV Transmission Line Alignment
-  Proposed 115kV Route Corridor
-  Proposed 115kV Substation Site
-  Existing 115kV Transmission Line



-  Sections
- Public Waters Inventory (PWI)**
-  PWI Watercourse
-  PWI Basins



FIGURE 1
PROJECT OVERVIEW
 Proposed 115 kV Transmission Line
 Detroit Lakes Public Utilities
 Becker County, MN

115 KV
TRANSMISSION
CONDUCTORS

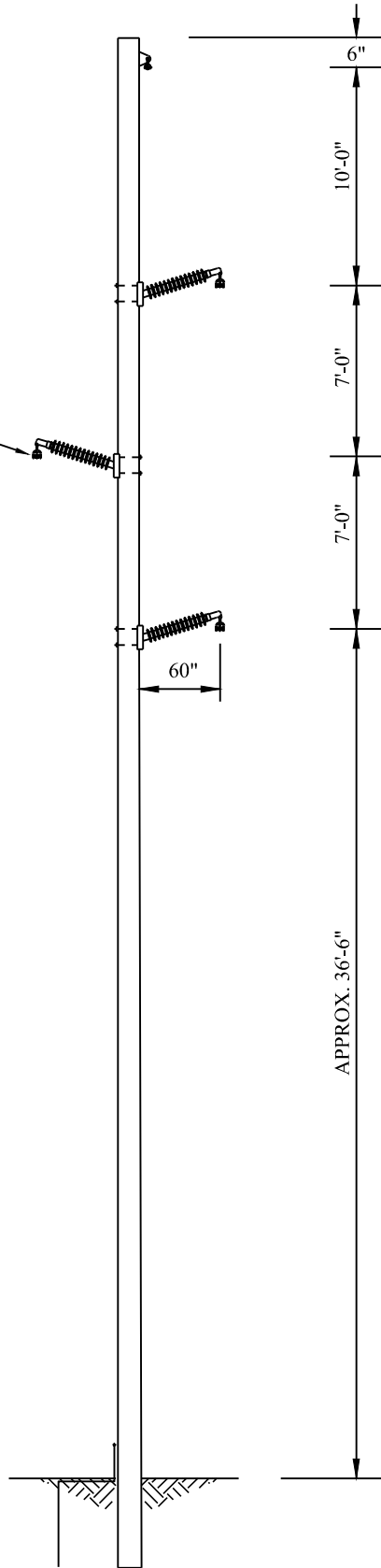

TYPICAL TANGENT STRUCTURE

REV	DATE	DESCRIPTION



Project Manager: DJH
 Designer: JDL
 Project Number: 419115
 Phone: (712) 472-2531

DETROIT LAKES PUBLIC
 UTILITIES
 DETROIT LAKES, MN

115 kV TRANSMISSION LINE
 SOUTH SUBSTATION

S
H
E
E
T
 FIGURE
 2

November 28, 2018

Mr. Dennis Haselhof, PE
DGR and Associates
1302 South Union Street
PO Box 511
Rock Rapids, IA 51246

RE: Detroit Lakes 115 kV Transmission Line Project
T138 R41 S21, 28, 33
Lake View Twp., Becker County
SHPO Number: 2019-0279

Dear Mr. Haselhof:

Thank you for the opportunity to comment on the above project. It is being reviewed pursuant to the responsibilities given the State Historic Preservation Office by the Minnesota Historic Sites Act and the Minnesota Field Archaeology Act.

Due to the nature and location of the proposed project, we recommend that a Phase I archaeological survey be completed. The survey must meet the requirements of the Secretary of the Interior's Standards for Identification and Evaluation, and should include an evaluation of National Register eligibility for any properties that are identified. For a list of consultants who have expressed an interest in undertaking such surveys, please visit the website preservationdirectory.mnhs.org, and select "Archaeologists" in the "Search by Specialties" box.

We will reconsider the need for survey if the project area can be documented as previously surveyed or disturbed. Any previous survey work must meet contemporary standards. **Note:** plowed areas and right-of-way are not automatically considered disturbed. Archaeological sites can remain intact beneath the plow zone and in undisturbed portions of the right-of-way.

Please note that this comment letter does not address the requirements of Section 106 of the National Historic Preservation Act of 1966 and 36 CFR § 800. If this project is considered for federal financial assistance, or requires a federal permit or license, then review and consultation with our office will need to be initiated by the lead federal agency. Be advised that comments and recommendations provided by our office for this state-level review may differ from findings and determinations made by the federal agency as part of review and consultation under Section 106.

If you have any questions regarding our review of this project, please contact our Environmental Review Program at (651) 201-3285.

Sincerely,

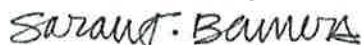

Sarah J. Beimers
Environmental Review Program Manager



Minnesota Department of Natural Resources
Division of Ecological & Water Resources
500 Lafayette Road, Box 25
St. Paul, MN 55155-4025

January 3, 2019

Correspondence # ERDB 20190191

Mr. Timothy Bents
DeWild Grant Reckert & Associates Co.
1302 South Union Street
Rock Rapids, IA 51246

RE: Natural Heritage Review of the proposed DLPU Transmission Line Project,
T138N R41W Sections 21, 28, 33; Becker County

Dear Mr. Bents,

As requested, the Minnesota Natural Heritage Information System has been queried to determine if any rare species or other significant natural features are known to occur within an approximate one-mile radius of the proposed project. Based on this query, rare features have been documented within the search area (for details, please visit the [Rare Species Guide Website](#) for more information on the biology, habitat use, and conservation measures of these rare species). Please note that the following rare features may be adversely affected by the proposed project:

- Meadow Lake has been identified as a Lake of *Moderate* Biological Significance. Lakes of Biological Significance were ranked as *Outstanding, High or Moderate* based on unique plant and animal presence. This particular lake has records of a fish species, the least darters (*Etheostoma microperca*).
 - The least darters, a state-listed fish species of special concern, was documented in 2005. This species prefers clear, low velocity lakes and streams with an abundance of submerged vegetation such as eelgrass, Canadian elodea, pondweed, and muskgrass. As this species is intolerant of environmental degradation, especially turbidity and siltation, it is important that effective erosion and sediment control practices be implemented and maintained for the duration of the project. Actions to avoid disturbance include confining activities to the west side of US Highway 59 or directionally boring under these sensitive areas. Bore pits should be placed away from the water's edge and erosion control methods should be employed to prevent excavation material from entering the water. Upon completion, pits should be filled, graded to preconstruction contours, and re-vegetated with native plant species.

- A portion of the project is adjacent to the Meadow Lake Aquatic Management Area (AMA) within T138N R41W Section 21. AMAs are established to protect, develop and manage lakes, rivers, streams, and adjacent wetlands and lands that are critical for fish and other aquatic life. As such, it is important that effective erosion prevention and sediment control practices be implemented and maintained near AMA during the duration of the project. Indirect impacts, such as the introduction or spread of invasive species, should also be considered and minimized.
- Please include a copy of this letter in any state or local license or permit application. Please note that measures to avoid or minimize disturbance to the above rare features may be included as restrictions or conditions in any required permits or licenses.

The Natural Heritage Information System (NHIS), a collection of databases that contains information about Minnesota's rare natural features, is maintained by the Division of Ecological and Water Resources, Department of Natural Resources. The NHIS is continually updated as new information becomes available, and is the most complete source of data on Minnesota's rare or otherwise significant species, native plant communities, and other natural features. However, the NHIS is not an exhaustive inventory and thus does not represent all of the occurrences of rare features within the state. Therefore, ecologically significant features for which we have no records may exist within the project area. If additional information becomes available regarding rare features in the vicinity of the project, further review may be necessary.

For environmental review purposes, the results of this Natural Heritage Review are valid for one year; the results are only valid for the project location (noted above) and the project description provided on the NHIS Data Request Form. Please contact me if project details change or for an updated review if construction has not occurred within one year.

The Natural Heritage Review does not constitute review or approval by the Department of Natural Resources as a whole. Instead, it identifies issues regarding known occurrences of rare features and potential effects to these rare features. If needed, please contact your [DNR Regional Environmental Assessment Ecologist](#) to determine whether there are other natural resource concerns associated with the proposed project. Please be aware that additional site assessments or review may be required.

Thank you for consulting us on this matter, and for your interest in preserving Minnesota's rare natural resources. An invoice will be mailed to you under separate cover.

Sincerely,



Samantha Bump
Natural Heritage Review Specialist
Samantha.Bump@state.mn.us

Links: Rare Species Guide

<http://www.dnr.state.mn.us/rsg/index.html>

DNR Regional Environmental Assessment Ecologist Contact Info

http://www.dnr.state.mn.us/eco/ereview/erp_regioncontacts.html

Lakes of Biological Significance

ftp://ftp.gisdata.mn.gov/pub/gdrs/data/pub/us_mn_state_dnr/env_lakes_of_biological_signific/metadata/lakes_of_biological_significance_criteria_20150423.pdf

Cc: Jaime Thibodeaux

Second Notice



February 8, 2019

Peter Mead
Administrator
Becker Soil & Water Conservation District
809 8th St SE
Detroit Lakes, MN 56501

**Re: Notice of Proposed Detroit Lakes 115 kV Transmission Line Project
Detroit Lakes, MN
Detroit Lakes Public Utilities**

Dear Mr. Mead,

Detroit Lakes Public Utilities (DLPU) has retained DGR Engineering to assist with the permitting process on a new project to construct 2.19 miles of 115 kV transmission line in Sections 21, 28, and 33, T138N, R41W in Becker County, MN. The proposed transmission line will source a new substation located in Section 21, T138N, R41W, Becker County, MN. The proposed project is needed to provide additional capacity to the projected loads in the southern portion of the DLPU service territory. Enclosed is a map, Figure 1, showing the proposed transmission line route and substation location.

The purpose of this letter is to provide a second notice of DLPU's plan to obtain a route permit from the Minnesota Public Utilities Commission (MPUC) and to request any comments that you have on the proposed project. *We request you respond within 30 days with project comments or acknowledgement that you have received this letter.*

Project Description

The south terminus will be the existing 115 kV transmission line location in Section 33, T138N, R41W. The proposed transmission line will head north approximately 1.04 miles and cross US Highway 59. The transmission line will continue north in public right-of-way of US Highway 59 for approximately 1.15 miles. The north terminus of the proposed transmission line will be the said proposed DLPU substation. The total distance of this line will be approximately 2.19 miles.

The proposed project includes installation of overhead transmission conductors on a single, steel pole with span lengths of approximately 300'. Enclosed is a drawing, Figure 2, which shows the typical construction assembly that will be utilized.

Permitting Requirements

The proposed 115 kV transmission line meets the definition under Minn. Rules Chapter 7850.1000, subp. 9 of a High Voltage Transmission Line ("HVTL"). A route permit is required for the project, for which DLPU has applied.

A Certificate of Need ("CON") is not required for this project because it does not classify as a large energy facility under Minn. Stat. §§216B.243 and 216B.2421, subd. 2(3). While the project is a HVTL with capacity of 100kV or more, it is not more than 10 miles long and does not cross a state line. Therefore, DLPU does not need a CON for this project.

The route permit proceeding will determine the final location of proposed facilities. As part of the permitting process, the MPUC considers input from the applicant utility, interested stakeholders, local government units, state and federal agencies, and land owners who may be affected. DLPU has already started the process for a route permit for the project to the MPUC but still values your input. The routing process will consider potential environmental, land use, and other impacts, and provide an opportunity for the public to comment.

If additional information is desired regarding this proposed project, please contact me by email at dennis.haselhoff@dgr.com or by phone at (712) 472-2531. I look forward to hearing from you.

Sincerely,

A handwritten signature in blue ink, appearing to read "Dennis Haselhoff".

Dennis Haselhoff, P.E.
Project Engineer

Enclosures: Figure1, Figure 2

Second Notice



February 8, 2019

Edward Musielewicz
District Conservationist
NRCS
809 8th St SE
Detroit Lakes, MN 56501

**Re: Notice of Proposed Detroit Lakes 115 kV Transmission Line Project
Detroit Lakes, MN
Detroit Lakes Public Utilities**

Dear Mr. Musielewicz,

Detroit Lakes Public Utilities (DLPU) has retained DGR Engineering to assist with the permitting process on a new project to construct 2.19 miles of 115 kV transmission line in Sections 21, 28, and 33, T138N, R41W in Becker County, MN. The proposed transmission line will source a new substation located in Section 21, T138N, R41W, Becker County, MN. The proposed project is needed to provide additional capacity to the projected loads in the southern portion of the DLPU service territory. Enclosed is a map, Figure 1, showing the proposed transmission line route and substation location.

The purpose of this letter is to provide a second notice of DLPU's plan to obtain a route permit from the Minnesota Public Utilities Commission (MPUC) and to request any comments that you have on the proposed project. *We request you respond within 30 days with project comments or acknowledgement that you have received this letter.*

Project Description

The south terminus will be the existing 115 kV transmission line location in Section 33, T138N, R41W. The proposed transmission line will head north approximately 1.04 miles and cross US Highway 59. The transmission line will continue north in public right-of-way of US Highway 59 for approximately 1.15 miles. The north terminus of the proposed transmission line will be the said proposed DLPU substation. The total distance of this line will be approximately 2.19 miles.

The proposed project includes installation of overhead transmission conductors on a single, steel pole with span lengths of approximately 300'. Enclosed is a drawing, Figure 2, which shows the typical construction assembly that will be utilized.

Permitting Requirements

The proposed 115 kV transmission line meets the definition under Minn. Rules Chapter 7850.1000, subp. 9 of a High Voltage Transmission Line ("HVTL"). A route permit is required for the project, for which DLPU has applied.

A Certificate of Need ("CON") is not required for this project because it does not classify as a large energy facility under Minn. Stat. §§216B.243 and 216B.2421, subd. 2(3). While the project is a HVTL with capacity of 100kV or more, it is not more than 10 miles long and does not cross a state line. Therefore, DLPU does not need a CON for this project.

The route permit proceeding will determine the final location of proposed facilities. As part of the permitting process, the MPUC considers input from the applicant utility, interested stakeholders, local government units, state and federal agencies, and land owners who may be affected. DLPU has already started the process for a route permit for the project to the MPUC but still values your input. The routing process will consider potential environmental, land use, and other impacts, and provide an opportunity for the public to comment.

If additional information is desired regarding this proposed project, please contact me by email at dennis.haselhoff@dgr.com or by phone at (712) 472-2531. I look forward to hearing from you.

Sincerely,

A handwritten signature in blue ink, appearing to read "Dennis Haselhoff".

Dennis Haselhoff, P.E.
Project Engineer

Enclosures: Figure1, Figure 2

Second Notice



February 8, 2019

Kyle Vareberg
Administrator
Becker County Planning & Zoning
915 Lake Ave
Detroit Lakes, MN 56501

**Re: Notice of Proposed Detroit Lakes 115 kV Transmission Line Project
Detroit Lakes, MN
Detroit Lakes Public Utilities**

Dear Mr. Vareberg,

Detroit Lakes Public Utilities (DLPU) has retained DGR Engineering to assist with the permitting process on a new project to construct 2.19 miles of 115 kV transmission line in Sections 21, 28, and 33, T138N, R41W in Becker County, MN. The proposed transmission line will source a new substation located in Section 21, T138N, R41W, Becker County, MN. The proposed project is needed to provide additional capacity to the projected loads in the southern portion of the DLPU service territory. Enclosed is a map, Figure 1, showing the proposed transmission line route and substation location.

The purpose of this letter is to provide a second notice of DLPU's plan to obtain a route permit from the Minnesota Public Utilities Commission (MPUC) and to request any comments that you have on the proposed project. *We request you respond within 30 days with project comments or acknowledgement that you have received this letter.*

Project Description

The south terminus will be the existing 115 kV transmission line location in Section 33, T138N, R41W. The proposed transmission line will head north approximately 1.04 miles and cross US Highway 59. The transmission line will continue north in public right-of-way of US Highway 59 for approximately 1.15 miles. The north terminus of the proposed transmission line will be the said proposed DLPU substation. The total distance of this line will be approximately 2.19 miles.

The proposed project includes installation of overhead transmission conductors on a single, steel pole with span lengths of approximately 300'. Enclosed is a drawing, Figure 2, which shows the typical construction assembly that will be utilized.

Permitting Requirements

The proposed 115 kV transmission line meets the definition under Minn. Rules Chapter 7850.1000, subp. 9 of a High Voltage Transmission Line ("HVTL"). A route permit is required for the project, for which DLPU has applied.

A Certificate of Need ("CON") is not required for this project because it does not classify as a large energy facility under Minn. Stat. §§216B.243 and 216B.2421, subd. 2(3). While the project is a HVTL with capacity of 100kV or more, it is not more than 10 miles long and does not cross a state line. Therefore, DLPU does not need a CON for this project.

The route permit proceeding will determine the final location of proposed facilities. As part of the permitting process, the MPUC considers input from the applicant utility, interested stakeholders, local government units, state and federal agencies, and land owners who may be affected. DLPU has already started the process for a route permit for the project to the MPUC but still values your input. The routing process will consider potential environmental, land use, and other impacts, and provide an opportunity for the public to comment.

If additional information is desired regarding this proposed project, please contact me by email at dennis.haselhoff@dgr.com or by phone at (712) 472-2531. I look forward to hearing from you.

Sincerely,

A handwritten signature in blue ink, appearing to read "Dennis Haselhoff".

Dennis Haselhoff, P.E.
Project Engineer

Enclosures: Figure1, Figure 2

Second Notice



February 8, 2019

Shiloh Wahl
Transportation District Engineer
Minnesota DOT District 4
1000 Highway 10 West
Detroit Lakes, MN 56501

**Re: Notice of Proposed Detroit Lakes 115 kV Transmission Line Project
Detroit Lakes, MN
Detroit Lakes Public Utilities**

Dear Mr. Wahl,

Detroit Lakes Public Utilities (DLPU) has retained DGR Engineering to assist with the permitting process on a new project to construct 2.19 miles of 115 kV transmission line in Sections 21, 28, and 33, T138N, R41W in Becker County, MN. The proposed transmission line will source a new substation located in Section 21, T138N, R41W, Becker County, MN. The proposed project is needed to provide additional capacity to the projected loads in the southern portion of the DLPU service territory. Enclosed is a map, Figure 1, showing the proposed transmission line route and substation location.

The purpose of this letter is to provide a second notice of DLPU's plan to obtain a route permit from the Minnesota Public Utilities Commission (MPUC) and to request any comments that you have on the proposed project. *We request you respond within 30 days with project comments or acknowledgement that you have received this letter.*

Project Description

The south terminus will be the existing 115 kV transmission line location in Section 33, T138N, R41W. The proposed transmission line will head north approximately 1.04 miles and cross US Highway 59. The transmission line will continue north in public right-of-way of US Highway 59 for approximately 1.15 miles. The north terminus of the proposed transmission line will be the said proposed DLPU substation. The total distance of this line will be approximately 2.19 miles.

The proposed project includes installation of overhead transmission conductors on a single, steel pole with span lengths of approximately 300'. Enclosed is a drawing, Figure 2, which shows the typical construction assembly that will be utilized.

Permitting Requirements

The proposed 115 kV transmission line meets the definition under Minn. Rules Chapter 7850.1000, subp. 9 of a High Voltage Transmission Line ("HVTL"). A route permit is required for the project, for which DLPU has applied.

A Certificate of Need ("CON") is not required for this project because it does not classify as a large energy facility under Minn. Stat. §§216B.243 and 216B.2421, subd. 2(3). While the project is a HVTL with capacity of 100kV or more, it is not more than 10 miles long and does not cross a state line. Therefore, DLPU does not need a CON for this project.

The route permit proceeding will determine the final location of proposed facilities. As part of the permitting process, the MPUC considers input from the applicant utility, interested stakeholders, local government units, state and federal agencies, and land owners who may be affected. DLPU has already started the process for a route permit for the project to the MPUC but still values your input. The routing process will consider potential environmental, land use, and other impacts, and provide an opportunity for the public to comment.

If additional information is desired regarding this proposed project, please contact me by email at dennis.haselhoff@dgr.com or by phone at (712) 472-2531. I look forward to hearing from you.

Sincerely,

A handwritten signature in blue ink, appearing to read "Dennis Haselhoff".

Dennis Haselhoff, P.E.
Project Engineer

Enclosures: Figure1, Figure 2

Second Notice



February 8, 2019

Peter Fasbender
Field Office Supervisor
U.S. Fish and Wildlife Service
4101 American Boulevard East
Bloomington, MN 55425

**Re: Notice of Proposed Detroit Lakes 115 kV Transmission Line Project
Detroit Lakes, MN
Detroit Lakes Public Utilities**

Dear Mr. Fasbender,

Detroit Lakes Public Utilities (DLPU) has retained DGR Engineering to assist with the permitting process on a new project to construct 2.19 miles of 115 kV transmission line in Sections 21, 28, and 33, T138N, R41W in Becker County, MN. The proposed transmission line will source a new substation located in Section 21, T138N, R41W, Becker County, MN. The proposed project is needed to provide additional capacity to the projected loads in the southern portion of the DLPU service territory. Enclosed is a map, Figure 1, showing the proposed transmission line route and substation location.

The purpose of this letter is to provide a second notice of DLPU's plan to obtain a route permit from the Minnesota Public Utilities Commission (MPUC) and to request any comments that you have on the proposed project. *We request you respond within 30 days with project comments or acknowledgement that you have received this letter.*

Project Description

The south terminus will be the existing 115 kV transmission line location in Section 33, T138N, R41W. The proposed transmission line will head north approximately 1.04 miles and cross US Highway 59. The transmission line will continue north in public right-of-way of US Highway 59 for approximately 1.15 miles. The north terminus of the proposed transmission line will be the said proposed DLPU substation. The total distance of this line will be approximately 2.19 miles.

The proposed project includes installation of overhead transmission conductors on a single, steel pole with span lengths of approximately 300'. Enclosed is a drawing, Figure 2, which shows the typical construction assembly that will be utilized.

Permitting Requirements

The proposed 115 kV transmission line meets the definition under Minn. Rules Chapter 7850.1000, subp. 9 of a High Voltage Transmission Line ("HVTL"). A route permit is required for the project, for which DLPU has applied.

A Certificate of Need ("CON") is not required for this project because it does not classify as a large energy facility under Minn. Stat. §§216B.243 and 216B.2421, subd. 2(3). While the project is a HVTL with capacity of 100kV or more, it is not more than 10 miles long and does not cross a state line. Therefore, DLPU does not need a CON for this project.

The route permit proceeding will determine the final location of proposed facilities. As part of the permitting process, the MPUC considers input from the applicant utility, interested stakeholders, local government units, state and federal agencies, and land owners who may be affected. DLPU has already started the process for a route permit for the project to the MPUC but still values your input. The routing process will consider potential environmental, land use, and other impacts, and provide an opportunity for the public to comment.

If additional information is desired regarding this proposed project, please contact me by email at dennis.haselhoff@dgr.com or by phone at (712) 472-2531. I look forward to hearing from you.

Sincerely,

A handwritten signature in blue ink, appearing to read "Dennis Haselhoff".

Dennis Haselhoff, P.E.
Project Engineer

Enclosures: Figure1, Figure 2

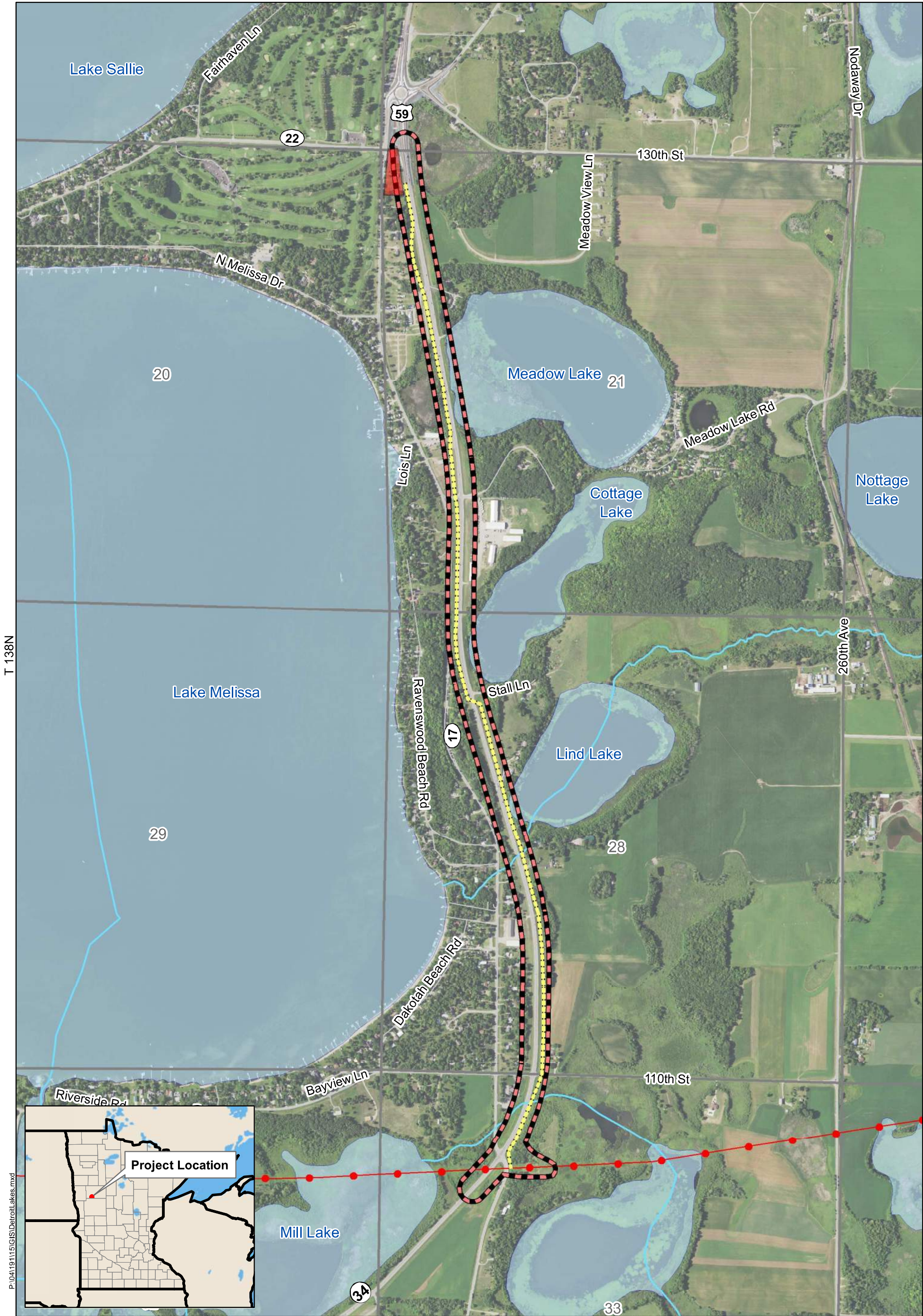

T 138N

P:\04191115\GIS\DetroitLakes.mxd

Image Source: 2017 Farm Service Agency

-  Anticipated 115kV Transmission Line Alignment
-  Proposed 115kV Route Corridor
-  Proposed 115kV Substation Site
-  Existing 115kV Transmission Line



-  Sections
- Public Waters Inventory (PWI)**
-  PWI Watercourse
-  PWI Basins



FIGURE 1
PROJECT OVERVIEW
 Proposed 115 kV Transmission Line
 Detroit Lakes Public Utilities
 Becker County, MN

115 KV
TRANSMISSION
CONDUCTORS

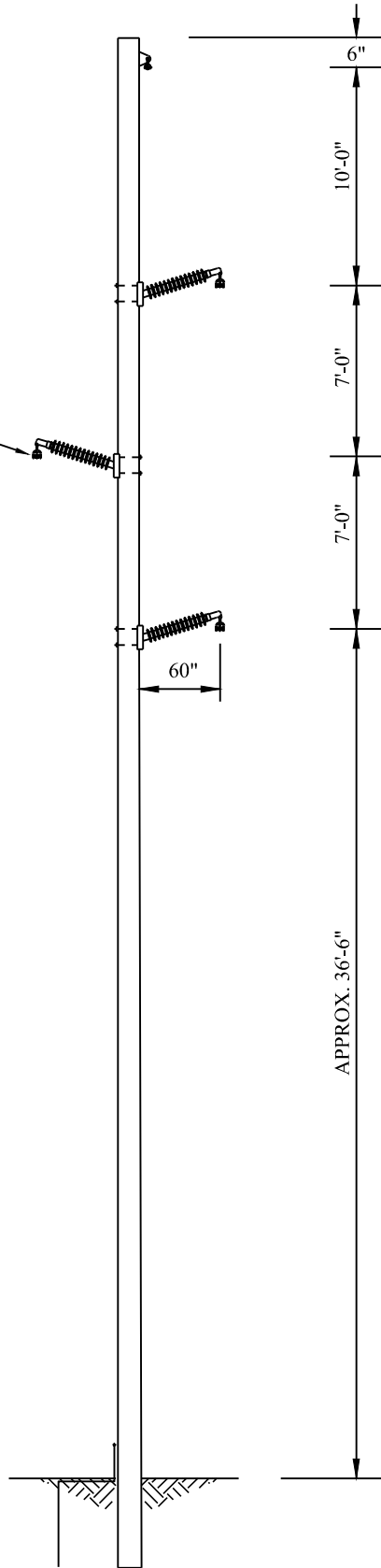

TYPICAL TANGENT STRUCTURE

REV	DATE	DESCRIPTION



Project Manager: DJH
 Designer: JDL
 Project Number: 419115
 Phone: (712) 472-2531

DETROIT LAKES PUBLIC
 UTILITIES
 DETROIT LAKES, MN

115 kV TRANSMISSION LINE
 SOUTH SUBSTATION

S
H
E
E
T
 FIGURE
 2



COUNTY OF BECKER

Planning and Zoning

915 Lake Ave, Detroit Lakes, MN 56501
Phone: 218-846-7314 ~ Fax: 218-846-7266

February 26th, 2019

Dennis Haselhoff, P.E.
Project Engineer
DGR Engineering

RE: Notice of Proposed Detroit Lakes 115 kV Transmission Line Project Detroit Lakes,
MN - Detroit Lakes Public Utilites

Dear Mr. Haselhoff:

This letter serves as a letter of acknowledgement for the noticed received by Becker County Planning and Zoning on February 8th, 2019. Given the fact the MPUC will be handling the permitting process, Becker County Planning and Zoning will not be providing any project comments at this time.

Thank you,

Kyle Vareberg

Becker County Zoning Director

From: Peter E. Mead <pemead@co.becker.mn.us>
Sent: February 13, 2019 10:54 AM
To: Dennis Haselhoff <dennis.haselhoff@dgr.com>
Cc: Ed J. Clem <ejclem@co.becker.mn.us>
Subject: Re: Notice of Proposed Detroit Lakes 115 kV Transmission Line Project

Hello Dennis,

I am writing to acknowledge receipt of your notice of the Proposed Detroit Lakes 115 kV Transmission Line Project. As the local government unit responsible for administration of the Minnesota Wetland Conservation act our concern would be that if the project poses any impact to wetlands the project be implemented according to the provisions of MN Stat. § 103G.2241, Subdivision 3 and MN Rule Chapter 8420.0420, Subpart 4. A copy of the provisions is attached for reference. Any impacts not in accordance with the above referenced statute would require a locally approved wetland replacement plan.

Cordially,

Peter Mead
District Administrator
Becker SWCD—809 8th St SE—Detroit Lakes, MN 56501
Office: 218-846-7360 Direct: 218-530-3291

pemead@co.becker.mn.us



March 7, 2019

Mr. Dennis Haselhoff
DGR Engineering
1302 South Union Street, PO Box 511
Rock Rapids IA 51246

RE: City of Detroit lakes proposed 115 Kv Transmission Line

Dear Mr. Haselhoff:

The Minnesota Department of Transportation (MnDOT) has received your letter about the proposed construction of a 115 Kv Transmission Line, within the right of way of State Trunk Highway 59, for the City of Detroit Lakes. After preliminary review MnDOT offers the following comments:

- 1) This proposed overhead transmission line would be located at the right of way line. Has your company determined whether there are any existing utilities in this area?
- 2) If there is any proposed tree cutting needed for this project, it needs to be reviewed by our Vegetation Management Unit in ST. Paul.
- 3) The proposed aerial crossing shall be a minimum of 22 feet above the roadway.

I look forward to working with your company if this project moves forward. You may send any preliminary plan sheets you develop to our permits email d4permitapps.dot@state.mn.us for review.

Please call me at (218) 846-7950 if you have any questions or comments.

Sincerely,



Jim Utecht
Mn/DOT District 4
Property Management Supervisor

cc:

Jeremy Flatau, MnDOT District 4 Right of Way Supervisor
file

Timothy Bents

From: Fasbender, Peter <peter_fasbender@fws.gov>
Sent: Wednesday, March 06, 2019 1:12 PM
To: Dennis Haselhoff
Subject: Re: [EXTERNAL] Detroit Lakes HVTL

Hi Dennis -

thank you for your patience while we reviewed this project located in Detroit Lakes, MN. I have reviewed the material you submitted and have no comments or concerns with your evaluation. Have a good day -

On Wed, Mar 6, 2019 at 7:13 AM Dennis Haselhoff <dennis.haselhoff@dgr.com> wrote:

Pete:

Thanks for returning my voicemail. As we discussed Detroit Lakes Public Utilities is proposing to construct a 115 kV HVTL near Detroit Lakes, MN. I have attached copies of the maps and letters that were sent to you via US mail. We would like a response from the US FWS regarding any potential impacts of the HVTL.

If you have any questions feel free to contact me.

Thanks.

Dennis Haselhoff, P.E.



1302 South Union Street

Rock Rapids, IA 51246

phone: 712-472-2531

cell: 712-348-2437

www.dgr.com

Trusted. Professional. Solutions.

--

Peter J. Fasbender
U.S. Fish and Wildlife Service
Minnesota and Wisconsin Ecological Services Field Office
4101 American Boulevard East
Bloomington, MN 55425
Telephone: (952) 252-0092, extension 210

Timothy Bents

From: Ingebrigtsen, Evan J CIV USARMY CEMVP (USA) <Evan.J.Ingebrigtsen@usace.army.mil>
Sent: Monday, March 25, 2019 1:05 PM
To: Timothy Bents
Subject: RE: Regional General Permit

Timothy,

Thank you for the call today. Below is a direct link to the Utility Regional General Permit we discussed. Please let me know if you have any questions.

https://www.mvp.usace.army.mil/Portals/57/docs/regulatory/RGP/Utility_RGP.pdf?ver=2018-02-22-093531-073

Here is a link to our webpage as well.

<https://www.mvp.usace.army.mil/missions/regulatory/rgp/>

Thanks,
Evan

Evan Ingebrigtsen
Project Manager
St. Paul District, Regulatory Branch
U.S. Army Corps of Engineers
10867 East Gull Lake Drive
Brainerd, MN 56401
Office: (651) 290-5765

We are pleased to introduce our new paperless communication procedures in Minnesota. Requests for action (pre-application consultations, permit applications, requests for delineation concurrences, requests for jurisdictional determinations, and mitigation bank proposals) should be sent directly to the following email: usace_requests_mn@usace.army.mil. Please include the county name in the subject line of the email (e.g. Washington County). These changes will improve efficiency, reduce costs and reduce the environmental footprint. Additional information can be found in our public notice located here: <http://www.mvp.usace.army.mil/Missions/Regulatory.aspx>

-----Original Message-----

From: Timothy Bents [<mailto:timothy.bents@dgr.com>]
Sent: Monday, March 25, 2019 11:35 AM
To: Ingebrigtsen, Evan J CIV USARMY CEMVP (USA) <Evan.J.Ingebrigtsen@usace.army.mil>
Subject: [Non-DoD Source] Regional General Permit

Evan,

Thank you for taking time to talk with me on the phone today about the proposed Detroit Lakes electrical transmission project in Becker County. If you could send me the link to the regional general permit you were talking about that would be much appreciated. I did attach a map with the proposed transmission line route for your reference.

Thanks,

Timothy Bents

GIS Specialist

1302 South Union Street

Rock Rapids, IA 51246

phone: 712-472-2531

cell: 507-360-0745

Blockedwww.dgr.com <Blockedhttp://www.dgr.com/>

Trusted. Professional. Solutions.



US Army Corps
of Engineers®
St. Paul District

DEPARTMENT OF THE ARMY

UTILITY REGIONAL GENERAL PERMIT

PERMIT: Utility Regional General Permit

ISSUING OFFICE: St. Paul District U.S. Army Corps of Engineers

EFFECTIVE DATE: February 21, 2018

EXPIRATION DATE: February 20, 2023

A. AUTHORIZATION

Regulated activities conducted in accordance with all applicable terms and conditions of the Utility Regional General Permit (RGP or permit) are authorized in the States of Wisconsin and Minnesota and on Indian Reservations in Wisconsin and Minnesota. Certain activities require an applicant to submit pre-construction notification (PCN) and receive written St. Paul District Corps of Engineers Regulatory Branch (Corps) verification prior to commencing work. Refer to the appropriate sections of this permit for a description of RGP procedures, eligible activities, conditions, exclusions and application instructions.

Unless otherwise specified in the Corps letter verifying a project complies with the terms and conditions of this RGP, the time limit for completing work authorized by the permit ends upon the expiration date of the RGP. Activities authorized under this RGP that have commenced construction or are under contract to commence construction in reliance upon this RGP, will remain authorized provided the activity is completed within 12 months of the date of the RGP expiration, suspension, or revocation; whichever is sooner.

Some RGP authorizations are not valid until a project proponent obtains a Clean Water Act Section 401 water quality certification (401 certification) or waiver from the appropriate water quality certifying agency; see general condition 30 in Section H below. Section 404, Clean Water Act regulated activities excluded from 401 certification in general condition 30 require a project-specific 401 certification or waiver from the appropriate agency. In addition, some RGP authorizations may be subject to project-specific special conditions that will be specified in the Corps verification letter. This RGP does not obviate the need for other necessary federal, state, tribal, or local authorizations or permits.

B. UTILITY REGIONAL GENERAL PERMIT APPLICABILITY

The Utility RGP applies to certain activities in waters of the United States (US), including wetlands, as described below, in the States of Wisconsin and Minnesota, including within the exterior boundaries of Indian Reservations.

- Regulatory Authorities:** Section 404 of the Clean Water Act (33 U.S.C. 1344, Section 404) for discharges of dredged and fill material into waters of the US, and Section 10 of the Rivers and Harbors Act of 1899 (33 U.S.C. 403, Section 10) for work and structures that are located in, under, or over any navigable water of the US. Activities subject to Section 404¹ and Section 10 authorization requirements are hereafter referred to as regulated activities.
- Eligible Activities:** Regulated activities associated with the five items listed below are eligible for authorization using the Utility RGP. The Utility RGP may be used to authorize losses and temporary impacts in waters of the US necessary to accomplish the activities listed below.
 - Utility Lines:** Regulated activities for single and complete linear projects to construct, maintain, or repair utility lines, including foundations for overhead utility line towers, poles, and anchors. This includes utility lines strung above, and routed in and under, Section 10 waters.

¹ Federal regulations at 33 CFR 323.4 include information about discharges which do not require Section 404 permits. These activities are not subject to the requirements of this RGP.

St. Paul District Corps of Engineers, Regulatory Branch
Utility Regional General Permit

- b. Utility Survey Activities: Temporary regulated activities for survey projects. Survey activities include core sampling, exploratory-type bore holes, exploratory trenching, soil surveys, sampling, sample plots or transects for wetland delineations, and historic resources surveys.
- c. Substation Facilities: Regulated activities for single and complete non-linear projects required to construct, maintain, or expand substation facilities.
- d. Access Roads: Regulated activities for single and complete linear projects to construct permanent and temporary access roads necessary for the construction, repair, and maintenance of utility lines and substations, and to provide access to utility survey locations.
- e. Remediation of Inadvertent Returns of Drilling Fluid: Regulated activities necessary for the remediation of inadvertent returns of drilling fluids through sub-soil fissures or fractures that might occur during directional drilling or boring activities conducted for the purpose of installing or replacing utility lines. These remediation activities must be done as soon as practicable to restore the affected waterbody. The Corps may add special conditions to RGP verifications to require a remediation plan for addressing inadvertent returns of drilling fluids to waters of the US during drilling and boring activities conducted for installing or replacing utility lines.

3. **Activity restrictions:**

- a. Regulated activities for each single and complete project cannot cause the loss of greater than 0.5 acre of waters of the US. Where a single and complete project would result in losses to more than one aquatic resource type (e.g. wetland and tributary), this restriction is calculated as the sum for all losses to aquatic resources.
- b. Regulated activities may not cause the loss of more than 300 linear feet of tributary for any single and complete project, unless the Corps waives the 300 linear foot limit by making a written determination concluding that the discharge will result in no more than minimal adverse environmental effects. An applicant may request, in writing, a waiver from the Corps. For purposes of this restriction, do not include linear ditches as defined in Section I below. Tributary losses contribute to activity restriction a. above.
- c. Regulated activities for the recovery of historic resources are not eligible for authorization as a survey activity.
- d. Regulated survey activities may not result in a loss of waters of the US.
- e. Bore holes must be properly sealed following completion of regulated survey activities.

- 4. **Pre-Construction Notification (PCN)**: Some activities eligible for Utility RGP authorization require a PCN to the Corps. Please refer to Section E below for additional information regarding PCN requirements.

NOTE: Pipes and pipelines used to transport gaseous, liquid, liquescent, or slurry substances over navigable waters of the US are considered bridges, and may require a permit from the U.S. Coast Guard pursuant to Section 9 of the Rivers and Harbors Act of 1899. Discharges of dredged and fill material into waters of the US associated with such pipes and pipelines require Section 404 authorization.

C. UTILITY REGIONAL GENERAL PERMIT EXCLUSIONS

The following activities are **INELIGIBLE** for Utility RGP authorization:

- 1. Regulated activities that would divert more than 10,000 gallons per day of surface or ground water into or out of the Great Lakes Basin.
- 2. Regulated activities that may cause more than minimal adverse effects on tribal rights (including treaty rights), protected tribal resources, or tribal lands.
- 3. Regulated activities eligible for authorization under a valid Corps Special Area Management Plan (SAMP) general permit, see <http://www.mvp.usace.army.mil/Missions/Regulatory/Permitting-Process-Procedures> for more information on SAMPs.
- 4. Regulated activities that would occur in a calcareous fen, unless the Wisconsin Department of Natural Resources (WI DNR) has authorized the proposed regulated activity, or the Minnesota Department of Natural Resources

St. Paul District Corps of Engineers, Regulatory Branch
Utility Regional General Permit

(MN DNR) has approved a calcareous fen management plan specific to the project. A list of known Minnesota calcareous fens can be found at: http://files.dnr.state.mn.us/eco/wetlands/calcareous_fen_list.pdf.

5. Regulated activities that would occur in or affect designated portions of the National Wild and Scenic River System (this includes parts of the St. Croix River in Minnesota and Wisconsin and the Wolf River in Wisconsin), or in a river officially designated by Congress as a “study river” for possible inclusion in the system while the river is in an official study status. This exclusion applies unless the appropriate Federal agency with direct management responsibility for such river has determined in writing that the proposed regulated activity will not adversely affect the Wild and Scenic River designation or study status.
6. Regulated activities which are likely to directly or indirectly jeopardize the continued existence of a federally threatened or endangered species or a species proposed for such designation, as identified under the Federal Endangered Species Act (ESA), or which will directly or indirectly destroy or adversely modify the critical habitat of such species. No regulated activity is authorized which “may affect” a listed species or critical habitat, unless ESA Section 7 consultation addressing the effects of the proposed activity has been completed.
7. Regulated activities which may have the potential to cause effects to properties listed, or eligible for listing, in the National Register of Historic Places, unless the requirements of Section 106 of the National Historic Preservation Act (NHPA) have been satisfied.
8. Regulated activities which may result in disturbance or removal of human remains unless disposition of the remains has been determined by the appropriate authority under applicable law, and the work is authorized by the Corps. See Section H, Condition 10 for more information.
9. Regulated activities which require permission from the Corps pursuant to 33 U.S.C. 408 (Section 408) because they will alter or temporarily or permanently occupy or use a Corps federally authorized civil works project, unless the appropriate Corps office issues the Section 408 permission to alter, occupy, or use the Corps federally authorized civil works project.
10. Regulated activities where applicants are unable to demonstrate that the structures, when appropriate, comply with applicable state dam safety criteria or have been designed by qualified persons.
11. Regulated activities which would adversely affect public water supplies.
12. Regulated activities, except access roads and temporary crossings required for utility line construction, repair, or maintenance, which would enclose any portion of a non-wetland water of the US.

D. CALCULATING IMPACTS TO WATERS OF THE UNITED STATES

1. **Waters of the US may include waterbodies such as streams, rivers, lakes, ponds, and wetlands** (see Definitions, Section I).
2. **Loss of waters of the US** is the sum of all permanently adversely affected jurisdictional waterbodies for a single and complete project. Temporary impacts to waters of the US, discussed below, are calculated separately from losses of waters of the US, and do not contribute to loss thresholds. Permanent adverse effects include filling, flooding, excavation, or drainage in waters of the US as a result of the regulated activity. Permanent adverse effects to waters of the US include regulated activities that change a waterbody to dry land, increase the bottom elevation of a waterbody, or decrease the bottom elevation of a waterbody (e.g. excavation of a sedge meadow wetland to shallow marsh), or change the use of a waterbody.
 - a) Losses of wetlands must be reported in either acres or square feet, as appropriate.
 - b) Losses of tributaries, ponds, and lakes must be reported in acres or square feet and linear feet below the plane of the ordinary high water mark. If regulated activities are proposed at multiple locations, they are added together to determine the total amount of linear loss to waters of the US.
 - c) Additional measurements for waterbodies may be required. If required, these measurements will be specified in the Regional General Permit Applicability, Section B, or in Pre-Construction Notification Information, Section E.

3. **Temporary impacts to waters of the US** include the sum of all regulated impacts to waters of the US for a single and complete project which are restored to pre-construction conditions after construction. Examples of temporary impacts in waters of the US include the placement of timber matting, installation of coffer dams, trenching and backfilling, and in many cases, mechanized land-clearing².
 - a) Temporary impacts to wetlands must be reported in either acres or square feet, as appropriate.
 - b) Temporary impacts to tributaries, ponds, and lakes must be reported in acres or square feet and linear feet below the plane of the ordinary high water mark. If regulated activities are proposed at multiple locations, temporary impacts must be added together to determine the total amount of temporary linear impact.
 - c) Additional measurements for waterbodies may be required. If required, these measurements will be specified in the Regional General Permit Applicability, Section B, or in Pre-Construction Notification Information, Section E.
4. **Losses and temporary impacts to waters of the US do not include:**
 - a) Activities that do not require Department of the Army authorization, such as activities eligible for exemptions under Section 404(f) of the Clean Water Act.
 - b) Impacts to linear ditches as defined in Section I, provided the ditch does not abut a wetland. Sections of ditches in or abutting wetlands do count toward loss and temporary impact thresholds.
5. The measurements of loss and temporary impact to waters of the US are for determining whether a project may qualify for the RGP, and are not reduced by compensatory mitigation.

E. PRE-CONSTRUCTION NOTIFICATION (PCN) INFORMATION

Projects that meet the terms and conditions of the Utility RGP and do not require submittal of a PCN, as outlined below, may commence work after project proponents have carefully confirmed that the activity will be conducted in compliance with all applicable terms and conditions of the Utility RGP.

Before starting regulated work, project proponents must obtain written Corps verification of Utility RGP coverage for all activities which require PCN. For Utility RGP activities that require PCN, the PCN must include all other nationwide permits, programmatic general permits, RGPs, or individual permits used or intended to be used to authorize any part of the overall project (including all single and complete projects), including other regulated activities that require authorization but do not require PCN.

Reporting requirements: For overall projects (defined in Section I) that do not require a PCN, but would result in the cumulative loss of 0.5 acre or greater of waters of the US, project proponents are required to report the overall project to the Corps. The project proponent must minimally provide items 1 through 6 below (Form and Content of PCN) to the Corps at least 30 days prior to starting work. Project proponents do not have to wait for written verification of coverage unless notified by the Corps.

² Refer to the definition of Discharge in Section I of this RGP.

St. Paul District Corps of Engineers, Regulatory Branch
Utility Regional General Permit

When PCN is required: A PCN is required for the locations, impact thresholds, and activities listed below.

<p><u>PCN is required for regulated activities proposed in these Aquatic Resources³:</u></p>	<p><u>WISCONSIN:</u></p> <ol style="list-style-type: none"> 1. Section 10 waters; 2. The Apostle Islands National Lakeshore; 3. Madeline Island; 4. State-designated wild rice waters (https://data.glifwc.org/manoomin.harvest.info); 5. Coastal plain marshes; 6. Bog wetland plant communities; 7. Interdunal wetlands; 8. Great Lakes ridge and swale complexes; 9. Fens; and 10. Wetland sites designated by the Ramsar Convention (as of the date of publication, these include: the Horicon Marsh, Upper Mississippi River Floodplain wetlands, Kakagon and Bad River Sloughs, Door County Peninsula Coastal wetlands, and the Chiwaukee Illinois Beach Lake Plain), see https://rsis Ramsar.org/. 	<p><u>MINNESOTA:</u></p> <ol style="list-style-type: none"> 1. Section 10 waters; 2. Wild rice waters identified in Minn. R. 7050.0470, subpart 1 (or as amended by the Minnesota Pollution Control Agency); 3. Bog wetland plant communities; and 4. Fens.
<p><u>PCN is required for the following activities to comply with other federal laws:</u></p>	<ol style="list-style-type: none"> 1. Regulated activities which might affect any Federally-listed threatened, endangered, or proposed threatened and endangered species, designated critical habitat, or proposed critical habitat. 2. Regulated activities which might have the potential to cause effects to any historic properties listed on, determined to be eligible for listing on, or potentially eligible for listing on the National Register of Historic Places, including previously unidentified properties. 3. Regulated activities which might result in disturbance or removal of human remains. 4. Regulated activities which require permission from the Corps pursuant to Section 408 because it will alter or temporarily or permanently occupy or use a Corps federally authorized civil works project. 5. Regulated activities proposed in or which might affect portions of rivers designated as part of the National Wild and Scenic River System, including parts of the St. Croix River in Minnesota and Wisconsin and the Wolf River in Wisconsin, or a river officially designated by Congress as a “study river” for possible inclusion in the system while the river is in an official study status. 	
<p><u>PCN is required for the following Utility RGP regulated activities:</u></p>	<ol style="list-style-type: none"> 1. All single and complete regulated activities, excluding overhead lines and construction matting, which exceed 500 linear feet in non-tributary waters of the US. 2. All single and complete projects where the regulated activity would result in the loss of greater than 0.1 acre of waters of the US. 3. All single and complete projects where the temporary impacts are proposed to impact 0.5 acre or greater of waters of the US, including wetlands. 4. Regulated activities associated with mechanized land-clearing⁴ of wooded, including both shrub and forested, wetlands. 5. Utility lines installed via trenching within a water of the United States, where the utility line runs parallel to or along a tributary contiguous with the water of the US trenched. Linear ditches (see Definitions, Section I) are not subject to this PCN requirement. 	
<p><u>Other activities which require PCN include:</u></p>	<ol style="list-style-type: none"> 1. Regulated activities in areas of suspected sediment or soil contamination, including but not limited to Superfund sites. Superfund sites in Minnesota or Wisconsin can be located by searching the EPA's website: https://www.epa.gov/superfund/search-superfund-sites-where-you-live. 2. Regulated activities impacting bridges, structures, and sunken vessels more than 50 years old, unless already determined ineligible for listing on National Register of Historic Places. Culverts that are constructed using pre-cast concrete or corrugated metal are not subject to this PCN requirement. 3. Regulated temporary impacts remaining in place for longer than 90 days between May 15 and November 15. 4. All regulated activities which require a waiver to be eligible for authorization by the Utility RGP. The Utility RGP allows waivers only for the following two regulated activities: a waiver to exceed the listed 300 linear foot tributary loss; and a waiver for duration of temporary impacts (see Section H. General Conditions). 	

³ Information about the plant communities listed can be found at www.mvp.usace.army.mil/Missions/Regulatory.aspx, www.dnr.wi.gov/topic/EndangeredResources/Communities.asp?mode=group&Type=Wetland or www.dnr.state.mn.us/npc/classification.html.

⁴ See 33 CFR 323.2 for additional information about regulated activities.

St. Paul District Corps of Engineers, Regulatory Branch
Utility Regional General Permit

Timing of PCN: Where required by the terms of this RGP, the prospective permittee must notify the Corps by submitting a PCN as early as possible. The Corps will determine if the PCN is complete within 30 calendar days of the date of receipt and, if the PCN is determined to be incomplete, notify the prospective permittee within that 30 day period to request the additional information necessary to make the PCN complete. As a general rule, the Corps will request additional information necessary to make the PCN complete only once. However, if the prospective permittee does not provide all of the requested information, then the Corps will notify the prospective permittee that the PCN is still incomplete and the PCN review process will not commence until all of the requested information has been received by the Corps.

The prospective permittee shall not begin the activity until they are notified in writing by the Corps that the activity may proceed under the RGP with any special conditions imposed by the Corps.

Form and Content of PCN: The PCN must be in writing and should utilize the Minnesota Joint Waters Wetlands Application, WI DNR application, or the Corps Application for Department of the Army Permit Form ENG 4345. A letter containing the required information may also be used. A complete PCN must include:

1. Contact information including the name, mailing address, email address, and telephone numbers of the prospective permittee and any third party agents.
2. Location of the proposed activity (i.e. section-township-range and latitude and longitude in decimal degrees).
3. A description of the proposed activity and its purpose; a description of any avoidance and minimization mitigation measures intended to reduce the adverse environmental effects caused by the proposed activity; and any and all other general or individual permits used or intended to be used to authorize any part of the overall project, including activities that require Corps authorization but do not require PCN.
4. A tabulation of all impacts to waters of the US, including the anticipated amount of loss and temporary impact to waters of the US expected to result from the proposed activity. For the Utility RGP, all PCNs must additionally report conversions of wooded (shrub and forested) communities in waters of the US. Conversion reporting in waters of the US must distinguish permanent conversion from areas proposed to regenerate, and must clarify which conversions proposed would, and would not, incorporate a regulated activity in waters of the US. Impacts to all waters of the US must be reported in acres or square feet. In addition, tributary, pond, and lake impacts must also be reported in linear feet. A table may be used to clearly and succinctly disclose this information (see Calculating Impacts to Water of the United States, Section D).
5. Sketches, maps, drawings and plans must be provided to show that the activity complies with the terms of the RGP. Sketches should contain sufficient detail to provide an illustrative description of the proposed activity. Large and small-scale maps must be provided to show the project site location. Drawings and plans should be to scale, with scale bar included, and depict all identified aquatic resources and aquatic resource impact areas, including plan-view drawings on a recent aerial photograph, and cross-section and profile drawings where appropriate.
6. Identification of all aquatic resources on the project site and the acreage of each aquatic resource present. Aquatic resources shall be identified by type (e.g. wetland, tributary, lake, man-made ditch, pond, etc.) and impacts shall be identified by type (e.g. fill, excavation, etc.) and permanence (permanent or temporary). A wetland delineation may be required.
7. A statement describing how compensatory mitigation requirements will be satisfied, or an explanation why compensatory mitigation should not be required. See Mitigation, Section F for more information.
8. If the proposed project would impact a calcareous fen, the PCN must include a copy of the WI DNR authorization for the proposed regulated activity, or a copy of the approved MN DNR calcareous fen management plan specific to the project.
9. If any federally-listed proposed, threatened or endangered species or proposed or designated critical habitat might be affected by the regulated activity, the PCN must include the name(s) of those endangered or threatened species that might be affected by the proposed activity or that utilize the designated critical habitat that might be affected by the proposed activity. Federal applicants or applicants that have federal funding (or whose project otherwise involves a lead federal agency) must provide documentation demonstrating compliance with ESA Section 7.

St. Paul District Corps of Engineers, Regulatory Branch
Utility Regional General Permit

10. If the activity might have the potential to cause effects to an historic property listed on, eligible for listing on, or potentially eligible for listing on, the National Register of Historic Places, the PCN must state which historic property might have the potential to be affected by the proposed activity and include a vicinity map indicating the location of the historic property. Federal applicants or applicants that have federal funding (or whose project otherwise involves a lead federal agency) must provide documentation demonstrating compliance with Section 106 of the NHPA.
11. If an activity is proposed in or might affect a component of the National Wild and Scenic River System (including designated portions of the St. Croix River in Minnesota and Wisconsin and the Wolf River in Wisconsin) or in a river officially designated by Congress as a “study river” for possible inclusion in the system while the river is in an official study status, the PCN must identify the Wild and Scenic River or the “study river.”
12. The PCN must specify how long temporary impacts and structures will remain in place and include a restoration plan showing how all temporary fills and structures will be removed and the area restored to pre-project conditions.
13. If a waiver from for a specific condition of the permit is proposed, the PCN must include an explanation of the need for a waiver and why the applicant believes the impacts would result in minimal individual and cumulative adverse environmental effects. The Utility RGP includes a waiver for Condition 15 (duration of temporary impacts), and the 300 linear foot tributary threshold. In addition to the information described above, any waiver request from Condition 15 requires information which describes how long the temporary impact will remain and must include a restoration plan showing how all temporary fills and structures will be removed and the area restored to pre-project conditions.
14. For an activity that requires permission from the Corps pursuant to Section 408 because it will alter or temporarily or permanently occupy or use a U.S. Army Corps of Engineers federally authorized civil works project, the PCN must include a statement confirming if the project proponent has submitted a written request for Section 408 permission from the Corps office having jurisdiction over the Corps civil works project.

F. MITIGATION

In accordance with the Federal Mitigation Rule (33 CFR part 332), the Section 404(b)(1) guidelines (40 CFR part 230), and current Corps policies and guidelines for compensatory mitigation, regulated activities must be designed and constructed to avoid and minimize (mitigate) adverse effects, both temporary and permanent, to waters of the US to the maximum extent practicable at the project site (i.e., on site). Mitigation includes actions which may avoid, minimize, rectify, reduce, or compensate for adverse environmental effects or activities which may otherwise be contrary to the public interest. Examples of avoidance activities may include installation of clear-span bridges over tributaries or excluding wetlands from additional temporary workspace. Minimization activities may include the use of construction matting in waters of the US, or seasonally restricting the timing for regulated activities within tributaries. Regulated activities which the Corps believes do not mitigate adverse environmental effects or are contrary to the public interest are ineligible for authorization by the Utility RGP, and will be evaluated by the Corps using individual permit procedures.

After all practicable steps to avoid and minimize adverse effects to waters of the US have been considered, the Corps may require compensatory mitigation to ensure that the regulated activity results in no more than minimal adverse environmental effects, or will not be contrary to the public interest. In reviewing the complete PCN for the proposed activity, the Corps will determine whether the activity authorized by the RGP will result in more than minimal individual or cumulative adverse environmental effects or may be contrary to the public interest. The Corps will issue the RGP verification for that activity if it meets the terms and conditions of that RGP, unless the Corps determines, after considering compensatory mitigation, that the proposed activity will result in more than minimal individual and cumulative adverse effects on the aquatic environment and other aspects of the public interest. When this occurs, the Corps will exercise discretionary authority to require an individual permit evaluation for the proposed regulated activity.

St. Paul District Corps of Engineers, Regulatory Branch
Utility Regional General Permit

Regulated activities eligible for this RGP which require submittal of a PCN must include a statement describing how compensatory mitigation requirements will be satisfied, or an explanation why compensatory mitigation should not be required for proposed impacts to waters of the US. Project proponents may propose the use of mitigation banks, in-lieu fee programs, or permittee-responsible mitigation. When developing a compensatory mitigation proposal, the project proponent must consider appropriate and practicable options consistent with the framework at 33 CFR 332.3(b). Compensatory mitigation projects provided to offset losses of aquatic resources must comply with the applicable provisions of the current Corps policies, guidelines, and 33 CFR 332 (the Mitigation Rule).

Information regarding current Corps policies and guidelines about compensatory mitigation in Wisconsin and Minnesota may be viewed online at www.mvp.usace.army.mil/Missions/Regulatory/Mitigation. Information regarding existing banks and in-lieu fee programs is available online at www.ribits.usace.army.mil. Nationally applicable information, including the Mitigation Rule, may be read online at http://www.usace.army.mil/Missions/Civil-Works/Regulatory-Program-and-Permits/mitig_info/.

G. USE OF MULTIPLE GENERAL PERMITS

Single and complete non-linear projects may not be “piecemealed” to avoid the limits in a general permit (nationwide, programmatic, or regional general permit). For example, multiple non-linear activities may be authorized by the Utility RGP for an overall project, provided the cumulative loss of waters of the US does not exceed 0.5 acre. To illustrate this, consider three new substations associated with an overall linear utility project, where each substation is proposed to result in a loss of 0.15 acre of waters of the US. All three substations are eligible for Utility RGP authorization because the cumulative loss to waters of the US proposed is 0.45 acre, below the 0.5 acre eligibility limit.

For an overall project, non-linear single and complete projects may be authorized in conjunction with linear single and complete projects.

When general permit limits are exceeded, projects may be eligible for review and authorization by an individual permit.

H. GENERAL CONDITIONS

To qualify for Utility regional general permit (RGP) authorization, the prospective permittee must comply with the following conditions, as applicable, in addition to any Utility RGP terms and project-specific conditions imposed by the Corps.

1. **Compliance:** The permittee is responsible for ensuring that whomever performs, supervises or oversees any portion of the physical work associated with the construction of the project has a copy of and is familiar with all the terms and conditions of the RGP and any special (permit-specific) conditions included in any written verification letter from the Corps. The activity must also comply with any special conditions added by the state, tribe, or U.S. EPA in its Section 401 Water Quality Certification, or by the state in its Coastal Zone Management Act consistency determination. The permittee is ultimately responsible for ensuring compliance with all the terms and conditions of the RGP. Any authorized structure or fill shall be properly maintained, including maintenance to ensure public safety and compliance with applicable RGP general conditions, as well as any activity-specific conditions added by the Corps to an RGP authorization.
2. **Compliance Certification:** Each permittee who receives an RGP verification letter from the Corps must provide a signed certification documenting completion of the authorized activity and implementation of any required compensatory mitigation. The Corps will provide the permittee the certification document with the RGP verification letter. The completed certification document must be submitted to the Corps within 30 days of completion of the authorized activity or the implementation of any required compensatory mitigation, whichever occurs later.

St. Paul District Corps of Engineers, Regulatory Branch
Utility Regional General Permit

3. **Site Inspection:** The permittee shall allow representatives from the Corps to inspect the proposed project site and the authorized activity to ensure that it is being, or has been, constructed and maintained in accordance with the RGP authorization.
4. **Migratory Birds and Bald and Golden Eagles:** The permittee is responsible for ensuring their action complies with the Migratory Bird Treaty Act and the Bald and Golden Eagle Protection Act. The permittee is responsible for contacting appropriate local office of the U.S. Fish and Wildlife Service (FWS) to determine applicable measures to reduce impacts to migratory birds or eagles, including whether “incidental take” permits are necessary and available under the Migratory Bird Treaty Act or Bald and Golden Eagle Protection Act for a particular activity.
5. **Endangered Species:**
 - a. No activity is authorized under this RGP which is likely to directly or indirectly jeopardize the continued existence of a federally threatened or endangered species or a species proposed for such designation, as identified under the Endangered Species Act (ESA), 50 CFR 402, or which will directly or indirectly destroy or adversely modify the critical habitat of such species. No activity is authorized under the Utility RGP which “may affect” a listed species or critical habitat, unless ESA Section 7 consultation addressing the effects of the proposed activity has been completed, and a Corps RGP verification letter is issued. Direct effects are the immediate effects on listed species and critical habitat caused by the RGP activity. Indirect effects are those effects on listed species and critical habitat that are caused by the RGP activity and are later in time, but still are reasonably certain to occur.
 - b. As a result of formal or informal consultation with the FWS, the Corps may add species-specific permit conditions to the RGP verification.
 - c. Information on the location of federally threatened and endangered species and their critical habitat can be obtained directly from the offices of the FWS on their web page at www.fws.gov/ipac.
6. **Calcareous Fens:** The permittee may not complete regulated activities in a calcareous fen, unless the Wisconsin Department of Natural Resources has authorized the proposed regulated activity, or the Minnesota Department of Natural Resources has approved a calcareous fen management plan specific to the project. A list of known Minnesota calcareous fens can be found at: http://files.dnr.state.mn.us/eco/wetlands/calcareous_fen_list.pdf.
7. **Wild and Scenic Rivers:** The permittee may not complete regulated activities which may affect or are located in a designated portions of the National Wild and Scenic River System, or in a river officially designated by Congress as a “study river” for possible inclusion in the system while the river is in an official study status, unless the appropriate Federal agency with direct management responsibility for such river, has determined in writing that the proposed activity will not adversely affect the Wild and Scenic River designation or study status.
8. **Historic Properties, Cultural Resources:**
 - a. No activity which may affect historic properties listed or potentially eligible for listing on the National Register of Historic Places is authorized until the requirements of Section 106 of the National Historic Preservation Act (Section 106) have been satisfied. Federal project proponents should follow their own procedures for complying with the requirements of Section 106 and provide documentation of compliance with those requirements.
 - b. Information on the location and existence of historic and cultural resources can be obtained from the State Historic Preservation Office, Tribal Historic Preservation Offices, and the National Register of Historic Places.
 - c. Rock or fill material used for activities authorized by this permit must either be obtained from existing quarries or, if a new borrow site is excavated to obtain fill material, the Corps must be notified prior to the use of the new site to determine whether a cultural resources survey of the site is necessary.
9. **Discovery of Previously Unknown Remains and Artifacts:** If any previously unknown historic, cultural or archeological remains and artifacts are discovered while accomplishing the activity authorized by this permit, you must immediately notify the Corps of what you have found, and to the maximum extent practicable, avoid construction activities that may affect the remains and artifacts until the required coordination has been completed. The Corps will initiate the federal, tribal, and state coordination required to determine if the items or remains warrant a recovery effort or if the site is eligible for listing in the National Register of Historic Places.

St. Paul District Corps of Engineers, Regulatory Branch
Utility Regional General Permit

10. **Burial Sites:** Burial sites, marked or unmarked, are subject to state law (Wisconsin Statute 157.70 and Minnesota Statutes 306 and 307.08). Native American burial sites on federal or tribal land are subject to the provisions of Native American Graves Protection and Repatriation Act (NAGPRA). Regulated activities may not result in disturbance or removal of human remains until disposition of the remains has been determined by the appropriate authority under these laws, and the work is authorized by the Corps. Regulated activities which result in an inadvertent discovery of human remains must stop immediately, and the Corps, as well as the appropriate state and tribal authority, must be notified. Regulated work at inadvertent discovery sites requires compliance with state law and NAGPRA, as appropriate, prior to re-starting work.
11. **Federally Authorized Corps Civil Works projects:** A permittee is not authorized to begin any regulated activities described in this RGP if activities will alter or temporarily or permanently occupy or use a Corps federally authorized civil works project, unless the appropriate Corps office issues Section 408 permission to alter, occupy, or use the Corps civil works project (pursuant to 33 U.S.C. 408), and the Corps issues written a Utility RGP verification. Examples of federal projects include, but are not limited to, works that were built by the Corps and are locally maintained (such as local flood control projects) or operated and maintained by the Corps (such as locks and dams).
12. **Dam Safety:** Permittees are not authorized to begin regulated activities unless they are able to demonstrate that the structures, when appropriate, comply with applicable state dam safety criteria or have been designed by qualified persons. The Corps may require documentation that the design has been independently reviewed by similarly qualified persons, and appropriate modifications are made to ensure safety.
13. **Suitable Material.** No activity may use unsuitable material (e.g., trash, debris, car bodies, asphalt, etc.). Material used for construction or discharged must be free from toxic pollutants in toxic amounts (see Section 307 of the Clean Water Act).
14. **Restoration of Temporary Impacts:** All temporary impacts in waters of the US, including discharges resulting from side casting material excavated from trenching, that occur as a result of the regulated activity must be fully contained with appropriate erosion control or containment methods, be restored to preconstruction contours and elevations, and, as appropriate, revegetated with native, non-invasive vegetation. In temporarily excavated wetlands, topsoil should be segregated and replaced to original depths, for example, in most wetlands the top 6 to 12 inches of the excavation should normally be backfilled with topsoil originating from the wetland. No temporary excavation area, including, but not limited to trenches, may be constructed or backfilled in such a manner as to drain waters of the United States (e.g., backfilling with extensive gravel layers, creating a French drain effect).
15. **Duration of Temporary Impacts:** Temporary impacts in waters of the U.S., including wetlands, must be avoided and limited to the smallest area and the shortest duration required to accomplish the project purpose.
 - a. Unless otherwise conditioned in a Corps RGP verification, temporary impacts may not remain in place longer than 90 days between May 15 and November 15. Before those 90 days have elapsed, all temporary discharges must be removed in their entirety.
 - b. If the temporary impacts would remain in place for longer than 90 days between May 15 and November 15, the PCN must include a request for a waiver from this condition and specify how long temporary impacts will remain and include a restoration plan showing how all temporary fills and structures will be removed and the area restored to pre-project conditions. The permittee must remove the temporary impacts in their entirety in accordance with the activity authorized their permit verification.
16. **Best Management Practices (BMPs):** To minimize adverse effects from soil loss and sediment transport that may occur as a result of the authorized work, appropriate BMPs must be implemented and maintained. For authorized work above an OHWM the BMPs must remain in place until the affected area is stabilized with vegetation or ground cover. For all authorized work below an OHWM, BMPs are required and must prevent or minimize adverse effects (e.g., total suspended solids or sedimentation) to the water column outside of the authorized work area. Heavy equipment working in wetlands or mudflats must be placed on mats, or other measures must be taken to minimize soil disturbance. All BMPs must be inspected and properly maintained following storm

St. Paul District Corps of Engineers, Regulatory Branch
Utility Regional General Permit

events to ensure they are operational. All exposed slopes and stream banks must be stabilized within 24 hours after completion of all tributary crossings.

17. **Culverts and Crossings:** Unless an RGP verification authorizes otherwise, replacement and installation of culverts or crossings authorized by an RGP are to follow (or be restored to) the natural alignment and profile of the tributary. The culverts or bridges must adequately pass low flow and bankfull events, bedload, sediment load, and provide site-appropriate fish and wildlife passage. Example design elements include recessing single culverts to accommodate natural bankfull width and adjusting additional culvert inverts at an elevation higher than the bankfull elevation.
18. **Aquatic Life Movements:** No regulated activity may substantially disrupt the necessary life cycle movements of those species of aquatic life indigenous to the waterbody, including those species that normally migrate through the area, unless the activity's primary purpose is to impound water.
19. **Spawning Areas:** Activities in spawning areas, during spawning seasons, must be avoided to the maximum extent practicable. Activities that result in the physical destruction (e.g., through excavation, fill, or downstream smothering by substantial sedimentation) of a designated or known spawning area are not authorized.
20. **Riprap:** For RGP categories that allow for the use of riprap material for bank stabilization, only rock shall be used and it must be of a size sufficient to prevent its movement from the authorized alignment by natural forces under normal or high flows.
21. **Pollutant or Hazardous Waste Spills:** The permittee is responsible for removing pollutants and hazardous materials and for minimizing any contamination resulting from a spill in accordance with all applicable state, tribal, and federal laws. In accordance with applicable state, tribal, and federal laws and regulations, if a spill of any potential pollutant or hazardous waste occurs, it is the responsibility of the permittee to immediately notify the National Response Center at 1-800-424-8802 or www.nrc.uscg.mil AND
IN WISCONSIN: the WI DNR Spills Team at 1-800-943-0003; or
IN MINNESOTA: the Minnesota State Duty Officer at 1-800-422-0798.
22. **Clean Construction Equipment:** All construction equipment must be clean prior to entering and before leaving the work site in order to prevent the spread of invasive species.
23. **Navigation:** No activity may cause more than a minimal adverse effect on navigation. Any safety lights and signals prescribed by the U.S. Coast Guard, through regulations or otherwise, must be installed and maintained at the permittee's expense on authorized facilities in navigable waters of the US. The permittee understands and agrees that, if future operations by the United States require the removal, relocation, or other alteration, of the structure or work herein authorized, or if, in the opinion of the Secretary of the Army or his authorized representative, said structure or work shall cause unreasonable obstruction to the free navigation of the navigable waters, the permittee will be required, upon due notice from the Corps, to remove, relocate, or alter the structural work or obstructions caused thereby, without expense to the United States. No claim shall be made against the United States on account of any such removal or alteration.
24. **Fills Within 100-Year Floodplains:** The regulated activity must comply with applicable FEMA-approved state or local floodplain management requirements.
25. **Access Roads:** Access roads must be sized appropriately and must be constructed in such a way to minimize adverse effects on waters of the US and elevations must be as near as practicable to pre-construction contours and elevations (e.g., at grade corduroy roads or geotextile/gravel roads). All access roads constructed in waters of the US must be properly bridged or culverted to maintain surface flows.
26. **Minimum Clearances for Aerial Lines over Navigable Waters:** The minimum clearance* for an aerial electrical power transmission line is based on the low point of the line under conditions that produce the greatest sag, taking into consideration temperature, load, wind, length or span and the type of supports. The minimum clearance for an aerial electrical power transmission line crossing navigable waters of the United States, where there is an established bridge clearance established by the U.S. Coast Guard, shall be governed by the system voltage, as indicated below:

St. Paul District Corps of Engineers, Regulatory Branch
 Utility Regional General Permit

Nominal System Voltage, in kilovolts	Minimum Clearance Above Bridge (as established by the U.S. Coast Guard)
115 and below	20 feet
138	22
161	24
230	26
350	30
500	35
700	42
750 to 765	45

*NOTE: Minimum clearance is the distance measured between the lowest point of a stationary bridge, including any infrastructure attached to underside of the bridge, and the ordinary high water mark of the navigable waters of the United States beneath the bridge.

27. **Minimum Depths for Utility Lines under Federally-Maintained Channels:** Unless otherwise conditioned in a Corps Utility RGP verification letter, all utility line crossings of federally-maintained channels (i.e., the Mississippi River) will be buried at least six (6) feet below the allowable over depth of the authorized channel, including all side slopes.
28. **Overhead Utility Line Foundations:** Foundations proposed for overhead utility lines must be the minimum size necessary and separate footings for each tower leg (rather than a large single pad) must be used where practicable.
29. **Remediation of Inadvertent Returns of Drilling Fluid:** When an inadvertent return of drilling fluids is suspected or detected in a regulated water of the U.S. the contractor shall suspend all drilling operations at the return site immediately. Work shall be undertaken immediately to contain and clean-up the inadvertent drilling fluid and minimize further migration of the drilling fluids/slurry in waters of the US. All inadvertent return sites located in waters of the U.S. shall be returned to pre-project conditions pursuant to Conditions 14 and 15. Notification must be provided consistent with Condition 21. Notification of inadvertent returns in waters of the US must also include notification to the Corps, but does not require Utility RGP verification prior to commencing remediation work.
30. **Section 401 Clean Water Act Water Quality Certification:** All regulated activities authorized by the Utility RGP pursuant to Section 404 of the Clean Water Act require Section 401 Clean Water Act certification or waiver to be considered valid.
31. **Transfer of Regional General Permit Verifications:** If the permittee sells the property associated with a regional general permit verification, the permittee may transfer the regional general permit verification to the new owner by submitting a letter to the appropriate Corps district office to validate the transfer. A copy of the regional general permit verification must be attached to the letter, and the letter must contain the following statement and signature "When the structures or work authorized by this regional general permit are still in existence at the time the property is transferred, the terms and conditions of this regional general permit, including any special conditions, will continue to be binding on the new owner(s) of the property. To validate the transfer of this regional general permit and the associated liabilities associated with compliance with its terms and conditions, have the transferee sign and date below."

 (Transferee)

 (Date)

I. DEFINITIONS

Best management practices (BMPs): Policies, practices, procedures, or structures implemented to mitigate the adverse environmental effects on surface water quality resulting from development. BMPs are categorized as structural or non-structural.

Compensatory mitigation: The restoration (re-establishment or rehabilitation), establishment (creation), enhancement, and/or in certain circumstances preservation of aquatic resources for the purposes of offsetting unavoidable adverse impacts which remain after all appropriate and practicable avoidance and minimization has been achieved.

Direct effects: Effects that are caused by the activity and occur at the same time and place.

Discharge: The term discharge of dredged material is defined at 33 CFR 323.2(d) and the term discharge of fill material is defined at 33 CFR 323.2(f).

Exploratory trenching: Temporary excavation of the upper soil profile to expose bedrock or substrate, for the purpose of mapping or sampling the exposed material.

Historic property: Any prehistoric or historic district, site (including archaeological site), building, structure, or other object included in, or eligible for inclusion in, the National Register of Historic Places maintained by the Secretary of the Interior. This term includes artifacts, records, and remains that are related to and located within such properties. The term includes properties of traditional religious and cultural importance to an Indian tribe and that meet the National Register criteria (36 CFR part 60).

Independent utility: A test to determine what constitutes a single and complete **non-linear** project in the Corps Regulatory Program. A project is considered to have independent utility if it would be constructed absent the construction of other projects in the project area. Portions of a multi-phase project that depend upon other phases of the project do not have independent utility. Phases of a project that would be constructed even if the other phases were not built can be considered as separate single and complete projects with independent utility.

Indirect effects: Effects that are caused by the activity and are later in time or farther removed in distance, but are still reasonably foreseeable.

Linear ditch: A defined channel constructed adjacent to a linear transportation facility (e.g., roads, highways, railways, trails, airport runways, and taxiways, etc.) to convey runoff from the linear facilities and from areas which drain toward the linear facilities. The term linear ditch does not include natural tributaries, relocated natural tributaries, or modified natural tributaries.

Navigable waters: Waters subject to Section 10 of the Rivers and Harbors Act of 1899. These waters are defined at 33 CFR part 329.

Ordinary high water mark (OHWM): An ordinary high water mark is a line on the shore established by the fluctuations of water and indicated by physical characteristics, or by other appropriate means that consider the characteristics of the surrounding areas.

Overall project: The aggregate of all single and complete projects related to the same purpose, including linear and non-linear projects with regulated losses and temporary impacts to waters of the US.

Practicable: Available and capable of being done after taking into consideration cost, existing technology, and logistics in light of overall project purposes.

Pre-construction notification (PCN): A request submitted by the project proponent to the Corps for confirmation that a particular activity is verified by a general permit. The request may be a permit application, letter, or similar document that includes information about the proposed work and its anticipated environmental effects. PCN may be required by the terms and conditions of this regional general permit. A PCN may be voluntarily submitted in cases where PCN is not required and the project proponent wants verification that the activity is authorized by the general permit.

Protected tribal resources: Those natural resources and properties of traditional or customary religious or cultural importance, either on or off Indian lands, retained by, or reserved by or for, Indian tribes through treaties, statutes, judicial decisions, or executive orders, including tribal trust resources.

Single and complete linear project: A linear project is a project constructed for the purpose of getting people, goods, or services from a point of origin to a terminal point, which often involves multiple crossings of one or more waterbodies at

St. Paul District Corps of Engineers, Regulatory Branch
Utility Regional General Permit

separate and distant locations. The term “single and complete project” is defined as that portion of the overall linear project proposed or accomplished by one owner/developer or partnership or other association of owners/developers that includes all crossings of a single water of the US (i.e., a single waterbody) at a specific location. For linear projects crossing a single or multiple waterbodies several times at separate and distant locations, each crossing is considered a single and complete project for purposes of this general permit authorization. However, individual channels in a braided stream or river, or individual arms of a large, irregularly shaped wetland or lake, etc., are not separate waterbodies, and crossings of such features cannot be considered separately. The definition of “single and complete linear project” does not include the term “independent utility” because each crossing of waters of the US is needed for the single and complete linear project to fulfill its purpose of transporting people, goods, and services from the point of origin to the terminal point.

Single and complete non-linear project: For non-linear projects, the term “single and complete project” is defined at 33 CFR 330.2(i) as the overall project proposed or accomplished by one owner/developer or partnership or other association of owners/developers. A single and complete non-linear project must have independent utility. Single and complete non-linear projects may not be “piecemealed” to avoid the limits in an RGP authorization. A project is considered to have independent utility if it would be constructed absent the construction of other projects in the project area. Portions of a multi-phase project that depend upon other phases of the project do not have independent utility. Phases of a project that would be constructed even if the other phases were not built can be considered as separate single and complete projects with independent utility.

Structure: An object that is arranged in a definite pattern of organization. Examples of structures include, without limitation, any pier, boat dock, boat ramp, wharf, dolphin, weir, boom, breakwater, bulkhead, revetment, riprap, jetty, artificial island, artificial reef, permanent mooring structure, power transmission line, permanently moored floating vessel, piling, aid to navigation, or any other manmade obstacle or obstruction.

Tribal lands: Any lands which are either: 1) held in trust by the United States for the benefit of any Indian tribe or individual; or 2) held by any Indian tribe or individual subject to restrictions by the United States against alienation.

Tribal rights: Those rights legally accruing to a tribe or tribes by virtue of inherent sovereign authority, unextinguished aboriginal title, treaty, statute, judicial decisions, executive order or agreement, and that give rise to legally enforceable remedies.

Tributary: For purposes of this RGP, a water that contributes flow, either directly or through another water to a traditionally navigable water or interstate water (including wetlands) and that is characterized by the presence of the physical indicators of bed and banks and ordinary high water mark. A tributary can be a natural, man-altered, or man-made water and includes waters such as rivers, streams, canals, and ditches.

Utility line: Any pipe or pipeline for the transportation of any gaseous, liquid, liquescent, or slurry substance, for any purpose not excluded herein, and any cable, line, or wire for the transmission of electrical energy, telephone, and telegraph messages, and internet, radio, and television communication. The term utility line does not include activities that drain a water of the United States, such as drainage tile or French drains. The term also excludes pipes and culverts for residential, commercial, industrial, agricultural, recreational, or other developments associated with driveways, roadways, lots, and storm water ponds.

Waiver: An approval from the Corps which allows an applicant to exceed the activity restrictions or conditions described in an RGP. Waivers may only be considered when expressly indicated as available in an RGP and will only be granted once the Corps has made a written determination that the RGP activity will result in only minimal individual and cumulative adverse environmental effects. When a waiver is required, an applicant cannot start work until they have received an RGP verification letter with waiver approval.

Waterbody: For purposes of this RGP, a waterbody is a jurisdictional water of the US. Examples of “waterbodies” include streams, rivers, lakes, ponds, and wetlands.

J. FURTHER INFORMATION

1. Congressional authorities: The permittee has been authorized to undertake the activity described above pursuant to Section 404 of the Clean Water Act (33 U.S.C 1344) and Section 10 of the Rivers and Harbors Act of 1899 (33 U.S.C. 403).
2. The Corps retains discretionary authority to require an individual permit for any activity eligible for authorization by an RGP based on concern for the aquatic environment or for any other factor of the public interest.
3. Limits of this authorization:
 - a. This RGP does not obviate the need to obtain other federal, state, or local authorizations required by law;
 - b. This RGP does not grant any property rights or exclusive privileges;
 - c. This RGP does not authorize any injury to the property or rights of others; and
 - d. This RGP does not authorize interference with any existing or proposed federal project.
4. Limits of federal liability: In issuing this permit, the Federal Government does not assume any liability for the following:
 - a. Damages to the permitted project or uses thereof as a result of other permitted or unpermitted activities or from natural causes;
 - b. Damages to the permitted project or uses thereof as a result of current or future activities undertaken by or on behalf of the United States in the public interest;
 - c. Damages to persons, property, or to other permitted or unpermitted activities or structures caused by the activity authorized by this permit;
 - d. Design or construction deficiencies associated with the permitted work; or
 - e. Damage claims associated with any future modification, suspension, or revocation of this permit.
5. Reliance on permittee's data: The determination of this office that an activity is not contrary to the public interest will be made in reliance on the information provided by the project proponent.
6. Re-evaluation of decision: This office may reevaluate its decision for an individual verification under this general permit at any time the circumstances warrant. Circumstances that could require a reevaluation include, but are not limited to, the following:
 - a. The permittee fails to comply with the terms and conditions of this permit;
 - b. The information provided by the permittee in support of the pre-construction notification proves to have been false, incomplete, or inaccurate (See 5 above); or
 - c. Significant new information surfaces which this office did not consider in reaching the original decision. Such a reevaluation may result in a determination that it is appropriate to use the suspension, modification, and revocation procedures contained in 33 CFR 325.7 or enforcement procedures such as those contained in 33 CFR 326.4 and 326.5. The referenced enforcement procedures provide for the issuance of an administrative order requiring the permittee to comply with the terms and conditions of their permit and for the initiation of legal action where appropriate. The permittee will be required to pay for any corrective measures ordered by this office, and if the permittee fails to comply with such directive, this office may in certain situations (such as those specified in 33 CFR 209.170) accomplish the corrective measures by contract or otherwise and bill the permittee for the cost.
7. This office may also reevaluate its decision to issue this Utility RGP at any time the circumstances warrant. Circumstances that could require a reevaluation include, but are not limited to, significant new information surfaces which this office did not consider in reaching the original public interest decision. Such a reevaluation may result in a determination that it is appropriate to use the suspension, modification, and revocation procedures contained in 33 CFR 325.

K. CORPS DECISION

In reviewing the PCN for the proposed activity, the Corps will determine whether the activity authorized by the RGP will result in more than minimal individual or cumulative adverse environmental effects or may be contrary to the public interest. If a project proponent requests authorization by a specific RGP, the Corps should issue the RGP verification for that activity if it meets the terms and conditions of that RGP, unless the Corps determines, after considering mitigation, that the proposed activity will result in more than minimal individual and cumulative adverse effects on the aquatic environment and other aspects of the public interest and exercises discretionary authority to require an individual permit for the proposed activity. For a linear project, this determination will include an evaluation of the individual crossings of waters of the US to determine whether they individually satisfy the terms and conditions of the RGPs, as well as the cumulative effects caused by all of the crossings authorized by RGP.

If an applicant requests a waiver for any limit where waivers are indicated as available, the Corps will only grant the waiver upon a written determination that the RGP activity will result in only minimal individual and cumulative adverse environmental effects.

When making minimal adverse environmental effects determinations the Corps will consider the direct and indirect effects caused by the RGP activity. The Corps will also consider the cumulative adverse environmental effects caused by activities authorized by the RGP and whether those cumulative adverse environmental effects are no more than minimal. The Corps will consider site specific factors, such as the environmental setting in the vicinity of the RGP activity, the type of resource that will be affected by the RGP activity, the functions provided by the aquatic resources that will be affected by the RGP activity, the degree or magnitude to which the aquatic resources perform those functions, the extent that aquatic resource functions will be lost as a result of the RGP activity (e.g., partial or complete loss), the duration of the adverse effects (temporary or permanent), the importance of the aquatic resource functions to the region (e.g., watershed or ecoregion), and mitigation required by the Corps. The Corps may add case-specific special conditions to the RGP authorization to address site-specific environmental concerns.

The Corps will consider any proposed compensatory mitigation or other mitigation measures the applicant has included in the proposal to inform decisions regarding whether the net adverse environmental effects of the proposed activity are no more than minimal. The compensatory mitigation proposal may be either conceptual or detailed. If the Corps determines that the activity complies with the terms and conditions of the RGP and that the adverse environmental effects are no more than minimal, after considering mitigation, the Corps will notify the permittee and include any activity specific conditions in the RGP verification the Corps deems necessary. Conditions for compensatory mitigation requirements must comply with the appropriate provisions at 33 CFR 332.3(k). When compensatory mitigation is required, the Corps must approve the final mitigation plan before the permittee commences work in waters of the US, unless the Corps determines that prior approval of the final mitigation plan is not practicable or not necessary to ensure timely completion of the required compensatory mitigation. If the Corps determines that the adverse environmental effects of the proposed activity are more than minimal, then the Corps will notify the applicant of next steps as described in 33 CFR 325.