



Enbridge Energy, Limited Partnership

## **Environmental Mitigation Plan**

### **Facilities**

**September 2012**

Rev 1.0



**ENVIRONMENTAL MITIGATION PLAN**

**TABLE OF CONTENTS**

**INTRODUCTION ..... 1**

**1.0 GENERAL MITIGATION MEASURES..... 3**

1.1 TEMPORARY EROSION AND SEDIMENT CONTROLS ..... 3

1.2 RIGHT-OF-WAY ACCESS ..... 3

1.3 ROAD REPAIR ..... 3

1.4 WORK AREA REQUIREMENT ..... 3

1.5 LINE LIST AND PERMITS ..... 4

1.6 UPLAND CLEARING..... 5

1.6.1 Disposal of Non-Merchantable Timber..... 5

1.6.2 Disposal of Merchantable Timber..... 5

1.6.3 Upland Grading and Stump Removal..... 5

1.6.4 Upland Topsoil Segregation ..... 5

1.6.5 Temporary Erosion and Sediment Controls..... 6

1.6.6 Noise and Dust Control ..... 7

1.7 UPLAND TRENCHING/EXCAVATION..... 7

1.7.1 Timing ..... 7

1.7.2 Piping Depth ..... 7

1.8 PIPING INSTALLATION..... 7

1.9 UPLAND BACKFILLING..... 7

1.10 WET WEATHER SHUTDOWN..... 8

1.11 CONTROLLING SPREAD OF UNDESIRABLE SPECIES..... 8

1.12 CLEANUP AND ROUGH/FINAL GRADING ..... 8

1.13 REPAIR OF DAMAGED CONSERVATION PRACTICES..... 8

1.14 FINAL STABILIZATION..... 9

**2.0 WETLAND CROSSING GENERAL REQUIREMENTS ..... 10**

2.1 WETLAND ACCESS..... 10

2.2 SPILL PREVENTION ..... 10

2.2.1 Storage of Fuels and Other Materials..... 10

2.2.2 Refueling, Fuel Handling, and Equipment Maintenance ..... 10

2.3 CLEARING ..... 11

2.3.1	Temporary Workspace in Wetlands .....	11
2.4	GRADING IN A WETLAND .....	11
2.5	RIGHT-OF-WAY STABILIZATION .....	12
2.6	TRENCHING/EXCAVATION .....	12
2.6.1	Topsoil Segregation .....	12
2.6.2	Trench Breakers .....	12
2.7	PIPING INSTALLATION .....	12
2.7.1	Temporary Erosion and Sediment Controls.....	12
2.7.2	Concrete Coating .....	12
2.8	BACKFILLING .....	13
2.9	ROUGH GRADING, CLEANUP, AND TEMPORARY RESTORATION.....	13
2.9.1	Timing .....	13
2.9.2	Temporary Stabilization.....	13
<b>3.0</b>	<b>CONSTRUCTION DEWATERING .....</b>	<b>14</b>
3.1	TRENCH/EXCAVATION DEWATERING .....	14
3.1.1	Regulatory Notification and Reporting.....	15
3.1.2	Flow Measurement.....	15
3.1.3	Water Sampling .....	15
3.2	HYDROSTATIC TEST DISCHARGES .....	15
3.2.1	Refueling .....	15
3.2.2	Permit Requirements.....	15
3.2.3	Water Sampling .....	16
3.2.4	Best Management Practices .....	16
3.2.5	Flow Measurement.....	16
<b>4.0</b>	<b>WATER APPROPRIATION .....</b>	<b>17</b>
4.1	GENERAL .....	17
4.2	WATER SOURCES .....	17
4.3	FLOW MEASUREMENT.....	17
4.4	WATER SAMPLING .....	17
4.5	REGULATORY NOTIFICATION AND REPORTING.....	17
<b>5.0</b>	<b>REVEGETATION &amp; MONITORING.....</b>	<b>18</b>
5.1	PROJECT SEED SPECIFICATIONS .....	18
5.2	TEMPORARY REVEGETATION.....	19
5.3	TIMING FOR TEMPORARY VEGETATION .....	19
5.4	TEMPORARY USE OF MULCH .....	19
5.5	PERMANENT REVEGETATION .....	20
5.6	UPLAND CONSTRUCTION AREAS .....	20

5.7	PERMANENT SEEDING OF WETLAND AREAS .....	20
5.8	SEED BED PREPARTAION AND SEEDING PROCEDURES .....	20
5.9	SEEDING METHODS .....	20
5.9.1	Drill Seeding .....	21
5.9.2	Broadcast Seeding .....	21
5.9.3	Hydro-seeding.....	21
5.10	SOIL AMENDMENTS.....	21
5.11	SEEDING PERIOD.....	21
5.12	TIMING OF FINAL SEEDING .....	22
5.13	MULCH .....	22
5.14	EROSION & SEDIMENT CONTROL .....	22
5.15	DORMANT SEEDING.....	22
5.16	MONITORING.....	23
<b>6.0</b>	<b>WINTER CONSTRUCTION .....</b>	<b>24</b>
<b>7.0</b>	<b>WASTE MANAGEMENT.....</b>	<b>25</b>
7.1	HAZARDOUS WASTES .....	25
7.2	CONCRETE WASHOUT.....	26
7.3	ABRASIVE BLAST DEBRIS .....	26

## FIGURES<sup>1</sup>

Figure 1	Typical Silt Fence Installation
Figure 2	Typical Straw Bale Installation
Figure 3	Typical Erosion Control Blanket Installation
Figure 4	Typical Staple Pattern for Erosion Control Fabric
Figure 5	Typical Biolog Installation
Figure 6	Typical Cat Tracking
Figure 7	Typical Dewatering Measures
Figure 8	Typical Straw Bale Dewatering Structure
Figure 9	Typical Wetland Crossing

---

<sup>1</sup> Site-specific plans supersede any design presented in the typical details.

## INTRODUCTION

This Environmental Mitigation Plan (EMP) outlines construction-related environmental policies, procedures, and mitigation measures developed by Enbridge Energy, Limited Partnership (Enbridge or Company) as a baseline for construction projects within Enbridge facilities (pump stations and terminals). This EMP was developed based on Enbridge's experience implementing best management practices during construction. It is intended to meet or exceed applicable federal, state, and local environmental protection and erosion control specifications and practices. The EMP is designed to address typical circumstances that may be encountered during construction. Project-specific permit conditions and/or landowner agreements may supersede general practices described in this document.

This document includes the following sections:

- Section 1.0 of the EMP describes general mitigation measures, including soil erosion and sedimentation control procedures, to be implemented during upland construction and upland restoration;
- Section 2.0 describes practices for wetland construction, crossings, and restoration;
- Section 3.0 discusses construction dewatering;
- Section 4.0 outlines water appropriation practices;
- Section 5.0 addresses revegetation measures;
- Section 6.0 addresses winter construction issues;
- Section 7.0 addresses waste management issues

Alternative construction procedures implemented in lieu of this EMP must provide an equal or greater level of protection to the environment, and must be approved in writing by Enbridge.

Unless otherwise specified, the construction Contractor (Contractor) is responsible for implementing the requirements of this EMP. Enbridge will make the requirements of the EMP and applicable environmental permits known to the Contractor. If the Contractor has questions concerning these environmental requirements, the Contractor will contact an Enbridge representative.

Enbridge will provide appropriate construction oversight to confirm Company and Contractor compliance with the measures of this EMP and requirements of applicable federal, state, and local permits. Enbridge's Environmental Inspectors (EIs) will assist the Contractor in interpreting and implementing the requirements of the EMP, and verify compliance with these procedures for the Company. Enbridge employs experienced EIs to manage unforeseen situations that are not directly addressed by the project documents. Enbridge relies on the experience and judgment of the EIs through coordination and consultations with project management staff to address those unforeseen situations should they occur in the field. The EI will be expected to use judgment in the field to interpret environmental conditions and requirements, but will not be authorized to make major modifications or changes without the prior written approval of Enbridge. The EI, in consultation with Enbridge Environment staff, will have the authority to stop activities and order corrective mitigation for actions that are not in compliance with the measures in this EMP, Landowner agreements, or environmental

permit requirements. The EI will maintain appropriate records to document compliance with these and other applicable environmental permit conditions.

This document addresses environmental related requirements. All contractors and project personnel must also comply with Enbridge's safety requirements, addressed in other project-specific and/or Enbridge documents.

## **1.0 GENERAL MITIGATION MEASURES**

### **1.1 TEMPORARY EROSION AND SEDIMENT CONTROLS**

Temporary erosion and sediment control devices (ECDs) include, but are not limited to, sediment barriers (i.e. silt fence, straw bales, biologs, etc.), stormwater diversions, mulch, and revegetation. The goal of ECDs is to minimize erosion onsite, and prevent construction-related sediment from migrating offsite into sensitive resource areas such as streams, wetlands, lakes, or drainage ditches (dry or flowing). The Contractor must, at all times, maintain erosion and sediment control structures as required in the project construction documents and as required by all applicable permits. Non-functional erosion and sediment control features must be repaired, replaced, or supplemented with functional materials within 24 hours after discovery, or as otherwise specified in the project permits.

ECDs must be installed after initial clearing but before disturbance of the soil, and must be replaced by permanent erosion controls as restoration is completed. Additional information on ECDs is provided in Section 2 - Wetland Crossing General Requirements.

### **1.2 RIGHT-OF-WAY ACCESS**

Access to the construction work area will be from public roadways and Enbridge-approved private access roads only. Enbridge is responsible for creating signs or other methods to identify approved access roads and to ensure that access is confined to only the approved roads. Vehicle tracking of soil from the construction site will be minimized by installation and implementation of Best Management Practices (BMPs) such as stone pads, timber mats, reducing equipment/vehicle access to construction work areas where practicable (offsite parking), or equivalent. Installation of stone or timber mat access pads must be in accordance with applicable permits and state/federal specifications. If such BMPs are not adequate to prevent sediment from being tracked onto public roads, street sweeping, or other equivalent means of collecting sediment, must be used. If soil is tracked onto a roadway, the Contractor must remove accumulated material from the road and deposit the material in an upland area within the approved construction workspace as soon as possible, but in no circumstances more than 24 hours after discovery. In addition, soil on roadways cannot be broomed and/or graded into the road ditch or onto the shoulder.

### **1.3 ROAD REPAIR**

The Contractor must repair private roads, lanes, and public roads damaged when moving equipment or obtaining access to the right-of-way (ROW).

### **1.4 WORK AREA REQUIREMENT**

All construction equipment and vehicles will be confined to the approved work areas. Prior to commencement of clearing or ground disturbing operations, the outer limits of the construction work areas will be marked with distinctive stakes and flagging by Enbridge. Construction activities are restricted to the approved designated areas. Other areas (pipe storage and contractor yards, borrow and disposal areas, parking areas, etc.) will be posted for use by the Contractor during construction activities.

The construction workspace for a project will vary and may include a portion of Enbridge's existing facilities, existing right-of-way corridors, new permanent corridor, and site-specific temporary workspace as defined below and shown on project-specific plans and drawings.



### **Existing Facilities**

Existing facilities (e.g., pump stations, terminals, and valve stations) are owned in fee by Enbridge. The outer boundaries of most of Enbridge's existing facilities are fenced. Project activities at the facilities must be kept within the fenced boundaries, unless workspace outside of the facility has been approved by Enbridge.

### **ROW (Permanent)**

Enbridge's existing permanent ROW varies in width and is maintained to facilitate access and aerial inspection of the pipeline system.

### **Temporary Workspace**

Construction may require site-specific Temporary Workspaces (TWS) adjacent to and contiguous with the proposed ROW/permanent corridor or existing facility (construction work areas beyond the facility boundaries or permanent corridor). TWS will typically be located in uplands adjacent to the construction work area and set at least 50-feet back from sensitive resource boundaries where site-specific field conditions allow. However, to complete work safely, Enbridge may need to locate TWS within a wetland or within the 50-foot setback from a wetland or waterbody based on site-specific conditions. Approved TWS will be identified on the construction alignment sheets and/or site plans. All TWS must be identified in the field by distinctive staking of the approved construction limits prior to clearing and grading.

Use of unauthorized workspace is prohibited without Enbridge's approval. In all cases, the size of workspaces will be kept to the minimum necessary to safely conduct work. All approved workspace locations are depicted on the construction alignment sheets.

## **1.5 LINE LIST AND PERMITS**

Where project related activities will extend outside the Enbridge-owned facilities, Enbridge will provide the Contractor with a Construction Line List (CLL) that describes special requirements (e.g., timber salvage, topsoil segregation, restoration measures, fencing requirements, etc.) as agreed upon with Landowners, provided the activity or request conforms to the project permits. The Contractor must comply with these special requirements and/or permit conditions.

The CLL reflects requirements and comments provided by Landowners; however it is not a comprehensive list of construction requirements. The CLL must be considered in conjunction with other project documents and permits. Any third party agreements between the Contractor and the landowner must be pre-approved by Enbridge and in writing.

Unless otherwise noted within this EMP, Enbridge will obtain the necessary permits for the installation of the piping. Permit requirements may be more stringent than the requirements of this EMP. In all cases, the more restrictive requirements will apply.

## **1.6 UPLAND CLEARING**

The initial stage of construction may involve the clearing of brush, trees, and tall herbaceous vegetation from the ROW or Facility, if present. Clearing may be accomplished with chain saws, mowers, and hydraulic tree-cutting equipment.

### **1.6.1 Disposal of Non-Merchantable Timber**

Unless otherwise directed by Enbridge, non-merchantable timber and slash will be disposed of by mowing, chipping, grinding, and/or hauling off site to an approved disposal facility or used in stabilizing erodible slopes or construction entrances.

Burning is not allowed in wetlands or within Enbridge's existing facilities. No chips, mulch, or mechanically cut woody debris will be stockpiled in a wetland and no upland woody debris will be disposed of in a wetland (see Section 2.3 for further information on clearing in a wetland). Non-merchantable timber may not be disposed of by placing it off the ROW. No woody debris disposal will be allowed in agricultural areas or wetlands.

### **1.6.2 Disposal of Merchantable Timber**

All merchantable timber will be managed in accordance with the contract specifications.

### **1.6.3 Upland Grading and Stump Removal**

Grading generally follows clearing and involves leveling and smoothing the approved construction work areas as necessary to create a safe, even working surface for equipment and vehicles. To facilitate proper cleanup and restoration in upland areas, tree stumps outside the excavation area will be ground no less than four-inches below normal ground surface or completely removed and hauled off to an approved disposal facility. Stumps in the excavation area will be completely removed, ground, and/or hauled off to an approved disposal facility. Topsoil and subsoil disturbed during grading operations will not be mixed with foreign material (e.g., whole stumps and brush).

### **1.6.4 Upland Topsoil Segregation**

Topsoil generally has physical and chemical properties that are conducive to good plant growth. Where present within the facilities, topsoil will be segregated from less productive subsoil materials to prevent mixing during construction. A minimum one foot of separation must be maintained between the topsoil and subsoil piles to prevent mixing. Where the one foot separation cannot be maintained, a physical barrier, such as a thick layer of straw mulch, may be used between the spoil and topsoil piles to prevent mixing. Use of the physical barrier must be reviewed and approved by Enbridge on a site-specific basis.

Topsoil segregation and handling will be performed in accordance within Enbridge plans, permit conditions, and landowner agreements. Upland areas where topsoil will be stripped will be identified in Project-specific plans, commitments, and/or permits. Where required, topsoil will be stripped to a maximum depth of 12 inches unless otherwise specified in project-specific plans. If less than 12 inches of topsoil are present, the Contractor shall attempt to segregate to the depth that is present.

### **1.6.5 Temporary Erosion and Sediment Controls**

ECDs are intended to slow the velocity of water off-site to minimize erosion, stop the movement of sediments off the approved construction work area, and prevent the deposition of sediments into sensitive resources that may be on or adjacent to the work area. ECDs typically used are silt fence and/or trenched-in and staked straw bales/biologs and other barriers such as compacted earth (e.g., drivable berms across travel ways), sand bags, rubber conveyor belt barriers, or other appropriate materials (refer to Figures 1 through 6). If temporary ECDs are removed during the day to allow equipment access, they must be reinstalled at the end of the day.

Temporary ECDs must be installed after clearing and prior to grubbing and grading activities at the base of sloped approaches to streams, wetlands, roads, and in areas where concentrated surface runoff may occur. Temporary ECDs will also be installed at the edge of the work area as needed, and/or in other areas determined by the EI to slow water leaving the site and prevent siltation of waterbodies and wetlands down slope or outside of the construction work area (e.g., swales and side slopes). Temporary ECDs will be placed across the entire construction work area at the base of slopes greater than 5 percent where the base of the slope is less than 50 feet from tile line inlets, drainage ways, wetlands, and/or waterbodies until the area is revegetated and there is no potential scouring or sediment transport to surface waters.

If silt fence is in use, when the depth of sediment reaches about one-third of the height, the sediment must be removed. Non-functional ECDs will be repaired, replaced, or supplemented with functional structures within 24 hours after discovery, or as otherwise specified in the project permits.

Temporary ECDs installed across travel lanes may be removed during active daytime construction; however, ECDs must be properly reinstalled after equipment passage, or activities in the area are completed for the day. These ECDs must also be repaired and/or replaced prior to forecasted inclement weather. The Contractor is responsible for monitoring weather conditions and adjusting resources as needed to address pending and/or existing weather conditions.

#### **Temporary Stabilization**

Installation of temporary seeding, mulch (straw or hydromulch), and erosion control mats may be required by Enbridge in certain locations if there are construction delays. The Contractor may be required by Enbridge to install temporary stabilization materials sooner based on site conditions, or as required in project permits. Temporary stabilization measures as outlined in Section 5.0 must be implemented, as necessary, to minimize erosion and for sediment control.

The Contractor must install the appropriate class of erosion control blanket in accordance with manufacture recommendations and/or state Department of Transportation specifications on slopes greater than 5 percent that would be exposed over the winter and drain to surface waters (refer to Figures 3 and 4). The Contractor must attempt to install erosion control blankets on the exposed slopes prior to snowfall; however, construction progress and/or seasonal weather variations may prevent installation prior to the first snowfall. Installation of erosion control blankets and additional BMPs, as applicable based on site conditions, is required after the first snowfall to protect slopes prior to spring melt and runoff.

## **Mulch**

Mulch will be applied as indicated in Section 5.13. If exposed soils have not been stabilized prior to freezing of the ground, and soil conditions are such that disking is still effective, crimp in straw mulch to help stabilize these areas, but on steeper slopes erosion controls blankets are still preferable.

## **Cat Tracking**

Cat tracking, also known as horizontal slope grading, may be implemented based on site conditions (sandy or silt soils) to reduce erosion potential. Cat tracking is achieved by driving a bulldozer vertically up and down the slope which results in the tracks being oriented horizontally; creating small speed bumps for water (refer to Figure 6).

### **1.6.6 Noise and Dust Control**

The Contractor must take all reasonable steps to control construction-related noise and dust near residential areas and other areas as directed by Enbridge. Control practices may include wetting the work area/spoil piles/access roads, limiting working hours in residential areas, reestablishment of vegetation and/or additional measures as appropriate based on site-specific conditions.

## **1.7 UPLAND TRENCHING/EXCAVATION**

Trenching/excavation in upland areas is typically accomplished with a backhoe excavator or a rotary wheel ditching machine. Excavated material will be side cast (stockpiled) within the approved construction work area separate from topsoil, and stored such that the area subject to erosion is minimized. Where deemed appropriate by Enbridge, the Contractor will leave plugs of soil in the ditch or will construct temporary access bridges across the trench for the emergency access. Trenches will also be sloped where started and ended to allow ramps for wildlife to escape.

### **1.7.1 Timing**

The length of time a trench is left open must be minimized to ensure that installation of the pipe and restoration of the work areas occurs in a timely fashion.

### **1.7.2 Piping Depth**

At a minimum, the piping will be buried in accordance with U.S. Department of Transportation regulations (40 CFR Part 195). The depth of cover may vary depending on state law, permit requirements, landowner agreements, and site-specific conditions (e.g., depth of drain tile).

## **1.8 PIPING INSTALLATION**

Once the trench has been inspected for proper depth and rocks or other obstructions, the welded pipe is lowered into the trench. In rocky soils, the pipe may be wrapped with a protective shielding if necessary to prevent damage to the pipe coating during backfilling. Use of foam pillows must be approved by Enbridge in advance and implemented in accordance with applicable Project permits, local/state/federal regulations, and manufactures recommendations.

## **1.9 UPLAND BACKFILLING**

Backfilling of excavated areas consists of replacing the material excavated from the trench or use of suitable backfill material that meets design specifications for other structures (e.g., buildings,

foundations, etc.). In areas where topsoil has been segregated, the subsoil will be replaced first, and the topsoil will be spread uniformly over the area from which it was removed, unless the area is to be graveled. Any dewatering must be conducted in accordance with the methods discussed in Section 3.0.

### **1.10 WET WEATHER SHUTDOWN**

During construction, certain activities may be suspended in wet soil conditions, based on consideration of the following factors:

- plasticity of the surface soil to a depth of approximately 4 to 8 inches;
- extent of surface ponding;
- extent and depth of rutting and mixing of soil horizons;
- areal extent and location of potential rutting and compaction (i.e., can traffic be rerouted around wet area); and
- type of equipment and nature of the construction operations proposed for that day.

If adverse wet weather construction impacts cannot be minimized to the satisfaction of Enbridge, the Contractor must cease work in the applicable area until Enbridge determines that site conditions are such that work may continue.

### **1.11 CONTROLLING SPREAD OF UNDESIRABLE SPECIES**

Enbridge will require that construction equipment be cleaned before arriving on site to prevent the introduction of undesirable species to the project area. It is Enbridge's intent to minimize the potential introduction and/or spread of invasive species along its right-of-way or within its facilities due to construction activities. It is not practicable for Enbridge to eradicate invasive species along its right-of-way where invasive species occur adjacent to Enbridge's right-of-way. Enbridge will minimize the potential for the establishment of invasive species by minimizing the time duration between final grading and permanent seeding. Enbridge will also control weed species within its facilities.

### **1.12 CLEANUP AND ROUGH/FINAL GRADING**

All waste materials, including litter generated by construction crews, are to be disposed of daily by the Contractor. Initial cleanup and rough grading activities may take place simultaneously. Cleanup involves removing construction debris (including litter generated by construction crews and excess rock) and large woody debris (greater than 1.5 inch diameter and/or 12 inches in length). Rough and final grading includes restoring disturbed areas as near as practicable to preconstruction conditions, returning the topsoil where topsoil has been stripped, preparing a seedbed (where applicable) for permanent seeding, installing or repairing temporary erosion control measures, repairing/replacing fences, and installing permanent erosion controls. Within facilities, rough and final grade also includes establishing final design elevations, construction of containment berms, stormwater drainage conveyances and/or collection ponds, access roads or other project designed features. All disturbed areas/slopes will be stabilized with proper erosion controls, seeded graveled in accordance with final design specifications.

### **1.13 REPAIR OF DAMAGED CONSERVATION PRACTICES**

All soil conservation practices (such as terraces, grassed waterways, etc.) that are damaged by construction will be restored to preconstruction conditions to the extent practicable.

#### **1.14 FINAL STABILIZATION**

Following the completion of construction activities, the workspace will be restored to its pre-construction conditions, as practical, or in accordance with final site design specifications. Areas with disturbed soils will be reseeded and stabilized with vegetation or will be gravel or other final surface materials. Seeding will be completed in accordance with Section 5. Temporary erosion controls will be installed and maintained until the areas are stabilized or permanent erosion controls have been installed.

## **2.0 WETLAND CROSSING GENERAL REQUIREMENTS**

Construction activities must be minimized in wetlands to the extent practicable. The Contractor will also use special construction techniques to minimize the disturbance to plants and soils and to protect wetland hydrology.

Pre-construction planning is an essential part of wetland disturbance. Requirements for working in wetlands, including construction methods, timing, erosion control, and restoration, are described in this section and in the wetland disturbance permits issued by state and federal agencies. If the Contractor considers certain parts of these procedures to be technically impractical due to site-specific engineering constraints, they may submit a request to Enbridge for approval of alternative measures. Prior to construction, the Contractor must identify alternative provisions that would provide an equal or greater level of protection to wetland ecosystems. Enbridge will review the Contractor's alternatives and consult with appropriate regulatory agencies. The Contractor must receive approval from Enbridge prior to implementing the alternatives.

The procedures in this section apply to all wetlands that will be affected by the project. These procedures require that judgment be applied in the field and will be implemented under the supervision of Enbridge and the EI. The intent of these procedures is to minimize construction-related disturbance and sedimentation of wetlands and to restore wetlands as nearly as possible to pre-existing conditions.

### **2.1 WETLAND ACCESS**

The Contractor must use the construction work area and only approved roads to access wetland areas.

### **2.2 SPILL PREVENTION**

#### **2.2.1 Storage of Fuels and Other Materials**

No storage of hazardous materials, chemicals, fuels, and lubricating oils, and no concrete coating activities will be permitted in, or within 100 feet of, any wetland unless special provisions have been implemented in accordance with Enbridge's Spill Plan and prior approval is obtained from the EI. Vehicles and equipment left on site overnight must be parked at least 100 feet from a delineated wetland unless special provisions have been implemented in accordance with Enbridge's Spill Plan, secondary containment structures are functional and properly placed, and prior approval is obtained from the EI.

#### **2.2.2 Refueling, Fuel Handling, and Equipment Maintenance**

Construction equipment will be refueled in upland areas at least 100 feet from a wetland. Where the Contractor and EI determines that conditions require construction equipment (e.g., swamp hoe, trench dewatering pumps, or portable generators) to be refueled within 100 feet of a wetland, the Contractor must follow the procedures described in Enbridge's Spill Plan and implement additional provisions based on site-specific conditions. No equipment will be washed within 100 feet of a wetland. Overnight parking of equipment is not allowed within 100 feet of a wetland unless special provisions have been implemented in accordance with Enbridge's Spill Plan and approval from the EI. Maintenance (e.g., lubricating) of construction equipment will not be allowed within the 100 foot buffer zone without approval from the EI with additional special provisions for containment.

## **2.3 CLEARING**

Clearing the construction ROW in wetlands will be similar to clearing in uplands. For construction to proceed, obstructions (e.g., trees, brush, and logs) need to be removed. Typically, low ground pressure equipment will be used, limiting disturbance to the wetland. Vegetation and trees within wetlands will be cut off at ground level, leaving existing root systems intact; clearing debris will generally be removed from the wetland for disposal. Hydro-axe debris, or similar (less than 1.5 inch diameter and/or 12 inches in length) can be left in the wetland if spread evenly in the ROW to a depth not to exceed 1 inch in thickness and in a manner, as determined by the EI, which will allow for normal revegetation. Complete removal of woody debris may be required in situations where permanent wetland impacts are approved by the respective agencies for construction of above ground facilities and the woody debris could potentially affect the final design specifications of the area. Burning is not allowed in wetlands or within Enbridge's existing facilities.

### **2.3.1 Temporary Workspace in Wetlands**

In general, Enbridge attempts to locate TWS for facility construction activities outside of wetlands wherever practicable; however, TWS may be sited in select locations with prior approval from the applicable regulatory agencies if required. Clearing of forested wetlands for TWS will be avoided as much as possible.

- Staging areas, additional spoil storage areas, and other additional work areas (TWS) will be located in upland areas at least 50 feet away from wetland boundaries (refer to Figure 9), where safe work practices or site conditions permit. If site conditions do not permit a 50-foot setback, then these areas will be located as far away from the wetland as is practicable. Vegetation will not be cleared between these areas and the wetland in any event. No construction activities including vegetation clearing or earthwork will occur between the EWS and sensitive resource areas (wetlands or waterways).
- The size of the additional workspace areas will be limited to the minimum needed to conduct the facility work.

## **2.4 GRADING IN A WETLAND**

Grading in a wetland, if required, must be conducted in a manner consistent with applicable federal, state, and local permits. For installation of facility piping or utilities, grading activities must be minimized to the extent practicable. Grading outside the trench will only be allowed where required to ensure safety and to properly restore the work area after backfilling the trench and with prior approval from Enbridge. In areas to be permanently converted from wetland, the project-specific design plans must be followed to minimize overall wetland disturbance, in accordance with project permit conditions and/or approvals.

ECDs (e.g., silt fence) must be installed across the wetland-upland boundary at the edge of the approved construction workspace, where necessary, to prevent sediment flow into the wetland. Where wetlands are adjacent to the construction workspace and the workspace slopes toward the wetlands, ECDs must be installed along the edge of the construction workspace as necessary to prevent sediment flow into the wetlands. ECDs must also be installed along the edge of the construction workspace as necessary to contain spoil and sediment within the approved workspace through wetlands.



ECDs must be maintained in proper working order to prevent the flow of sediment into wetlands from spoil piles or sloped approaches that are adjacent to the wetlands. When the depth of sediment reaches one-third of the height of a sediment barrier, the barrier will be replaced and/or the sediment removed. Non-functional sediment-control measures will be repaired, replaced, or supplemented with functional features as soon as field conditions allow, but no later than 24 hours after discovery.

## **2.5 RIGHT-OF-WAY STABILIZATION**

Tree stumps, brush riprap, imported soil, and rock fill cannot be brought in to stabilize the work area in wetlands. Where low ground pressure equipment is not used, construction activities will be accomplished from timber construction mats or equivalent means with prior approval from Enbridge (refer to Figure 9). The contractor is responsible for having a sufficient number of construction mats to perform the work. To prevent the spread of noxious and invasive plant species, timber mats must be free of soil and plant material prior to being transported onto the work site.

Subsoil from trenching or excavation activities within the immediate wetland may be placed on top of equipment mats for additional stabilization. All timber mats, construction debris, and larger woody vegetative debris (greater than 1.5 inch diameter and/or 12 inches in length) will be removed during cleanup of wetlands.

## **2.6 TRENCHING/EXCAVATION**

Excavation in wetlands typically will be accomplished using backhoe excavators. The duration of open trench must be minimized to the extent possible.

### **2.6.1 Topsoil Segregation**

When constructing in wetland areas without standing water, up to one foot of topsoil (organic layer) will be stripped from the trench line and work area, in accordance with project-specific requirements. Stripped topsoil must be stockpiled separate from trench spoil to preserve the native seed stock and will be used during restoration.

### **2.6.2 Trench Breakers**

Where the EI determines that excavation activities has the potential to drain or partially drain a wetland, trench breakers will be installed as necessary to maintain the original wetland hydrology.

## **2.7 PIPING INSTALLATION**

The following procedures are intended to minimize siltation and disturbance to wetlands during piping installation.

### **2.7.1 Temporary Erosion and Sediment Controls**

ECDs at approaches to wetlands will be installed as previously described and in accordance with the specifications presented on Figures 1 through 6.

### **2.7.2 Concrete Coating**

If required, pre-fabricated concrete weights and/or saddlebag weights will also be used to provide negative buoyancy. Concrete weights will be manufactured off-site and transported to the

construction work area. Weights will be strung along the construction work area, where necessary, until they are placed over the pipe within the excavated ditch. Limited mixing and coating activities may occur on site for coating pipe joints and concrete weight repairs according to the concrete usage specifications in Enbridge's Spill Plan. Washing equipment used for mixing, pouring, casting, or coating will not be conducted within 100 feet of any wetland and will be conducted and contained in a leak-proof containment facility or impermeable liner. Erosion and sediment controls will be installed down slope of equipment wash areas where needed to capture sediments and minimize erosion from runoff. Concrete coating on the pipe must be cured for a minimum of 3 days prior to installation in a wetland due to potential toxic effects on wetland and aquatic biota.

## **2.8 BACKFILLING**

The Contractor shall restore wetlands as near as practicable to pre-construction conditions and must make a reasonable attempt to return the subsoil to its pre-construction density. During backfilling of wetland areas, subsoil material removed from the trench during construction will be replaced so that the material is not mounded above the adjacent ground surface (undisturbed trench wall). Subsoil that exceeds the elevation of the ground adjacent to the trench will be removed from the wetland and disposed of in an upland area or an Enbridge-approved disposal site. After the trench has been backfilled with subsoil, previously segregated topsoil will be spread over the trench area and mounded no more than 12 inches above the adjacent, undisturbed soil. In unsaturated wetlands, Enbridge may specify a lower maximum mound height based on site conditions. In wetland areas where the proper permits have been obtained to allow permanent fill for facility modifications, the area will be restored in accordance with project-specific design plans.

## **2.9 ROUGH GRADING, CLEANUP, AND TEMPORARY RESTORATION**

Cleanup and rough grading activities may take place simultaneously. Cleanup typically will involve removing construction debris and replacing fences removed during construction. Rough grading will include restoring original conditions within the disturbed areas (i.e., ditch line, spoil storage areas, and equipment travel lane) and installing or repairing temporary erosion control measures.

### **2.9.1 Timing**

Cleanup and rough grading (including installation of temporary erosion control measures) will begin as soon as practical after the trench is backfilled, weather permitting.

### **2.9.2 Temporary Stabilization**

Where necessary, disturbed wetland areas will be revegetated with oats (40 lbs/acre) and/or a wetland-specific seed mix, unless standing water is prevalent or unless permanent planting or seeding with native wetland vegetation is required by applicable permits. No fertilizer, lime, or mulch will be applied in wetlands

## 3.0 CONSTRUCTION DEWATERING

### 3.1 TRENCH/EXCAVATION DEWATERING

At each location where dewatering is to be conducted, the contractor must consider the following conditions in planning the dewatering event. Prior to initiating dewatering activities, the EI must check the water discharge situation to ensure that the best management practices are applied in such a way as to minimize the potential for water containing sediment from reaching a waterbody. Furthermore, Enbridge approval is required in advance of placement of dewatering structures outside of the approved construction work area.

1. **Water Discharge Setting** – The contractor shall assess each water discharge situation to include:
  - a. Soil Type - The soil type the discharged water would flow over. The management of discharged water traveling over sandy soil is more likely to soak into the ground as compared to clay soils.
  - b. Ground Surface - The topography in the area that would influence the surface flow of the discharged water.
  - c. Adjustable Discharge rate - The flow rate of the discharged water (which may need to vary) can be managed based on the site conditions to minimize instances of water from reaching a sensitive resource area such as a wetland or waterbody. (Example - Water discharged at 500 gallons per minute may soak into the ground while if discharged at a higher flow rate would cause water to flow via overland runoff into a sensitive resource area)
  - d. Discharge Outfall - The amount of hose and number/size of pumps needed to attempt to discharge water at a location which drains away from waterbodies or wetlands.
2. **Pump Intake** - Use floating suction hose or other similar measures to prevent sediment from being sucked from bottom of trench.
3. **Overwhelming Existing Drainage** - If the discharge (assumed to be clean) does enter a stream, the flow added to the stream cannot exceed 50 percent of the peak storm event flow (to prevent adding high water volumes to a small stream channel that causes erosion due to imposing high flow conditions on the stream).
4. **Filtering Mechanism** – All dewatering discharges will be directed through a filtering device as indicated below.
  - a. Well-Vegetated Upland Area – Water can be directed to a well-vegetated upland area through a geotextile filter bag. Geotextile bags need to be sized appropriately for the discharge flow and suspended sediment particle size.
  - b. Straw Bale Dewatering Structure – Where the dewatering discharge point cannot be located in an upland area due to site conditions and/or distance, the discharge should be directed into a straw bale dewatering structure. The size of the straw bale dewatering structure is dependent on the maximum water discharge rate (refer to Figures 8). A straw bale dewatering structure should be used in conjunction with a geotextile filter bag to provide additional filtration near sensitive resource areas.

- c. Alternative dewatering methods (e.g., use of water cannons) may be approved by Enbridge on a site-specific basis.

### **3.1.1 Regulatory Notification and Reporting**

Enbridge will notify appropriate state and federal agencies as required by all permits/authorizations.

Reports regarding the volume and quality of the water withdrawn and discharged will be submitted by Enbridge, as required by the applicable permits. The Contractor will provide Enbridge with the appropriate data to determine volumes of water appropriated.

### **3.1.2 Flow Measurement**

The volume of water discharged from the trench must be recorded as required by the applicable permits. The volume may be determined using a flow meter, or other approved/acceptable method as dictated by permit stipulations.

### **3.1.3 Water Sampling**

Water discharged from trench dewatering locations may need to be sampled as required by tribal permits and/or state-issued discharge permits. If required, the Contractor will assist Enbridge in obtaining these samples and will be responsible for complying with the permit limitations.

## **3.2 HYDROSTATIC TEST DISCHARGES**

Hydrostatic testing involves filling the new piping segments or storage tanks with water acquired in accordance with applicable permits, raising the internal pressure level, and holding that pressure for a specific period of time per federal Department of Transportation specifications. Hydrostatic testing will be done to verify that there are no flaws in the pipe or welds. Water used for hydrostatic testing will be discharged back to the waterbody it was appropriated from or to an Enbridge-approved discharge location. After the hydrostatic test is completed, the line /tanks will be depressurized and the water expelled. During withdrawal and discharge, the water will be sampled as required by permits. Water volumes must be measured and recorded.

If site conditions or engineering constraints make adhering to these hydrostatic testing procedures and documentation impractical, Enbridge will propose alternative provisions to the regulatory agency issuing the NPDES permit and/or applicable tribal permits. Any such alternative will provide an equal or greater level of protection to the environment than the condition from which Enbridge or its Contractor seeks relief.

### **3.2.1 Refueling**

The operation and refueling of hydrostatic test equipment will be in accordance with the conditions outlined in Enbridge's Spill Plan.

### **3.2.2 Permit Requirements**

Hydrostatic testing will be conducted in accordance with applicable appropriation and discharge permits obtained by Enbridge. Hydrostatic test waters will not be transferred from one waterbody to another, across watersheds, or major drainage divides. Chlorinated source water will be sampled at

appropriation. If chlorine levels are at or above aquatic toxicity standards, the water will not be discharged to a surface water without proper treatment.

### **3.2.3 Water Sampling**

Water discharged from hydrostatic tests will be sampled as required by state-issued appropriation or discharge permits. Hydrostatic water discharges will comply with permit limitations as required by the applicable permit conditions. If required, the Contractor will assist Enbridge in obtaining these samples and will be responsible for complying with the permit limitations.

### **3.2.4 Best Management Practices**

Prior to hydrostatic testing, Enbridge will prepare the pipe/tanks by removing accumulated construction debris, mill scale, dirt, and dust using a cleaning pig or other applicable tools. The debris will be collected in a temporary receiver and shall be properly disposed of by the Contractor. Rinse water, if used, will be treated and disposed of in accordance with applicable permit conditions.

Following testing, the test section will be depressurized and the water will be discharged to a well-vegetated, upland area with an appropriate dewatering structure such as a geotextile filter bag and/or a hay bale structure that may or may not be lined with geotextile fabric. Direct discharges to surface waters, if allowed by permit, will be directed into an energy dissipation device such as a splash pup.

At no time will the discharge rate exceed the applicable discharge rates specified in state-issued or other discharge permits. In the event no maximum discharge rate is identified, discharges shall be monitored and adjusted as necessary to avoid scouring, erosion, or sediment transport from the discharge location.

To minimize the potential for introduction and/or spread of invasive species due to hydrostatic testing activities, Enbridge will discharge water to the same source location from which it was appropriated, where approved by permits. Municipal water will be discharged in accordance with permit conditions. If water is used to test multiple test sections, it will be relayed back to the source water through the piping for final discharge. Test water will not be discharged to a waterbody other than the appropriation source, unless coordinated and permitted through the applicable agencies.

### **3.2.5 Flow Measurement**

The total volume of water discharged will be determined with a flow meter (or equivalent), or as required by the applicable state permit. The total volume of water discharged will not exceed the volume specified in the applicable permit.

## **4.0 WATER APPROPRIATION**

### **4.1 GENERAL**

Water may be drawn from local sources, such as lakes, streams, and private or municipal wells for construction activities such as dust control, trench dewatering, and hydrostatic testing. The project will follow applicable permit conditions for the appropriation of water.

### **4.2 WATER SOURCES**

Water will only be withdrawn from sources approved by Enbridge and in accordance with applicable permits. Where water is appropriated from lakes or streams, the intake hose will be suspended off of the stream or lake bottom and equipped with a screen with less than one-inch diameter openings, or equivalent device, to prevent fish uptake. During withdrawal, adequate waterbody flow rates and volumes will be maintained to protect aquatic life and allow for downstream uses. The volume and rate of withdrawal will be monitored to comply with applicable permit conditions. No additives to the water are permitted unless written approval is received from Enbridge and applicable permits authorize such additives.

If appropriation is scheduled to occur during possible periods of low flow, including frozen conditions, a backup source will be identified.

### **4.3 FLOW MEASUREMENT**

At no time will the withdrawal rate for the water source exceed the rate specified in the applicable permits.

The Contractor must measure the withdrawal rate and total volume of water appropriated with a flow meter (or equivalent method approved by Enbridge) and provide the data to Enbridge, as required by the applicable permits.

### **4.4 WATER SAMPLING**

Where required by permit conditions, Enbridge will sample the water during appropriation. The Contractor will assist Enbridge in obtaining these samples.

### **4.5 REGULATORY NOTIFICATION AND REPORTING**

Enbridge will notify appropriate agencies of the time of appropriations if required by the state appropriations permits. Reports regarding the volume and quality of the water withdrawn will be submitted by Enbridge if required by the applicable permits.

## 5.0 REVEGETATION & MONITORING

This section was developed in conjunction with Natural Resources Conservation Service (NRCS) guidelines and/or guidance provided by other regulatory agencies. If it is found that any conditions or requirements of this section or any other supporting documents are not in compliance with any governmental law or ordinance, the applicable law or ordinance will take precedent, but will not nullify other portions of this section or supporting documentation. In addition, project-specific permit conditions and Landowner requests (with exception to wetlands) for specific seed mixes (as indicated in the project Line List) take precedence over this section.

### 5.1 PROJECT SEED SPECIFICATIONS

Seed used will be purchased on a “Pure Live Seed” (PLS) basis for seeding (both temporary and permanent) revegetation areas. Seed tags will identify:

- purity;
- germination;
- date tested;
- total weight and PLS weight;
- weed seed content; and
- seed supplier’s name and business information.

Seed will be used within 12 months of testing as required by applicable state rules and regulations. The seed tags on the seed sacks will also certify that the seed is “Noxious Weed Free”. Seed rates used on the project will be based on PLS rate, not actual weight basis. Therefore, to determine the correct application rate if not indicated on the seed tag, a correction calculation must be performed based the purity and germination. For example, a seed mix that has a specified 10 pounds PLS per acre, 95 percent germination rate, and is 80 percent pure needs to be applied at the following rate:

$$(95\% \text{ germination} \times 80\% \text{ purity})/100 = 76\% \text{ PLS}$$
$$10 \text{ pounds PLS per acre}/.76\% \text{ PLS} = 13.2 \text{ pounds per acre actual seeding rate}$$

The species components of individual mixes are subject to availability at the time of purchase. Grass species may be substituted with alternative native or non-invasive species that are included in the NRCS guidelines and subject to approval by Enbridge.

Seed tags must be collected by the contractor and provided to Enbridge during seeding activities. The tags will be reviewed by Enbridge prior to installation to ensure that the seed mix complies with Enbridge’s specifications and that it is being applied to the correct location. If bulk delivery of seed is made, the above information will still be made available to Enbridge. Off-loading/on-loading of seed will not be performed in a designated wetland area.

Legume seed (if used) will be treated with an inoculant specific to the species and in accordance with the manufacturer’s recommended rate of inoculant appropriate for the seeding method (broadcast, drill, or hydroseeding). When hydroseeding, four times the manufacturer’s recommended rate of inoculant will be used.

The Contractor's proposed seed sources must be submitted to Enbridge for review and approval prior to construction. The Contractor must also arrange for appropriate storage of the seed.

## **5.2 TEMPORARY REVEGETATION**

The primary focus of Enbridge's temporary revegetation measures is to quickly establish ground cover vegetation, minimize potential soil erosion, and minimize noxious weed establishment. Enbridge's temporary seed mix (refer to Appendix A) was developed based on recommendations from the NRCS and/or other regulatory agencies. Unless specifically requested by landowners or land managing agencies, Enbridge does not intend to establish temporary vegetation in actively cultivated land, standing water wetlands or other standing water areas, or in areas that will be permanent stabilized using gravel or other final non-vegetated surface material.

## **5.3 TIMING FOR TEMPORARY VEGETATION**

Temporary revegetation will be established in construction work areas where 14 days or more will elapse between:

- the completion of final grading at a site and the establishment of permanent vegetation; and/or,
- where there is a high risk of erosion due to site-specific soil conditions and topography.

Enbridge may require the Contractor(s) to conduct temporary seeding sooner than 14 days at site-specific locations near sensitive resource areas and/or areas prone to wind/water erosion.

Temporary vegetation should be established at any time between **March 1 and November 1**. Attempts at temporary revegetation after this date should be assessed on a site specific basis and with approval from Enbridge.

## **5.4 TEMPORARY USE OF MULCH**

Straw mulch may be used to help stabilize areas during the establishment of temporary vegetation. The contractor(s) will apply mulch during the establishment of temporary vegetation in areas:

- requested by the Landowner or land managing agency;
- specified by the applicable permits or licenses; and/or
- as requested by Enbridge.

Mulch will be free of noxious weeds as listed in applicable state laws. Certified weed-free mulch may also be required at site-specific locations. The Contractor will be responsible for identifying and acquiring sources of weed-free and certified weed-free mulch. Sources must be approved by Enbridge prior to purchase and copies of the applicable documentation must be provided to Enbridge.

Mulch used in conjunction with temporary revegetation efforts will be applied at a rate of 2 tons per acre unless otherwise stipulated by permit conditions. Mulch will be uniformly distributed by a mechanical mulch blower, or by hand in areas not accessible to the mulch blower. Strands of mulch will be a minimum of 8 inches in length to allow proper anchoring. Mulch will be anchored/crimped to a depth of 2-3 inches using a mulch-anchoring tool or disc set in the straight position to minimize loss by



wind and water, as site conditions allow. Additional erosion control measures (e.g., silt fence, erosion control blankets, hydromulch) may also be applied as previously outlined.

## **5.5 PERMANENT REVEGETATION**

Permanent vegetation will be established in areas disturbed within the construction work area (permanent easement and TWS) except in standing water wetlands and areas to be restored to non-vegetation (e.g., gravel or similar). The seed mixes for permanent seeding include native seed varieties commonly found and/or available from local seed distributors. Enbridge's seed mixes (refer to Appendix A) are selected to augment revegetation via natural recruitment from native seed stock in the topsoil and are not intended to change the natural species composition. Rates provided are assumed for a drill application and must be adjusted as discussed in Section 5.9.

## **5.6 UPLAND CONSTRUCTION AREAS**

In consulting with the NRCS and other agencies, Enbridge developed a standard upland seed mix for restoring disturbed areas affected by the project (Appendix A, Table 2). The mix includes species that will provide for effective erosion control and revegetation of the project area. This seed mix will be used by Enbridge as the standard upland mix unless an alternate seed mix is specified. This seed mix is to be used in areas that will not be stabilized using gravel or similar materials.

## **5.7 PERMANENT SEEDING OF WETLAND AREAS**

Non-standing water wetlands will be seeded with the mix provided in Appendix A, Table 3 to provide temporary cover and allowed to revegetate naturally. The natural revegetation process will be encouraged by the seeds and rhizomes in the topsoil spread back over the right-of-way after pipe installation. No fertilizer, lime, or mulch will be applied in wetlands.

## **5.8 SEED BED PREPARATION AND SEEDING PROCEDURES**

In areas to be revegetated, deep tillage will be performed (as directed by Enbridge) following final grading to relieve soil compaction and promote root penetration. The soil will then be tilled to a minimum depth of 4 inches with a disc, field cultivator, or chisel plow (or equivalent) to prepare a seedbed, breaking up large clods and firm the soil surface. The resulting seedbed must be soft enough to permit seed to be covered and mulch to be anchored, yet firm enough to support the weight of an adult without sinking into the soil more than about 1/2 inch. Tillage and equipment operations related to seeding and mulching will be performed parallel to ground contours as much as practicable. Fertilizer and other soil amendments will be incorporated into the soil during seedbed preparation as specified by Enbridge in the project-specific Line List requirements and permits. No soil amendments will be applied in wetlands unless directed by the appropriate agencies.

Seed will be sown at a depth of 1/4 inch in loamy and clayey soils, and 1/2 inch deep in sandy soils.

## **5.9 SEEDING METHODS**

Seed will be applied uniformly at specified rates across the prepared ROW by drilling, broadcasting, or hydroseeding. Seeding activities will be suspended if conditions are such that equipment will cause rutting of the surface in the designated seeding areas. Enbridge will continue to monitor ROW conditions to resume seeding activities as site conditions improve and according to the general seeding timing restrictions listed in Section 5.11.

### 5.9.1 Drill Seeding

Seeding equipment will be capable of uniformly distributing the seed and sowing it at the required depth. Drills will be equipped with a feeding mechanism that will provide a uniform flow of seed at the desired application rate. Double-disc furrow openers equipped with depth bands and packer wheels to firm the soil over the seed will be used where practicable.

### 5.9.2 Broadcast Seeding

Broadcast seeding rate will be double the drill-seeding rate. Seed will be uniformly distributed by a mechanical or hand operated seeder. Following seeding, a cultipacker, harrow, or hand rake will be used to cover the seeds and firm the seedbed as is appropriate for the area.

### 5.9.3 Hydro-seeding

Hydro-seeding rate will be double the drill seeding rate, or the same as broadcast seeding rate. Seed will be applied alone or in a seed, fertilizer and/or hydro-mulch slurry. If seeding is applied alone, the amount of hydro-mulch material will be adjusted to the seed slurry to show where seeding has taken place, providing a means to identify uniform cover of the ROW. Hydro-seeders must provide continuous agitation and be capable of supplying a continuous, non-fluctuating flow of slurry. Hydro-seed slurry will not be held in the tank more than 1 hour before use. All hydro-mulch products used must be pre-approved by Enbridge and be on the applicable state Department of Transportation product list.

## 5.10 SOIL AMENDMENTS

Enbridge will consult with NRCS representatives and review county soil survey information to assess where soil amendments, specifically the application of fertilizer or lime are needed to promote successful revegetation. Soil amendments may be applied to agricultural, pasture, and/or residential lands if requested by landowners and/or land managing agencies. Enbridge will apply phosphate free fertilizers to areas within 100 feet of a waterway if soil amendments are required.

## 5.11 SEEDING PERIOD

Seeding periods have been established in consultation with local and state agencies that have knowledge of the best times to establish vegetation in the construction area. Date of seeding is a critical factor to determine the success of the revegetation effort. Seed should be applied as early as possible within the given seeding periods once favorable soil conditions have been attained. These seeding windows have been developed in consultation with the NRCS and local/regional seed suppliers for normal average growing seasons, in conjunction with normal climate and soils conditions for maximum seed germination.

Seeding Periods	
<b>Spring Permanent Seeding</b>	<b>Fall Dormant Seeding</b>
April 1 to June 15	Soil temperature below 55 degrees Fahrenheit

Enbridge will delay seeding during frozen ground conditions until the applicable spring seeding period or will complete dormant seeding where conditions allow (i.e., no snow cover). Enbridge will install temporary erosion controls during frozen conditions.

### **5.12 TIMING OF FINAL SEEDING**

Upon final grading of the ROW, and upon the restoration of wetland and waterways, seeding and restoration/stabilization will occur within 48 hours. Other methods of stabilization will be used if temporary seeding is not appropriate (e.g., mulch, erosion control matting).

### **5.13 MULCH**

Straw mulch will be applied to disturbed areas (except for actively cultivated land and wetlands) if requested by the Landowner or land managing agency, if specified by the applicable permits or licenses, or as requested by Enbridge. Mulch will specifically be required on:

- Slopes greater than 5 percent; and
- Dry, sandy areas that can blow or wash away (field decision).

Mulch will be free of noxious weeds as listed in applicable state laws. Certified weed-free mulch may also be required at site-specific locations. The Contractor will be responsible for identifying and acquiring sources of weed-free and certified weed-free mulch. Sources must be approved by Enbridge prior to purchase and copies of the applicable documentation must be provided to Enbridge.

Mulch will be applied at a rate of 2 tons per acre unless otherwise stipulated by permit conditions. Mulch will be uniformly distributed by a mechanical mulch blower, or by hand in areas not accessible to the mulch blower. Strands of mulch will be a minimum of 8 inches in length to allow proper anchoring. Mulch will be anchored/crimped to a depth of 2 to 3 inches using a mulch-anchoring tool or disc set in the straight position to minimize loss by wind and water. In areas not accessible to a mulch-anchoring tool, the mulch may be anchored by liquid tackifiers, with advance written approval from Enbridge. The manufacturer's recommended method and rate of application will be followed. Mulch will not be applied in wetlands or actively cultivated farmland.

Hydro-mulch and liquid tackifier can be used in place of straw or weed-free hay mulch with prior approval from Enbridge. All hydro-mulch and liquid tackifier products used must be on the applicable state Department of Transportation product list. Application rates will be at the manufacturer's recommended rate, equal to or greater than 2 tons per acre of straw mulch.

### **5.14 EROSION & SEDIMENT CONTROL**

Erosion control blankets, such as sewn straw mats, jute mats, coconut erosion control blankets, or biodegradable synthetic erosion control blankets, as approved by Enbridge, will be used as directed by Enbridge and according to the manufacturer's recommendations as to weight and material for the specific application. Erosion control blankets will be anchored according to the manufacturer's recommendations.

### **5.15 DORMANT SEEDING**

Dormant seeding is conducted after soil temperatures have cooled to 55 degrees Fahrenheit or cooler to prevent seed germination. Dormant seeding is only practicable if the soil is not frozen and

snow is not present. Procedures for applying soil amendments, seedbed preparation, seeding, and mulching are the same as outlined for permanent revegetation in this Revegetation Plan.

Where dormant seeding is conducted, one or more of the following temporary erosion and sediment controls will be put in place over the freshly seeded area unless the local soil conservation authority, landowner, or land managing agency specifies otherwise. The temporary measures will be in place within 48 hours of seeding, and are as follows:

- straw mulch, at not more than 2 tons/acre, anchored;
- hydro-mulch, at 2 tons/acre, anchored; and/or
- erosion control blanket.

Additional erosion control measures will be applied as requested by the EI.

### **5.16 MONITORING**

Enbridge will monitor and address all areas where stabilization techniques have been implemented in accordance with conditions identified in the applicable project permits and/or licenses.

## **6.0 WINTER CONSTRUCTION**

Frozen conditions can preclude effective topsoil segregation. When soil is frozen to a depth greater than the depth of topsoil, the soil will come off in thick slabs that contain both topsoil and subsoil, and mixing can result. If topsoiling must proceed under these conditions, it should be done at the excavation only. A ripper should be used to break up the frozen topsoil. Care should be taken to only rip to the actual depth of topsoil or to a maximum depth of 12 inches, whichever is less. Topsoil in the spoil storage area should be graded smooth to minimize mixing during backfilling. Sufficient time is needed to allow the newly graded topsoil to freeze in place prior to trenching.

The area of open excavation must be minimized during winter construction to reduce amount of frozen backfill, and facilitate restoration to pre-construction contours. If winter conditions preclude final grading and cleanup, the Contractor must stabilize the area and temporary erosion control measures must remain in place until permanent erosion control measures are installed. Depending on site and weather conditions, Enbridge may require the Contractor to install dormant seeding, mulching, and/or installation of erosion control blanket on stream banks or other sensitive locations. The Contractor must monitor areas until final restoration is complete.

Other than those issues discussed above, most environmental requirements can be successfully implemented by the Contractor during winter construction.

## **7.0 WASTE MANAGEMENT**

Proper handling and management of solid and hazardous wastes and materials are an important aspect of every job. The Contractor must properly handle, store, and dispose of all solid and hazardous materials and wastes that are used or generated by the Contractor as a result of the project. The Contractor must determine if the materials and wastes associated with the project classify as hazardous materials and/or wastes in accordance with applicable federal and/or state criteria. Upon request by Enbridge, the Contractor must provide documentation to Enbridge to substantiate findings of the regulatory status of materials and/or wastes used and/or generated as a result of the project.

All waste materials are to be collected daily by the Contractor. Wastes must be collected in suitable or approved containers (i.e., labeled and meeting any relevant regulatory requirements) provided by the Contractor. On a routine basis, the Contractor must remove the containers of waste from the site and properly dispose of them. Throughout the duration of the project, the Contractor must cleanup areas to the satisfaction of Enbridge. The Contractor is responsible for proper off-site disposal of all wastes generated during the project. No wastes are to be left on Enbridge property, along the ROW, or buried in an excavation or otherwise disposed of on Enbridge property or ROW.

Any used oil or other waste liquids generated by the Contractor as a result of maintaining its equipment during the course of the project shall be the responsibility of the Contractor to handle in accordance with all applicable regulations and Enbridge policies. Used oil and all other waste liquids must be stored in approved storage containers in good condition. The containers must be properly labeled. The Contractor is responsible for disposing of waste liquids in accordance with all applicable regulations.

### **7.1 HAZARDOUS WASTES**

It is the responsibility of the Contractor to ensure that all workers are properly trained in the proper storage, handling and disposal of hazardous wastes generated during the project. The Contractor must ensure that wastes classified as hazardous by federal and state regulations are properly labeled and, if liquid, stored on-site with secondary containment and in accordance with all regulatory requirements. Wastes may not be placed, spilled, or poured on or into the ground. If this should occur, the Contractor is responsible for evaluation and cleanup of contaminated soils and associated costs. The Contractor is responsible for immediately reporting the spill to Enbridge. Refer to the Spill Plan for additional details.

If a Contractor generates a hazardous waste from materials they have brought on-site (e.g., paint clean-up solvents, waste paints, etc.), then the Contractor is responsible for proper waste collection, storage and disposal in accordance with all applicable regulations. If a Contractor generates a waste classified as hazardous as a direct result of the constituents coming from an Enbridge facility or equipment (e.g., sandblast debris with lead paint, piping coatings, etc.), then Enbridge will coordinate proper waste collection, storage and disposal with the Contractor. The Contractor remains responsible for the proper handling, storage and disposal of the hazardous waste. Any release of the hazardous waste as a result of the improper handling, storage or disposal by the Contractor in this instance is the responsibility of the Contractor to rectify to the satisfaction of Enbridge and all applicable regulatory agencies.

## **7.2 Concrete washout**

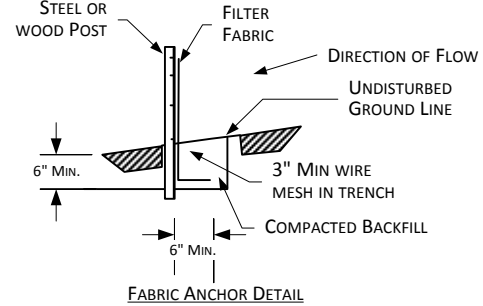
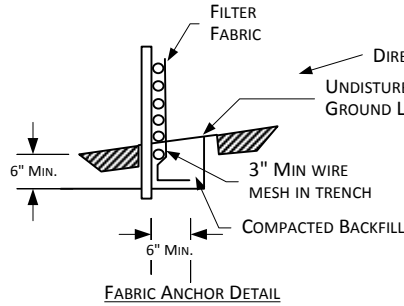
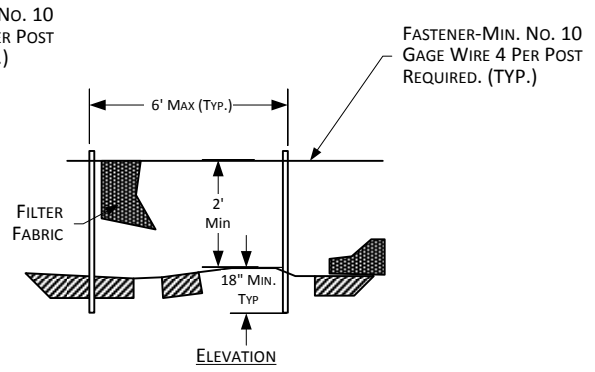
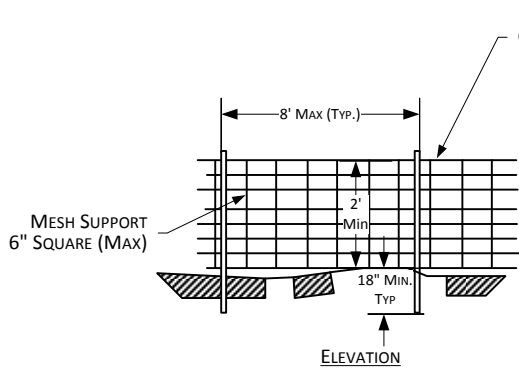
The location of any and all concrete washouts must be approved by Enbridge in advance of construction and cannot be located near storm drains, wetlands, ditches or waterbodies. All liquid and solid wastes generated by concrete washout operations must be contained in a leak-proof containment facility or impermeable liner. A compacted clay liner that does not allow washout liquids to enter ground water is considered an impermeable liner. Concrete washouts must be sized to handle solids, wash water and rainfall. The liquid and solid wastes must not contact the ground, and there must not be runoff from the concrete washout operations or areas. Liquid and solid wastes must be disposed of properly and in compliance with applicable state and/or federal regulations. A sign must be installed adjacent to each washout facility to inform concrete equipment operators to utilize the proper facilities. The Contractor must inspect the concrete washout on a daily basis when in use.

## **7.3 Abrasive Blast Debris**

The Contractor must contain and collect spent abrasive blast materials, to the extent practicable or deemed necessary by Company, and place it into appropriate containers. The Contractor is responsible for covering the containers with appropriate means of rainwater and stormwater control to prevent said waters from entering or exiting the container. The Contractor is responsible for disposal of the spent abrasive in accordance with applicable federal, state and local regulatory requirements. The Contractor is responsible for determining if the spent abrasive is classified as a "hazardous" or "special" waste as defined by applicable federal and state regulations. If the spent abrasive is determined to be hazardous waste as a direct result of constituents of an Enbridge facility or equipment, Enbridge will coordinate proper disposal with the Contractor as previously discussed.

## Figures



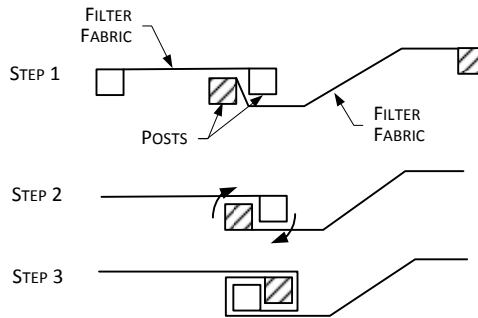


SILT FENCE WITH WIRE SUPPORT PLAN

SILT FENCE PLAN  
NTS

**NOTES:**

1. WIRES OF MESH SUPPORT SHALL BE MIN. GAGE NO. 12.
2. FILTER FABRIC SHALL MEET THE REQUIREMENTS OF THE SPECIFICATION WITH EQUIVALENT OPENING SIZE OF AT LEAST 30 FOR NONWOVEN AND 50 FOR WOVEN. (SIEVE NO.)
3. THE POSTS USED TO SUPPORT THE SILT FENCE SHOULD BE HARDWOOD MATERIAL WITH A MINIMUM CROSS SECTIONAL AREA OF 4 INCHES SQUARE AND 4 FEET LONG. METAL POSTS SHOULD BE USED IN AREAS THAT POND WATER.



ATTACHING TWO SILT FENCES

**NOTES:**

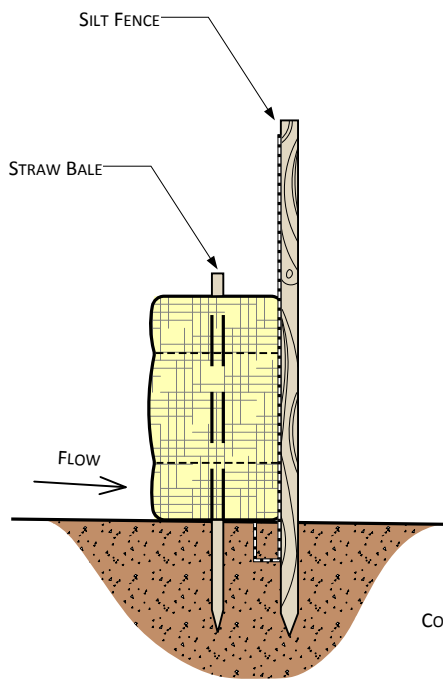
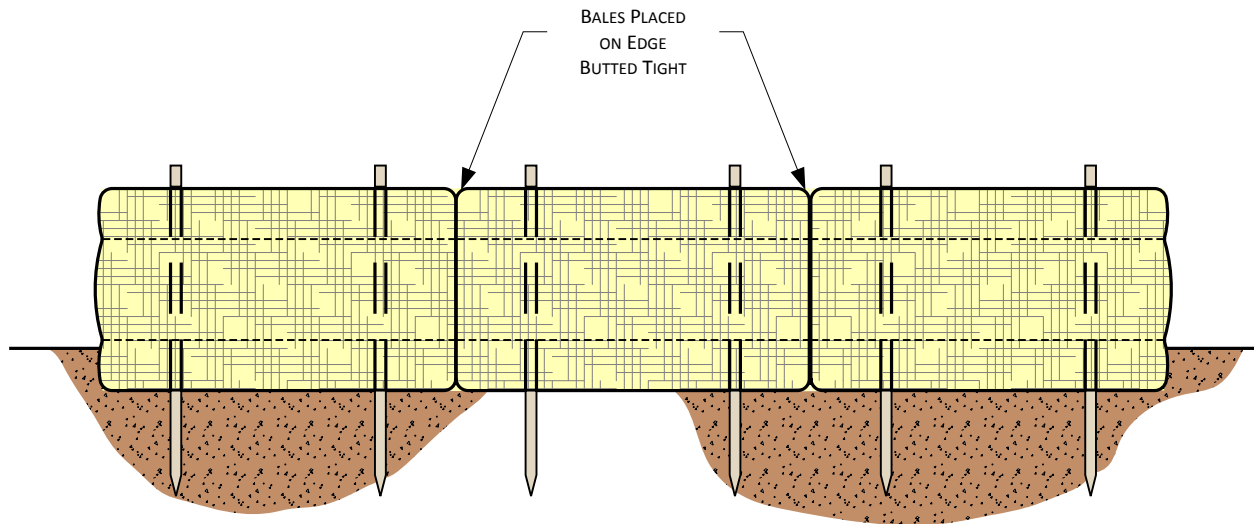
1. PLACE THE END POST OF THE SECOND FENCE INSIDE THE END POST OF THE FIRST FENCE.
2. ROTATE BOTH POSTS AT LEAST 180 DEGREES IN A CLOCKWISE DIRECTION TO CREATE A TIGHT SEAL WITH THE FABRIC MATERIAL.
3. DRIVE BOTH POSTS A MINIMUM OF 18 INCHES IN THE GROUND AND BURY THE FLAP.

For environmental review purposes only.

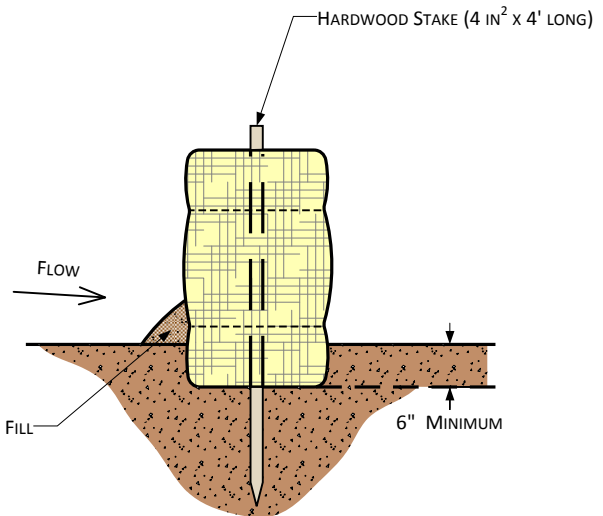


**Figure 1**  
**Line 67 Enhancement Project**  
**Typical Silt Fence Installation**

DATE: 5/25/2001	
REVISED: 8/30/2012	
SCALE: NTS	
DRAWN BY: KMKENDALL	
K:\CLIENT_PROJECTS\SD-FEEL\2011-019\FIG_6_SILT_FENCE_INSTALL.VSD	



STRAW BALES & SILT FENCE



STRAW BALES ONLY

For environmental review purposes only.



**Figure2**  
**Line 67 Enhancement Project**  
 Typical Straw Bale Installation

DATE: 5/25/01

REVISED: 8/30/12

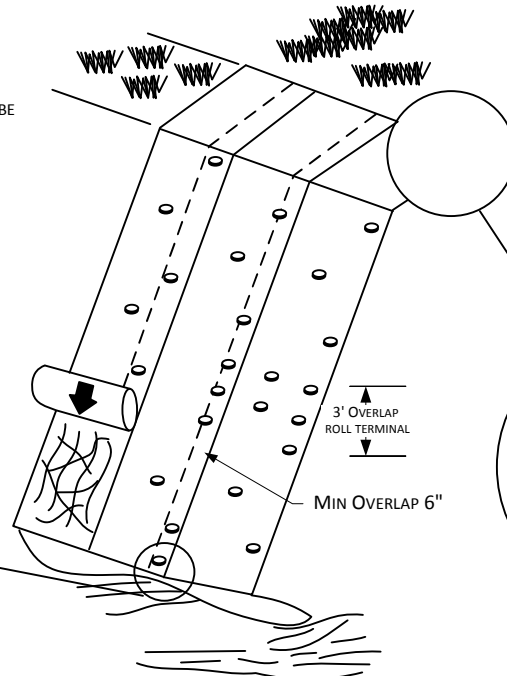
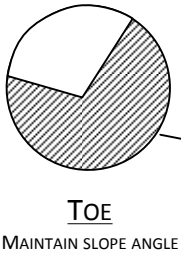
SCALE: Not to Scale

DRAWN BY: KMKENDALL

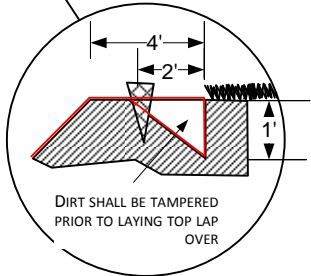
K:\CLIENT PROJECTS\ID-FEEL\2011-019\FIG\_7\_STRAW\_BALE\_INSTALL.VSD



**FILL SLOPE SECTION**  
 EROSION CONTROL BLANKETS SHOULD BE  
 INSTALLED VERTICALLY DOWNSLOPE.

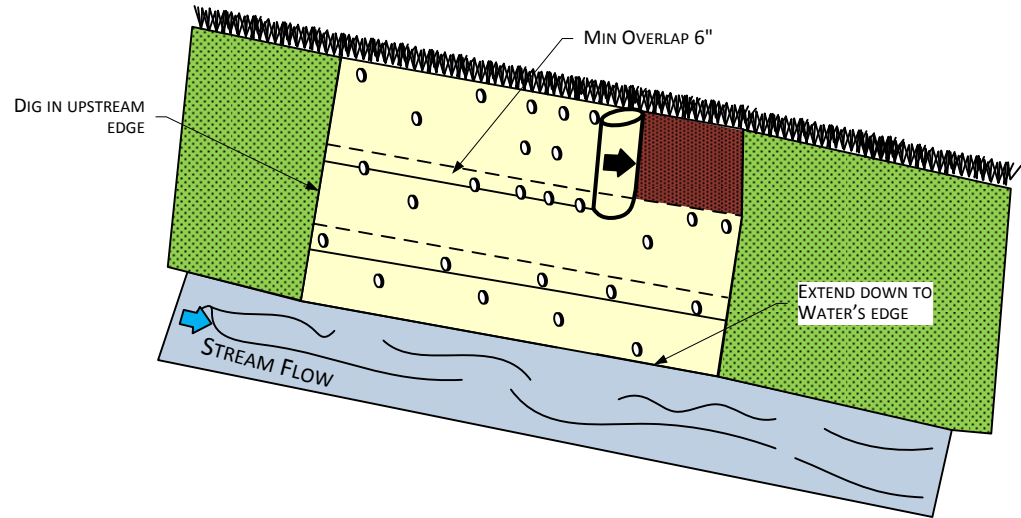


NOTE: SLOPE SURFACE SHALL BE  
 SMOOTH AND FREE OF ROCKS,  
 LUMPS OF DIRT, GRASS AND STICKS.  
 MAT SHALL BE PLACED FLAT ON SURFACE  
 TO ENSURE PROPER SOIL CONTACT.



**BERM**  
 TRENCH INTO BERM AND  
 PROGRESS DOWNSLOPE

**STREAM CHANNEL**  
 EROSION CONTROL BLANKETS SHOULD BE  
 HORIZONTALLY WITH STREAM FLOW.



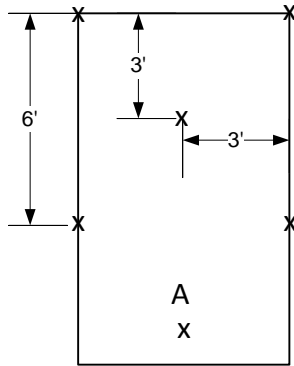
For environmental review purposes only.



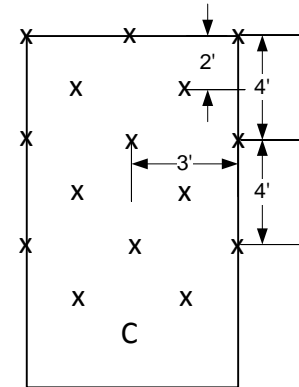
**Figure 3**  
**Line 67 Enhancement Project**  
 Typical Erosion Control Blanket Installation

DATE: 5/25/2001  
 REVISED: 8/30/2012  
 SCALE: NTS  
 DRAWN BY: KMKENDALL  
 K:\CLIENT\_PROJECTS\SD-FEEL\2011-019\FIG 8 EROSION\_CONTROL\_BLANKET\_INS TALL.VSD

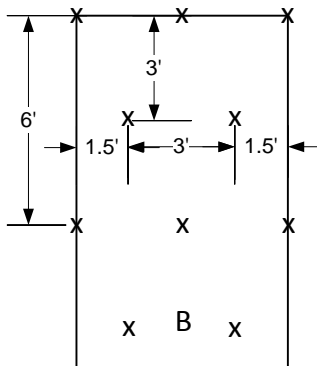
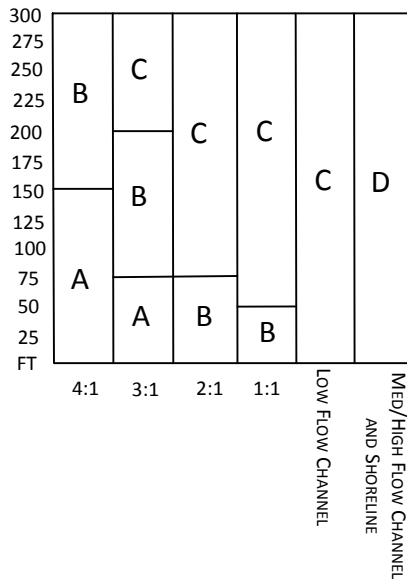




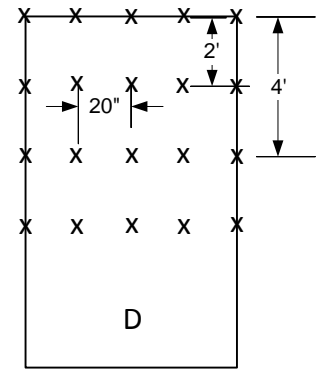
1 STAPLE PER SQ. YD



2 STAPLES PER SQ. YD



1 1/2 STAPLES PER SQ. YD



3 1/2 STAPLES PER SQ. YD

FOR OPTIMUM RESULTS, THESE RECOMMENDED STAPLE PATTERN GUIDES MUST BE FOLLOWED. SUGGESTED ANCHORING METHODS VARY ACCORDING TO THE MANUFACTURER. THIS CHART SHOWS HOW TO SLOPE LENGTHS AND HOW GRADIENTS AFFECT SAMPLING PATTERNS.

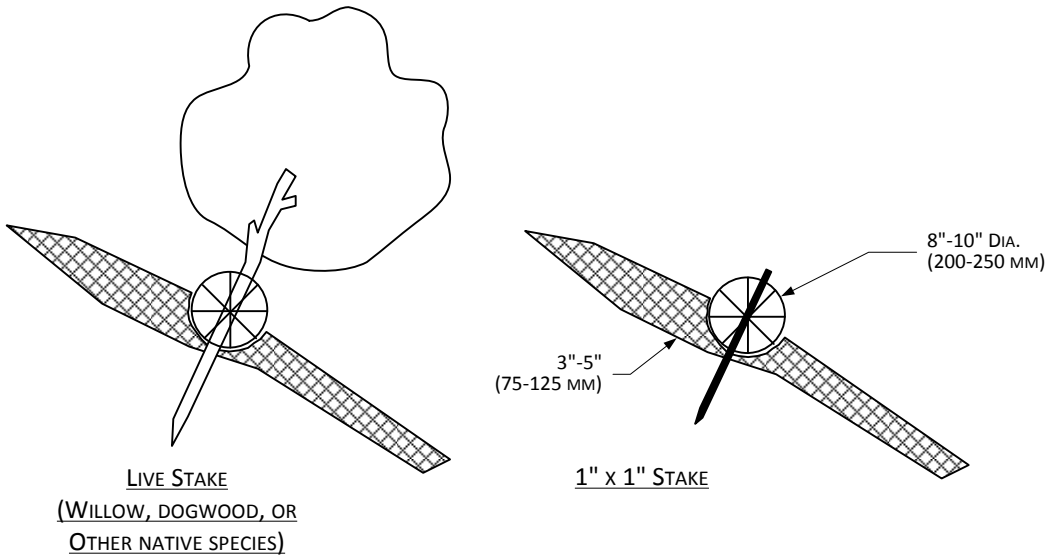
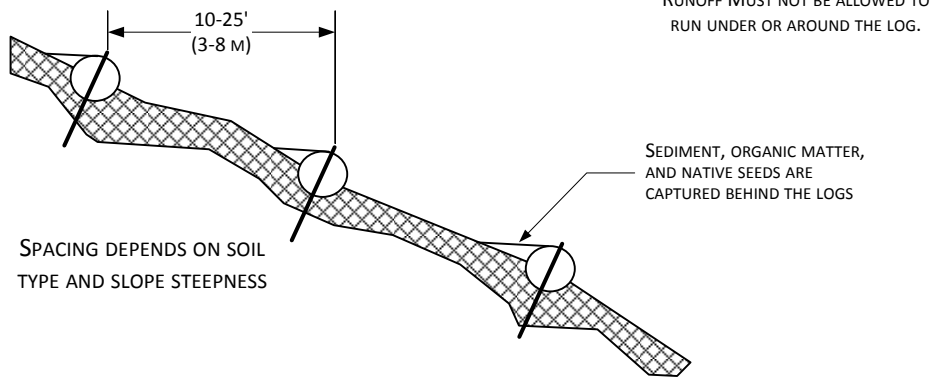
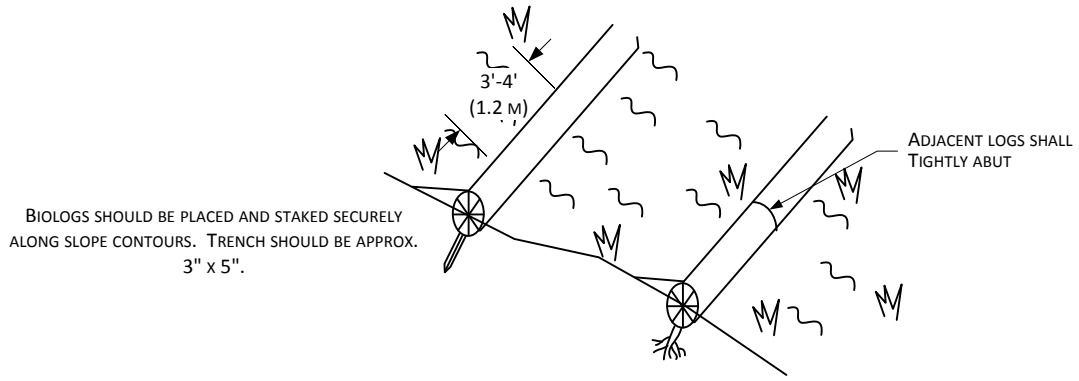
For environmental review purposes only.



**Figure 4**  
Line 67 Enhancement Project  
Typical Staple Pattern for  
Erosion Control Fabric

DATE: 5/25/2001  
REVISED: 8/30/2012  
SCALE: NTS  
DRAWN BY: KMKENDALL  
K:\CLIENT\_PROJECTS\D-FEEL\2011-019\FIG\_9\_STAPLE\_PATTERN\_EROSION\_CON TROL\_FABRIC.VSD



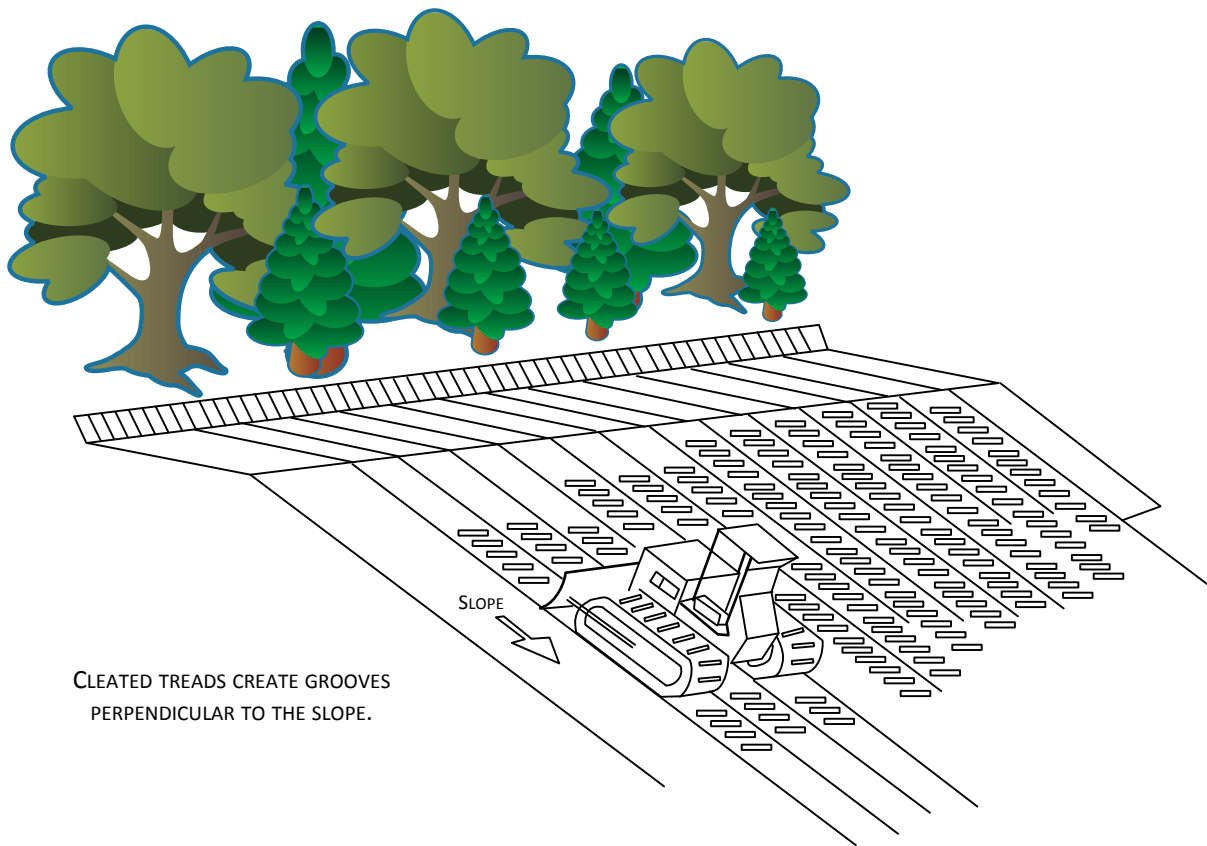


For environmental review purposes only.



**Figure 5**  
Line 67 Enhancement Project  
Typical Biolog Installation

DATE: 5/25/2001	
REVISED: 8/30/2012	
SCALE: NTS	
DRAWN BY: KMKENDALL	
<small>K:\_CLIENT_PROJECTS\D-FEEL\2011-019\FIG_10_BIOLOG_INSTALL.VSD</small>	



CLEATED TREADS CREATE GROOVES  
PERPENDICULAR TO THE SLOPE.

For environmental review purposes only.



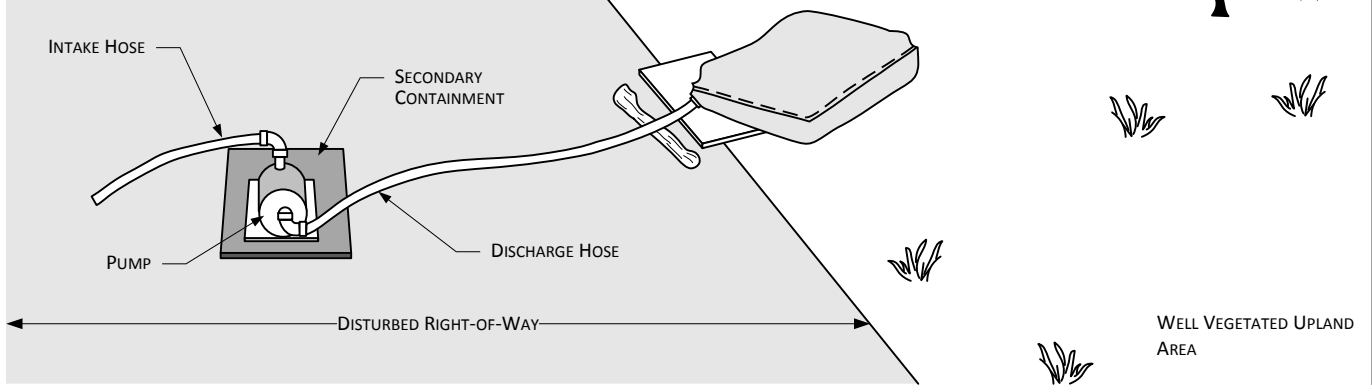
**Figure 6**  
**Line 67 Enhancement Project**  
Typical Cat Tracking

DATE: 5/25/2001	
REVISED: 8/30/2012	
SCALE: NTS	
DRAWN BY: KMKENDALL	
<small>K:\_CLIENT_PROJECTS\D-FEEL\2011-019\FIG_11_CAT_TRACKING.VSD</small>	

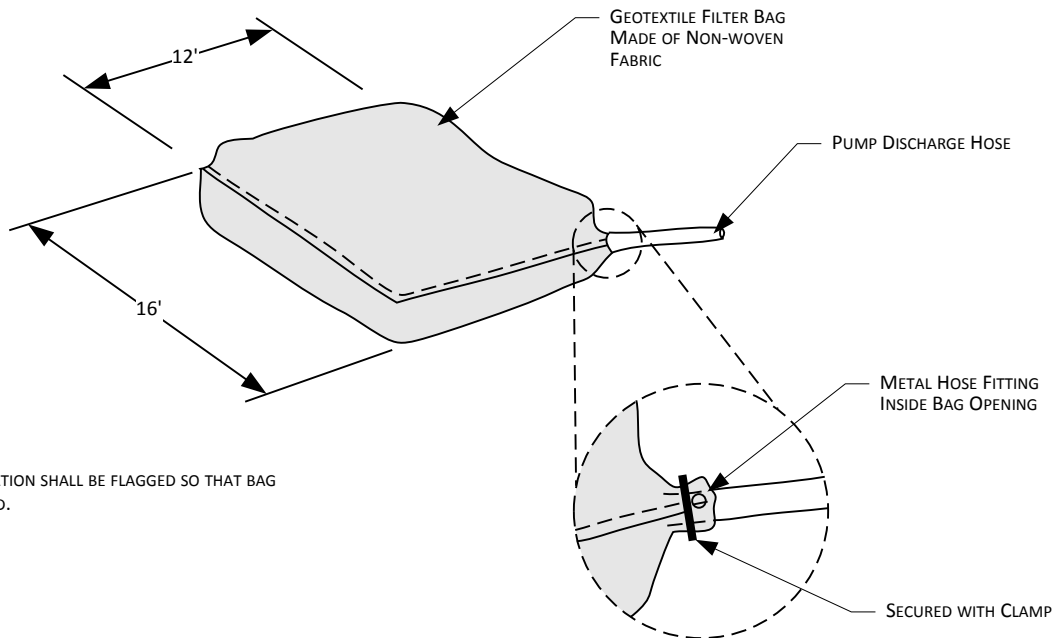
## DEWATERING DISCHARGE IN WELL VEGETATED UPLANDS

**NOTES:**

1. PUMP INTAKE HOSE MUST BE SECURED AT LEAST ONE FOOT ABOVE THE TRENCH BOTTOM.
2. DEWATER INTO GEOTEXTILE FILTER BAG OR STRAW BALE DEWATERING STRUCTURE.



## GEOTEXTILE FILTER BAG



**NOTE:**

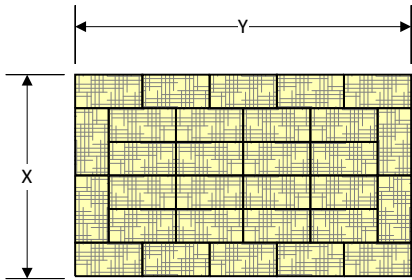
1. FILTER BAG LOCATION SHALL BE FLAGGED SO THAT BAG CAN BE REMOVED.

For environmental review purposes only.



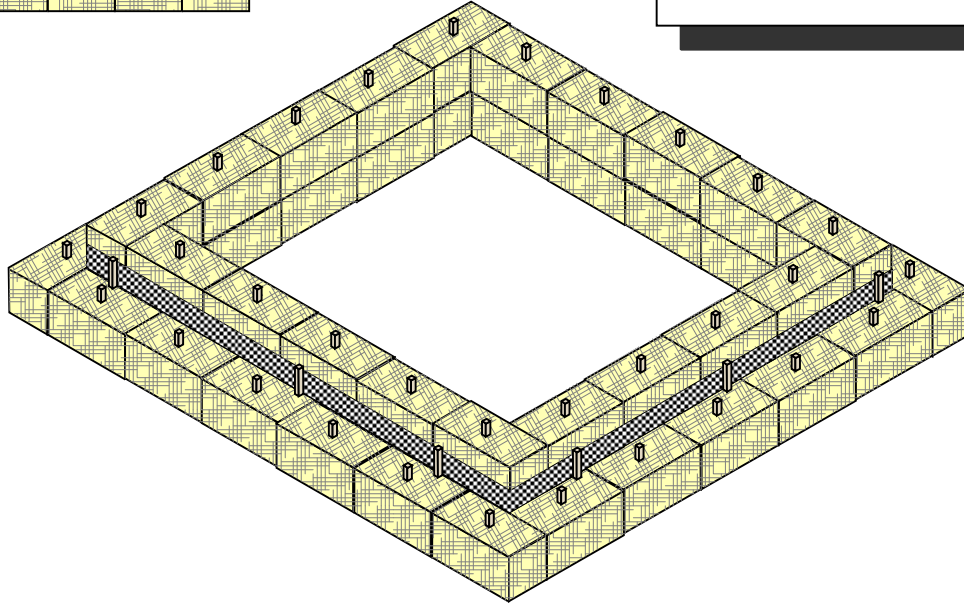
**Figure 7**  
Line 67 Enhancement Project  
Typical Dewatering Measures

DATE: 5/25/2001	NATURAL RESOURCE GROUP
REVISED: 8/30/2012	
SCALE: NTS	
DRAWN BY: KMKENDALL	
K:\CLIENT_PROJECTS\SD-FEEL\2011-019\FIG_21_DEWATERING_MEASURES.VSD	

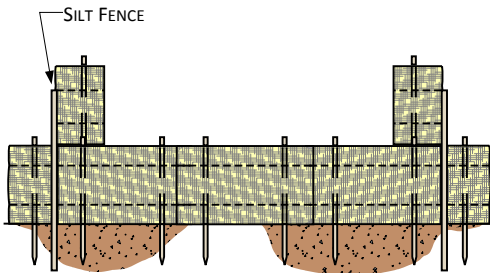


**NOTES**

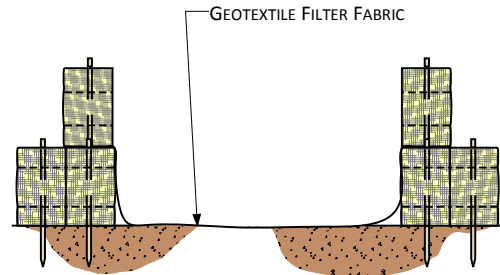
1. ARRANGE THE STRAW BALES TO THE X AND Y DIMENSIONS AS SPECIFIED BELOW.
2. IF BOTTOM OF STRUCTURE IS NOT LINED WITH STRAW BALES (OPTION 1), LINE ENTIRE STRUCTURE WITH GEOTEXTILE FILTER FABRIC.



PERSPECTIVE VIEW



OPTION 1



OPTION 2

MINIMUM SUMP DIMENSIONS (FEET)		MAXIMUM PUMPING RATE GALLONS PER MINUTE
X	Y	
10	20	300
15	20	350
20	20	400
20	25	450
25	25	500
25	30	550
30	30	660

For environmental review purposes only.

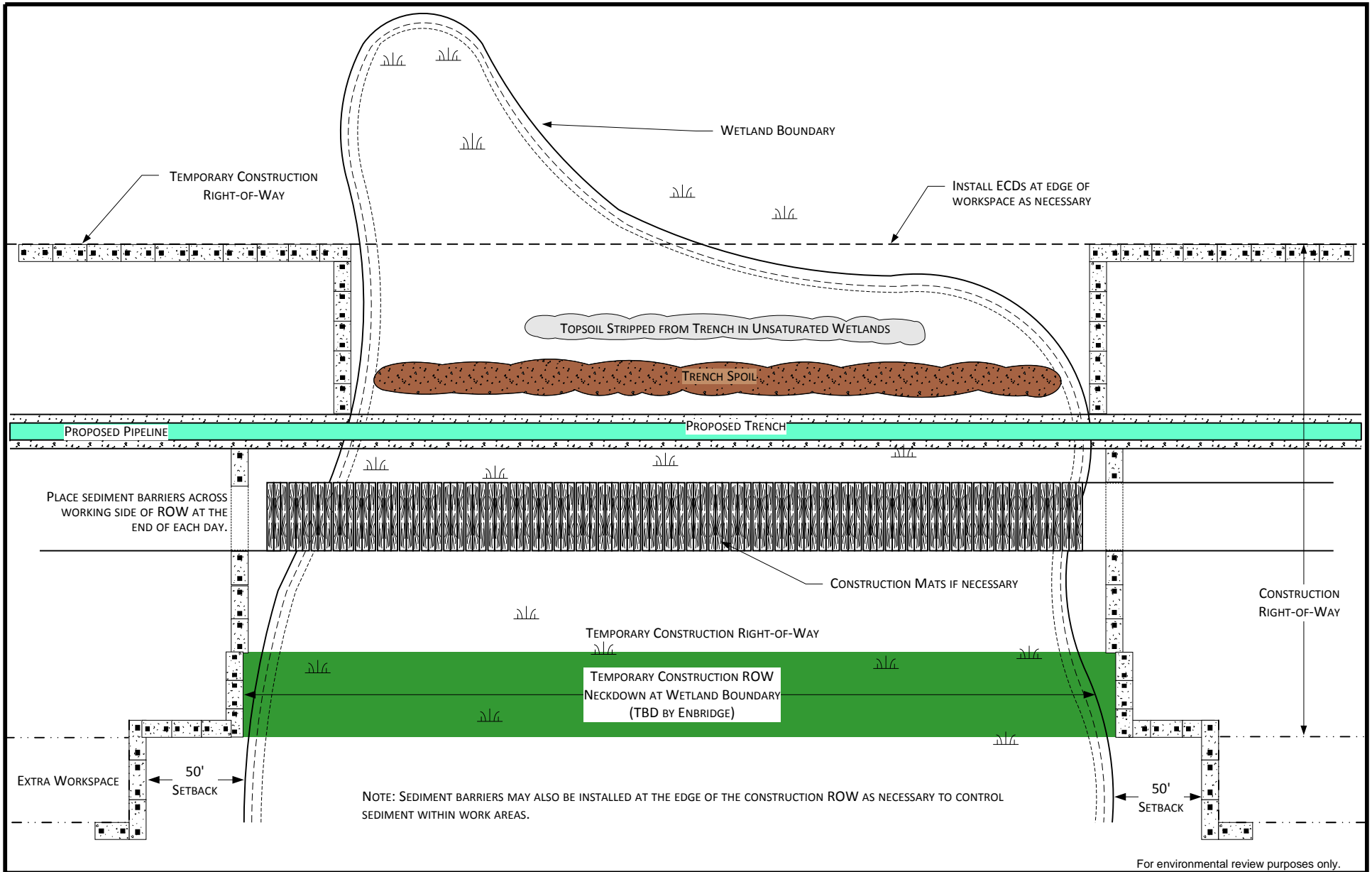


**Figure 8**  
**Line 67 Enhancement Project**  
**Typical Straw-Bale Dewatering Structure**

DATE: 5/25/2001  
 REVISED: 8/30/2012  
 SCALE: NTS  
 DRAWN BY: KMKENDALL  
 K:\CLIENT\_PROJECTS\SD-FEEL\2011-019\FIG 22\_STRAW\_BALE\_DEWATERING\_STRUCTURE\_A.VSD







For environmental review purposes only.



**Figure 9**  
**Line 67 Enhancement Project**  
**Typical Wetland Crossing Method**

DATE: 5/25/2001	
REVISED: 8/30/2012	
SCALE: NTS	
DRAWN BY: KMKENDALL	
<small>K:\_CLIENT PROJECTS\SD-FIEEL\2011-019\FIG_24_WETLAND_CROSSING_METHOD.VSD</small>	

## **Appendix A**

### **Seed Mixes**

**Table 1 – Temporary Cover Crop Seed Mix**

<b>Seed Name</b>	<b>Pure Live Seed (Pounds Per Acre)</b>	<b>% of Seed</b>
Oats if summer seeding ( <i>Avena sativa</i> ) or Winter Wheat if dormant (late fall) or spring seeding ( <i>Triticum aestivum</i> )	40	50%
Annual Ryegrass ( <i>Lolium italicum</i> ), Annual Alfalfa ( <i>Medicago sativa</i> ), or Slender Wheat Grass ( <i>Elymus trachycaulus</i> )	40	50%
<b>TOTAL</b>	<b>80</b>	<b>100%</b>

**Table 2 – Construction Area Standard Upland Seed Mix**

<b>Seed Name</b>	<b>Pure Live Seed (Pounds Per Acre)</b>	<b>% of Seed</b>
Perennial Ryegrass ( <i>Lolium perenne</i> )	2	17%
Canada Wild-rye ( <i>Elymus canadensis</i> )	4	33%
Switchgrass ( <i>Panicum virgatum</i> ) (unimproved native variety)	4	33%
Timothy ( <i>Phleum pratense</i> )	2	17%
<i>Total</i>	12 pounds	100%
<b>Associated Companion Crop Mix</b>		
Oats if summer seeding ( <i>Avena sativa</i> ) or Winter Wheat if late fall (dormant) or spring seeding ( <i>Triticum aestivum</i> )	16	80%
Annual Ryegrass ( <i>Lolium italicum</i> ), or Slender Wheat Grass ( <i>Elymus trachycaulus</i> )	4	20%
<i>Companion/Cover Crop Total</i>	20	100%
<b>GRAND TOTAL</b>	32 pounds	100%

**Table 3- Unsaturated Wetland Seed Mix – General Restoration Mix**

<b>Seed Name</b>	<b>Pure Live Seed (Pounds Per Acre)</b>	<b>Percent (%) of Seed</b>
Virginia Wild Rye <i>(Elymus virginicus)</i>	6	30%
Annual Rye Grass <i>(Lolium perene)</i>	8	40%
Fowl Bluegrass <i>(Poa palustris)</i>	6	30%
<i>Total</i>	20.0 pounds	100%