

Appendix A
Environmental Protection Plan



**Enbridge Pipelines (North Dakota) LLC
Sandpiper Environmental Services
Sandpiper Pipeline Project**

ENVIRONMENTAL PROTECTION PLAN

October 2013





ENVIRONMENTAL PROTECTION PLAN

TABLE OF CONTENTS

INTRODUCTION	1
1.0 GENERAL MITIGATION MEASURES.....	3
1.1 IDENTIFICATION OF AVOIDANCE AREAS.....	3
1.2 CONSTRUCTION LINE LIST AND PERMITS.....	3
1.3 WET WEATHER SHUTDOWN	3
1.4 RIGHT-OF-WAY ACCESS.....	3
1.5 RIGHT-OF-WAY REQUIREMENTS.....	4
1.6 CONTROLLING SPREAD OF UNDESIRABLE SPECIES	4
1.6.1 Prevention and Control Measures	5
1.7 POTHOLING/HYDROVAC SLURRY	6
1.8 UPLAND CLEARING	6
1.8.1 Disposal of Non-Merchantable Timber	6
1.8.2 Disposal of Merchantable Timber.....	6
1.8.3 Upland Grading and Stump Removal.....	6
1.9 TEMPORARY EROSION AND SEDIMENT CONTROLS.....	7
1.9.1 Temporary Stabilization.....	7
1.9.2 Erosion Control Blanket.....	7
1.9.3 Mulch	8
1.9.4 Cat Tracking.....	8
1.9.5 Temporary Slope Breakers.....	8
1.10 UPLAND TOPSOIL SEGREGATION.....	9
1.11 UPLAND TRENCHING	10
1.11.1 Timing	10
1.12 FOAM PILLOW INSTALLATION.....	10
1.13 TRENCH BREAKERS	10
1.14 DRAIN TILE INLET PROTECTION AND TILE REPAIRS.....	11
1.15 UPLAND BACKFILLING	11
1.16 CLEANUP AND ROUGH/FINAL GRADING.....	11
1.16.1 Timing	12
1.17 PERMANENT EROSION AND SEDIMENT CONTROLS.....	12
1.18 SOIL COMPACTION TREATMENT	12

1.19	STONE REMOVAL.....	12
1.20	REPAIR OF DAMAGED CONSERVATION PRACTICES.....	13
1.21	LAND LEVELING FOLLOWING CONSTRUCTION.....	13
2.0	STREAM AND RIVER CROSSING GENERAL REQUIREMENTS.....	14
2.1	TIME WINDOW FOR CONSTRUCTION.....	14
2.2	CLEARING AND GRADING.....	14
2.2.1	Impaired Waters.....	15
2.3	ADDITIONAL TEMPORARY WORKSPACE.....	15
2.4	BRIDGES.....	15
2.4.1	Types of Bridges.....	15
2.4.2	Bridge Design and Maintenance.....	16
2.5	STREAM AND RIVER CROSSING CONSTRUCTION METHODS.....	16
2.5.1	Wet Trench Method.....	17
2.5.2	Dam and Pump Method.....	18
2.5.3	Flume Method.....	19
2.5.4	Directional Drill and/or Guided Bore Method.....	20
2.6	PERMANENT RESTORATION.....	21
2.6.1	Vegetative Bank Restoration.....	21
2.6.2	Supplemental Bank Stabilization.....	21
2.6.3	Bridge Removal.....	21
2.6.4	Swales.....	22
3.0	WETLAND CROSSING GENERAL REQUIREMENTS.....	23
3.1	WETLAND ACCESS.....	23
3.2	CLEARING.....	23
3.3	ADDITIONAL TEMPORARY WORKSPACE IN WETLANDS.....	23
3.4	GRADING IN A WETLAND.....	24
3.5	RIGHT-OF-WAY STABILIZATION.....	24
3.6	TRENCHING.....	24
3.6.1	Topsoil Segregation.....	24
3.6.2	Trench Breakers.....	25
3.7	PIPELINE INSTALLATION.....	25
3.7.1	Push/Pull Method.....	25
3.7.2	Temporary Erosion and Sediment Controls.....	25
3.7.3	Concrete Coating.....	25
3.8	BACKFILLING.....	25
3.9	ROUGH GRADING, CLEANUP, AND TEMPORARY RESTORATION.....	26
3.9.1	Timing.....	26
3.9.2	Temporary Stabilization.....	26
4.0	HIGHWAY, ROAD and RAIL CROSSINGS.....	27
4.1	ADDITIONAL WORKSPACE.....	27
4.2	MAINTENANCE.....	27

4.3	TEMPORARY EROSION AND SEDIMENT CONTROLS.....	27
5.0	CONSTRUCTION DEWATERING.....	28
5.1	TRENCH DEWATERING.....	28
5.1.1	Flow Measurement and Water Sampling.....	29
5.1.2	Regulatory Notification and Reporting.....	29
5.2	HYDROSTATIC TEST DISCHARGES.....	29
5.2.1	Refueling.....	29
5.2.2	Siting of Test Manifolds.....	29
5.2.3	Water Sampling.....	29
5.2.4	Best Management Practices.....	29
5.2.5	Flow Measurement.....	30
6.0	WATER APPROPRIATION.....	31
6.1	GENERAL.....	31
6.2	WATER SOURCES.....	31
6.3	FLOW MEASUREMENT.....	31
6.4	WATER SAMPLING.....	31
6.5	REGULATORY NOTIFICATION AND REPORTING.....	31
7.0	REVEGETATION & MONITORING.....	32
7.1	PROJECT SEED SPECIFICATIONS.....	32
7.2	TEMPORARY REVEGETATION.....	32
7.3	TIMING FOR TEMPORARY VEGETATION.....	33
7.4	MULCH.....	33
7.5	PERMANENT REVEGETATION.....	33
7.6	UPLAND CONSTRUCTION AREAS.....	34
7.7	PERMANENT SEEDING OF WETLAND AREAS.....	34
7.7.1	Unsaturated Wetland Areas.....	34
7.7.2	Saturated/Standing Water Wetlands.....	34
7.7.3	Forested Wetland Restoration.....	34
7.8	PERMANENT SEEDING OF WATERBODY BANKS.....	34
7.9	SPECIALIZED SEED MIXES.....	34
7.10	CONSERVATION RESERVE PROGRAM (CRP) PROPERTIES.....	35
7.11	SEED BED PREPARATION AND SEEDING PROCEDURES.....	35
7.12	SEEDING METHODS.....	35
7.12.1	Drill Seeding.....	35
7.12.2	Broadcast Seeding.....	35
7.12.3	Hydroseeding.....	36
7.13	SOIL AMENDMENTS.....	36
7.14	SEEDING PERIODS.....	36
7.15	TIMING OF FINAL SEEDING.....	36

7.16	EROSION & SEDIMENT CONTROL	36
7.17	DORMANT SEEDING.....	37
7.18	MONITORING	37
8.0	WINTER CONSTRUCTION.....	38
9.0	WASTE MANAGEMENT	39
9.1	HAZARDOUS WASTES	39
9.2	ABRASIVE BLAST DEBRIS	39
10.0	SPILL PREVENTION, CONTAINMENT, AND CONTROL MEASURES	40
10.1	PLANNING AND PREVENTION	40
10.2	ROLES AND RESPONSIBILITIES.....	40
	10.2.1 Spill Coordinator.....	40
	10.2.2 Environmental Inspector.....	40
	10.2.3 Authorized Personnel	41
	10.2.4 Construction Superintendent	41
	10.2.5 Construction Personnel	41
10.3	TRAINING.....	41
10.4	EQUIPMENT	41
10.5	SUPERVISION AND INSPECTION	42
10.6	STORAGE AND HANDLING OF FUELS/HAZARDOUS LIQUIDS	42
	10.6.1 Fuel Storage - General	42
	10.6.2 Refueling.....	42
	10.6.3 Refueling, Maintenance, and Fuel Storage Near Wetlands and Waterbodies.....	42
	10.6.4 Overnight parking.....	43
	10.6.5 Concrete Washout Handling.....	43
10.7	INITIAL SPILL MANAGEMENT.....	43
	10.7.1 Immediate Response.....	43
	10.7.2 Mobilization	44
10.8	SPILL NOTIFICATION RESPONSIBILITIES.....	44
	10.8.1 Notification Volumes.....	44
	10.8.2 Spill Report Form	44
	10.8.3 Agency Notification.....	44
10.9	SPILL CONTAINMENT AND CLEANUP	45
	10.9.1 Spill Control - Upland Areas	45
10.10	SPILL CONTROL - WETLANDS AND WATERBODIES	45
10.11	STORAGE AND DISPOSAL OF CONTAMINATED MATERIALS	46
11.0	DRILLING FLUID RESPONSE, CONTAINMENT, & NOTIFICATION PROCEDURES ..	47
11.1	ON-SITE OBSERVATION DURING CONSTRUCTION	47
11.2	CONTAINMENT, RESPONSE, AND CLEAN-UP EQUIPMENT	47
11.3	RESPONSE.....	48
	11.3.1 Upland Locations.....	48

11.3.2 Wetland and Waterbody Locations48

11.4 NOTIFICATION AND RESUMPTION OF SUSPENDED HDD OPERATIONS ...49

11.5 CLEAN-UP.....49

11.6 RESTORATION AND POST-CONSTRUCTION MONITORING50

FIGURES¹

Figure 1	Typical Topsoil Segregation – Modified Ditch Plus Spoil Side
Figure 2	Typical Topsoil Segregation – Full Right-of-Way
Figure 3	Typical Topsoil Segregation – Trench Line Only
Figure 4	Typical Temporary or Permanent Berms – Perspective View
Figure 5	Typical Temporary or Permanent Berms – Elevation View
Figure 6	Typical Silt Fence Installation
Figure 7	Typical Straw Bale Installation
Figure 8	Typical Erosion Control Blanket Installation
Figure 9	Typical Staple Pattern for Erosion Control Fabric
Figure 10	Typical Bio-log Installation
Figure 11	Typical Cat Tracking
Figure 12	Typical Trench Breakers – Perspective View
Figure 13	Typical Trench Breakers – Plan and Profile Views
Figure 14	Permanent Slope Breakers – Perspective View
Figure 15	Typical Waterbody Crossing – Wet Trench Method
Figure 16	Typical Waterbody Crossing – Dam and Pump Method
Figure 17	Typical Waterbody Crossing – Flume Method
Figure 18	Typical Waterbody Crossing – Directional Drill Method
Figure 19	Typical Span Type Bridge With and Without Support (Timber Mat Bridge)
Figure 20	Typical Rock and Flume Bridge
Figure 21	Typical Dewatering Measures
Figure 22A	Typical Straw Bale Dewatering Structure
Figure 22B	Typical Straw Bale Dewatering Structure
Figure 22C	Typical Straw Bale Dewatering Structure
Figure 23	Typical Final Stream Bank Stabilization – Rip Rap & Erosion Control
Figure 24	Typical Wetland Crossing
Figure 25	Typical Improved Road Crossing-Directional Bore
Figure 26	Typical Stream Bank Stabilization Bio-log
Figure 27	Typical Root Wad
Figure 28	Typical Natural Material Revetment

APPENDICES

Appendix A	Noxious and Invasive Weed Species
Appendix B	Equipment Cleaning Log
Appendix C	Seed Mixes
Appendix D	EPND Environment Hydrostatic Test Discharge Authorization & Documentation
Appendix E	Emergency Response Contractors/Disposal and Treatment Facilities
Appendix F	Spill Report Form
Appendix G	Spill Reporting-Agency Contacts

¹ Site-specific plans supersede any design presented in the typical details.

INTRODUCTION

This Environmental Protection Plan (EPP) outlines construction-related environmental policies, procedures, and protection measures developed by EPND Pipelines (North Dakota) LLC (EPND) as a baseline for construction of the Sandpiper Pipeline Project (Sandpiper or Project). This EPP was developed based on EPND's experience implementing Best Management Practices (BMPs) during construction as well as the Federal Energy Regulatory Commission's (FERC's) Upland Erosion Control, Revegetation, and Maintenance Plan (May 2013 Version) and Wetland and Waterbody Construction and Mitigation Procedures (May 2013 Version). It is intended to meet or exceed federal, state, tribal, and local environmental protection and erosion control requirements, specifications and practices. The EPP is designed to address typical circumstances that may be encountered along the Project. Project-specific permit conditions and/or landowner agreements may supersede general practices described in this document.

This document includes the following sections:

- Section 1.0 describes general mitigation measures, including soil erosion and sedimentation control procedures, to be implemented during upland construction and upland restoration;
- Section 2.0 describes stream and river construction, crossing, and restoration;
- Section 3.0 describes practices for wetland construction, crossings, and restoration;
- Section 4.0 describes highway, road, and rail crossings;
- Section 5.0 describes construction dewatering;
- Section 6.0 outlines water appropriation practices;
- Section 7.0 addresses revegetation measures;
- Section 8.0 addresses winter construction issues;
- Section 9.0 addresses waste management issues;
- Section 10.0 addresses construction equipment-related spill prevention, containment and controls; and
- Section 11.0 addresses containment, response, and notification procedures for inadvertent releases of drilling fluid.

Alternative construction procedures implemented in lieu of this EPP will provide an equal or greater level of protection to the environment, and will be approved in writing by EPND. Modifications for the construction of dual pipelines are highlighted below in the appropriate sections.

Unless otherwise specified, the construction Contractor (Contractor) is responsible for implementing the requirements of this EPP.

EPND will provide appropriate construction oversight to confirm and document compliance with the measures of this EPP and requirements of applicable federal, state, tribal, and local permits. EPND's Environmental Inspectors (EIs) will assist the Contractor in interpreting and implementing the requirements of the EPP, and verify compliance with these procedures for

EPND. EPND will employ experienced EIs to manage unforeseen situations that are not directly addressed by the Project documents. EPND relies on the experience and judgment of the EIs, through coordination and consultations with Project management staff, to address unforeseen situations should they occur in the field. The EIs will be expected to use judgment in the field to interpret environmental conditions and requirements, but will not be authorized to make major modifications or changes without the prior written approval of EPND. The EI, in consultation with EPND Environment staff, will have the authority to stop activities and order corrective mitigation for actions that are not in compliance with the measures in this EPP, landowner agreements, or environmental permit requirements. The EI will maintain appropriate records to document compliance with these and other applicable environmental permit conditions.

1.0 GENERAL MITIGATION MEASURES

1.1 IDENTIFICATION OF AVOIDANCE AREAS

The EI will post signs for environmental features such as wetlands, waterbodies, drainages/drain tiles, buffer zones, rare plant or ecological community sites, invasive species and noxious weed locations, regulated wildlife habitat, cultural resources, and erosion-prone or steep slopes.

1.2 CONSTRUCTION LINE LIST AND PERMITS

EPND will provide the Contractor with a Construction Line List (CLL) that describes special requirements (e.g., timber salvage, topsoil segregation, restoration measures, fencing requirements, etc.) as agreed upon with landowners provided the conditions conform to the Project permits. The Contractor will comply with these special requirements and/or permit conditions.

The CLL identifies requirements and comments provided by Landowners; however it is not a comprehensive list of construction requirements. The CLL will be considered in conjunction with other Project documents and permits.

1.3 WET WEATHER SHUTDOWN

During construction, certain activities may be suspended in wet soil conditions, based on consideration of the following factors:

- extent of surface ponding;
- extent and depth of rutting and mixing of soil horizons;
- areal extent and location of potential rutting and compaction (i.e., can traffic be rerouted around wet area); and
- type of equipment and nature of the construction operations proposed for that day.

The Contractor will cease work in the applicable area until EPND determines that site conditions are such that work may continue. The EIs, in collaboration with EPND construction management, will ultimately decide if wet weather shutdown is necessary in a given location.

1.4 RIGHT-OF-WAY ACCESS

Access to the right-of-way (ROW) will be from public roadways and EPND-approved private access roads only. EPND is responsible for posting signs or other methods to identify approved access roads in the field and to ensure that access is confined to only the approved roads. Vehicle tracking of soil from the construction site will be minimized by installation and implementation of best management practices (BMPs) such as stone pads, timber mats, reducing equipment/vehicle access to the construction ROW where practicable (off-ROW parking), or equivalent. Installation of stone or timber mat access pads will be in accordance with applicable permits and state/federal specifications. If such BMPs are not adequately preventing sediment from being tracked onto public roads, street sweeping, or other equivalent means of collecting sediment, will be used. If soil is tracked onto a roadway, the contractor will remove accumulated material from the road and returned to the construction ROW within an upland area as soon as possible, but in no circumstances more than 24 hours after discovery.

In addition, soil on roadways cannot be broomed, washed, and/or graded into the road ditch or onto the shoulder.

1.5 RIGHT-OF-WAY REQUIREMENTS

All construction equipment and vehicles will be confined to the approved construction ROW and additional temporary workspace. Prior to commencement of clearing operations, the outer limits of the construction ROW and additional temporary workspace areas will be marked with distinctive stakes and flagging by EPND. Construction activities are restricted to the approved designated areas.

The construction ROW (i.e., construction workspace) for the Project will vary and may include a portion of EPND's existing corridor, new permanent corridor, permitted temporary workspace, and site-specific extra workspaces as defined below and shown in Figures 1 through 3. The construction ROW width will be reduced in selected locations (e.g., wetlands, waterbodies, and forested shelterbelts), in accordance with applicable permit conditions, as indicated on the Project construction alignment sheets and in the field by the use of staking.

(a) ROW (Permanent)

EPND's existing permanent ROW varies in width. Additional footage may be added, depending on the location of the new pipeline(s) in relation to the existing pipelines. The ROW is maintained to facilitate access and aerial inspection of the pipeline system.

(b) Temporary Workspace

In addition to the ROW/permanent corridor, construction will require Temporary Workspaces (TWS). The TWS will be located adjacent to and contiguous with the proposed ROW/permanent corridor and will be identified on the construction alignment sheets and by distinctive staking of construction limits prior to clearing.

(c) Additional Temporary Workspace

Site-specific additional temporary workspace (ATWS) locations, (construction work areas beyond the permanent corridor and TWS previously described), will be required at select locations such as steep slopes, road, waterbody, railroad, some wetland crossings, and where it is necessary to cross under the existing pipelines or foreign utilities. ATWS will typically be located in uplands adjacent to the construction ROW and set at least 50-feet back from sensitive resource boundaries where site-specific field conditions allow. However, to complete work safely, EPND may need to locate ATWS within a wetland or within the 50-foot setback from a wetland or waterbody based on site-specific conditions. ATWS adjacent to waterbodies and/or wetlands is addressed further in Sections 2.0 and 3.0, respectively.

1.6 CONTROLLING SPREAD OF UNDESIRABLE SPECIES

It is EPND's intent to minimize the potential introduction and/or spread of undesirable species (i.e., invasive species, noxious weeds, or crop diseases) along the construction ROW due to pipeline construction activities. However, it is not practicable for EPND to eradicate undesirable

species that are adjacent to the construction ROW. EPND will minimize the potential for the establishment of undesirable species by minimizing the time duration between final grading and permanent seeding.

In consultation with the applicable agencies, EPND will identify plant species that are considered noxious weeds and/or invasive plants that may occur within the counties being crossed by the pipeline corridor (refer to Appendix A).

1.6.1 Prevention and Control Measures

To prevent the introduction of the noxious weeds and invasive species identified into the Project area from other construction sites, construction equipment will be cleaned prior to arriving at the Project site. This cleaning consists of removing visible dirt from the equipment and blowing loose material from equipment using compressed air. Equipment designated for use within waterbodies will be washed and dried prior to use. Purge and clean all pumps before proceeding from one location to the next if designated noxious weeds or invasive species (e.g. zebra mussels, Eurasian milfoil, etc.) are known to be present in the area. The Contractor(s) will keep logs documenting the cleaning history of each piece of equipment and make the logs available to the EI upon request. Contractors may use the equipment cleaning log provided in Appendix A or an equivalent form approved by EPND. Equipment found to be in non-compliance with the cleaning requirement will not be allowed on the Project site until it has been adequately cleaned.

Prior to clearing and grading of the construction right-of-way and pending landowner permission, major infestation areas identified during surveys or by EPND's EIs may be treated with the recommended herbicides or their equivalents as identified through consultation with local authorities. All proposed herbicides will be reviewed and approved by EPND's Environment Department prior to use. Alternatively, full construction ROW topsoil segregation may be implemented for weed control to allow equipment to work through the area after topsoil has been stripped, as long as equipment stays on the subsoil (clearing, grading, and restoration equipment will still be cleaned). The Contractor(s) will obtain necessary permits and/or certifications for the use of the applicable herbicides, is responsible to limit off-ROW overspray, and will comply with state laws regarding the use of those herbicides. Contractor(s) will keep proper documentation of the locations where the herbicides have been used and provide such documentation to EPND within 3 days of completing the work. Weed control spraying will be restricted near certified organic farms and prohibited on certified organic farms.

Treatment of known infestation areas will be completed in accordance with applicable chemical contact times (as specified by the manufacturer) in advance of clearing and grading within the construction ROW. Treatment may be restricted in areas that are not readily accessible, such as areas where access is limited by topography or other site conditions such as saturated/inundated soils. In the event that an area is determined to be inaccessible, the EI will be notified and a site-specific alternative treatment method will be developed.

If additional noxious weed infestations are identified subsequent to herbicide applications, mechanical means (scrape down/blow down) may be used to remove weeds from tracked equipment prior to leaving the infested area. High pressure water wash stations may be established in select areas if the above measures do not adequately remove soil and vegetation debris from construction equipment. EPND will determine where this practice will be implemented. The Contractor(s) will keep logs documenting the cleaning history of each piece

of equipment and make the logs available to the EI or other EPND Representative upon request. Any equipment found to be in noncompliance with the cleaning requirement will be removed from the Project site until it has been adequately cleaned.

To prevent the spread of noxious weeds and invasive species during construction, mulch used on the Project will be composed of weed-free material. Certified weed-free mulch may also be required at site-specific locations. The Contractor(s) will be responsible for identifying and acquiring sources of weed-free and certified weed-free mulch. Sources will be approved by EPND prior to purchase.

1.7 POTHOLING/HYDROVAC SLURRY

Hydrovac excavation is used to positively identify pipelines and other buried utilities. The Contractor will construct an unlined but bermed containment area or identify comparable containment (e.g., open top tank) to hold the hydrovac slurry in an EPND and landowner-approved upland area within the construction workspace or dispose of the material off-site at a licensed disposal facility. Once the slurry is drained and dry, it may be incorporated with the subsoil in an EPND and landowner-approved upland area within the construction workspace. Discharging hydrovac slurry on to topsoil is not permitted as the material will degrade the quality of the topsoil and potentially affect revegetation.

1.8 UPLAND CLEARING

The initial stage of construction involves the clearing of brush, trees, and tall herbaceous vegetation from the ROW. Clearing may be accomplished with chain saws, mowers, and hydraulic tree-cutting equipment.

1.8.1 Disposal of Non-Merchantable Timber

Unless otherwise directed by EPND, non-merchantable timber and slash will be disposed of by mowing, chipping, grinding, and/or hauling off site to an approved disposal facility or used in stabilizing erodible slopes or construction entrances. In non-agricultural, non-wetland areas, chips, mulch, or mechanically cut woody debris may be uniformly broadcast across the ROW where the material would ultimately be incorporated into the topsoil layer during grading activities, with landowner approval (coordinated through EPND ROW agents). Burning of non-merchantable wood may be allowed only where the Contractor has acquired all applicable permits and approvals (e.g. agency, tribal, and landowner) and in accordance with all tribal, state, and local regulations. The Contractor will provide EPND with copies of these permits and/or approvals prior to initiating burning.

1.8.2 Disposal of Merchantable Timber

All merchantable timber will be managed in accordance with EPND contract specifications.

1.8.3 Upland Grading and Stump Removal

To facilitate proper cleanup and restoration in upland areas, tree stumps outside the ditch line will be ground below normal ground surface or completely removed and hauled off to an approved disposal facility. Stumps in the ditch line will be completely removed, ground, and/or hauled off to an approved disposal facility.

1.9 TEMPORARY EROSION AND SEDIMENT CONTROLS

Temporary erosion and sediment controls (ECDs) include, but are not limited to, slope breakers, sediment barriers (i.e. silt fence, straw bales, bio-logs, etc.), stormwater diversions, trench breakers, mulch, and revegetation subsequent to seeding of exposed soils (refer to Figures 4 through 11). The Contractor will maintain erosion and sediment control structures as required in Project construction documents and as required by all applicable permits. Non-functional erosion and sediment controls will be repaired, replaced, or supplemented with functional materials within 24 hours after discovery, or as otherwise specified in the Project permits. ECDs will be installed after initial clearing but before grading activities, and will be replaced by permanent erosion controls as restoration is completed.

Temporary ECDs will be installed after clearing and prior to grubbing and grading activities at the base of sloped approaches to streams, wetlands, and roads. Temporary ECDs will also be installed at the edge of the construction ROW as needed, and/or in other areas determined by the EI to slow water leaving the site and prevent siltation of waterbodies and wetlands down slope or outside of the construction ROW (e.g., swales and side slopes). Temporary ECDs will be placed across the entire construction ROW at the base of slopes greater than 5 percent where the base of the slope is less than 50 feet from tile line inlets, drainage ways, wetlands, and/or waterbodies until the area is revegetated and there is no potential scouring or sediment transport to surface waters. Adequate room will be available between the base of the slope and the sediment barrier to accommodate ponding of water and sediment deposition.

If silt fence is used, when the depth of sediment reaches about one-third of the height, the sediment will be removed. Non-functional ECDs will be repaired, replaced, or supplemented with functional structures within 24 hours after discovery, or as otherwise specified in the Project permits.

Temporary ECDs installed across the travel lane may be removed during active daytime construction; however, ECDs will be properly reinstalled after equipment passage, or activities in the area are completed for the day. These ECDs will also be repaired and/or replaced prior to inclement weather when forecasted.

1.9.1 Temporary Stabilization

Installation of temporary seeding, mulch (straw or hydromulch), and erosion control mats may be required by EPND in certain locations (including topsoil piles) if there are construction delays within a spread of at least 14 days. The Contractor may be required by EPND to install temporary stabilization materials sooner based on site conditions, or as required in Project permits.

1.9.2 Erosion Control Blanket

The appropriate class of erosion control blanket will be installed in accordance with manufacture recommendations and/or state Department of Transportation (DOT) specifications on slopes greater than 5 percent that would be exposed over the winter and drain to surface waters (refer to Figures 8 and 9). The Contractor will attempt to install erosion control blankets on the exposed slopes prior to snowfall; however, construction progress and/or seasonal weather variations may prevent installation prior to the first snowfall. Installation of erosion control blankets and additional BMPs, as applicable based on site conditions, is required after the first

snowfall to protect slopes prior to spring melt and runoff. Erosion control blankets will be installed running parallel (up and down) with the direction of the slope (not perpendicular).

1.9.3 Mulch

Mulch (weed-free straw, wood fiber hydromulch, or a functional equivalent) will be applied to disturbed areas (except for actively cultivated land and wetlands) if requested by the landowner or land managing agency, if specified by the applicable permits or licenses, or as required by EPND. Mulch will specifically be required on:

- Slopes greater than 5 percent; and
- Dry, sandy areas that can blow or wash away (field decision).

Mulch will be free of noxious weeds as listed in applicable state laws. Certified weed-free mulch may also be required at site-specific locations. The Contractor will be responsible for identifying and acquiring sources of weed-free and certified weed-free mulch. Sources will be approved by EPND prior to purchase.

Mulch will be applied at a rate of 2 tons per acre to cover at least 75 percent of the ground surface unless otherwise stipulated by permit conditions. Mulch will be uniformly distributed by a mechanical mulch blower, or by hand in areas not accessible to the mulch blower. Mulch will be anchored/cripped using a mulch-anchoring tool or disc set in the straight position to minimize loss by wind and water, as site conditions allow. In areas not accessible to a mulch-anchoring tool or too steep for safe operation, the mulch may be anchored by liquid tackifiers, with advance written approval from EPND. The manufacturer's recommended method and rate of application will be followed.

Hydro-mulch and liquid tackifier can be used in place of straw or weed-free hay mulch with prior approval from EPND. All hydromulch and liquid tackifier products used will be on the applicable state DOT product list. Application rates will be at the manufacturer's recommended rate, equal to or greater than 2 tons per acre of straw mulch.

1.9.4 Cat Tracking

Cat tracking, also known as horizontal slope grading, may be implemented based on site conditions (sandy or silt soils) to reduce erosion potential. Cat tracking is achieved by driving a bulldozer vertically up and down the slope which results in the tracks being oriented horizontally; creating small speed bumps for water (refer to Figure 11).

1.9.5 Temporary Slope Breakers

Temporary slope breakers will be installed to minimize concentrated or sheet flow runoff in disturbed areas in accordance with the following maximum allowable spacing unless otherwise specified in permit conditions.

<u>Slope (%)</u>	<u>Approximate Spacing (ft)</u>
3-5	250
5-15	200
15-25	150
>25	<100

If the length of the slope is less than the distance of the required spacing, slope breakers are not required unless a sensitive resource area (e.g., wetland or public roadway) is located immediately down slope, or as requested by the EI. Temporary slope breakers may be constructed using earthen subsoil material, silt fence, straw bales, or in non-agricultural land, rock-filled trenches may be used. On highly erodible slopes, slope breakers in the form of earthen berms will be used whenever possible.

Temporary slope breakers will be constructed according to the following specifications (refer to Figures 4 and 5):

- straw bales used as slope breakers will be trenched in and staked so as to not allow spacing between bales or allow flow underneath the bales;
- the outfall of temporary slope breakers will be directed off the construction ROW into a stable well-vegetated upland area or into an appropriate energy-dissipating sediment control device (e.g., silt fence, straw bales, rock aprons) to prevent the discharge of sediments (refer to Figure 4);
- proper slope breaker outfalls will be established where topsoil segregation and/or grading has created a barrier at the edge of the construction workspace; and
- gaps will be created through spoil piles where necessary to allow proper out letting of temporary berms.

1.10 UPLAND TOPSOIL SEGREGATION

Upland areas where topsoil will be stripped includes cropland, hay fields, pasture, residential areas, and other areas as requested by the Landowner or as specified in the Project plans, commitments, and/or permits. Topsoil will not be used to construct berms, trench breakers, temporary slope breakers, improving or maintaining roads, or to pad the pipe. Berms used for stacking pipe in pipe yards may be constructed using topsoil if landowner permission and necessary approvals are obtained. Gaps will be left and ECDs installed where stockpiled topsoil and spoil piles intersect with water conveyances (i.e., ditches, swales, and waterways) to maintain natural drainage.

Topsoil Segregation Methods

The following topsoil segregation methods may be employed during construction:

- Modified Ditch-Plus-Spoil Side (refer to Figure 1)
- Full Construction ROW (refer to Figure 2)
- Trench-Line-Only (refer to Figure 3)

A Modified Ditch-Plus-Spoil topsoil segregation technique will typically be used in active cropland, which will consist of stripping topsoil from the spoil storage area, ditch line, and the primary travel lane. The Trench-Line-Only topsoil segregation method may be used where EPND determines that the width of the construction ROW is insufficient for other methods to be used. EPND may also use the Trench-Line-Only topsoil segregation method in areas where

there is a thick sod layer such as in hay fields, pastures, golf courses, and residential areas, unless otherwise requested by the landowner. Alternative topsoil segregation methods may be used on a site-specific basis or as requested by the landowner. Topsoil is not typically segregated in standing water wetlands unless specifically requested by the landowner and/or managing land agency in accordance with applicable permit conditions.

Depth of Upland Topsoil Stripping

In deep soils (more than 12 inches of topsoil), topsoil will be stripped to a minimum depth of 12 inches, unless otherwise specified/requested by other plans, permit conditions, or the landowner. Additional space may be needed for spoil storage if more than 12 inches of topsoil are segregated. If less than 12 inches of topsoil are present, the Contractor will attempt to segregate to the depth that is present.

1.11 UPLAND TRENCHING

Trenching in uplands is typically accomplished with a backhoe excavator or a rotary wheel ditching machine. Excavated material will be side cast (stockpiled) within the approved construction ROW separate from topsoil, and stored such that the area subject to erosion is minimized. EPND will coordinate with landowners to minimize disruption of access caused by the trench during construction. Where deemed appropriate by EPND, the Contractor will leave plugs of subsoil in the ditch or will construct temporary access bridges across the trench for the landowner to move livestock or equipment. Trenches may also be sloped where started and ended to allow ramps for wildlife to escape. Spacing of plugs and ramps will be determined in the field.

1.11.1 Timing

The length of time a trench is left open will be minimized to ensure that installation of the pipe and restoration of the construction ROW occurs in a timely fashion. Therefore, unless otherwise specified by Project permits or EPND, the Contractor will limit the amount of excavated open trench to a maximum of 3 days of anticipated welding production per spread, per pipe. This timeframe may be decreased at the discretion of EPND based on site conditions. Site-specific activities such as horizontal directional drilling, guided bores, road bores, tie-in points, and valve work may be performed independent of a spread.

1.12 FOAM PILLOW INSTALLATION

Use of foam pillows for pipe protection in the trench will be approved by EPND in advance and installed in accordance with applicable Project permits, local/state/federal regulations, and manufacturer's recommendations.

1.13 TRENCH BREAKERS

Trench breakers will be installed as deemed necessary by EPND in sloped areas after the pipe has been lowered into the trench. Trench breakers protect against subsurface water flow along the pipe after the trench is backfilled. Trench breakers will be constructed with bags filled with rock-free subsoil or sand. Use of foam trench breakers will be approved by EPND in advance and installed in accordance with applicable Project permits, local/state/federal regulations, and manufacturer's recommendations. Trench breakers will be placed from the bottom of the trench to near the top of the trench, completely surrounding the pipe and will be properly keyed into the undisturbed trench walls (refer to Figures 12 and 13). The location for trench breakers will be based on field conditions including the degree and length of slope, presence of down slope

sensitive resource areas such as wetland and waterbodies, and proximity to other features such as roads and/or railroads. The following conditions apply to the placement and installation of trench breakers unless otherwise directed by EPND:

- Trench breakers will be installed on slopes greater than 5 percent adjacent to streams, wetlands, or other waterbodies.
- Topsoil cannot be used to construct trench breakers.
- Where the pipeline exits a wetland towards areas of lower relief, trench breakers will be installed (within the upland) where there is a potential for underground drainage along the pipe in order to prevent wetland or waterbody drainage.
- At all waterbody crossings, as necessary, to prevent diversion of water into upland portions of the pipeline trench and to keep accumulated trench water out of the waterbody.

The actual location of each trench breaker will be selected through coordination between EPND's EIs, EPND's Craft Inspectors, and the Contractor's Foreman for backfilling activities.

1.14 DRAIN TILE INLET PROTECTION AND TILE REPAIRS

EPND will attempt to locate existing drain tile inlets that are located near the construction work area prior to construction. Drain tile inlets will be marked using flags. The Contractor will protect located drain tile inlets with the potential to receive stormwater from the construction Project using the appropriate ECDs until sources with the potential to discharge have been stabilized. The determination of the specific ECD will be made based on the location of an inlet with respect to the Project area, drainage area from the construction work area to the inlet, topography, vegetation, soils, and accessibility to the inlet. Where drain tile inlets are located off of EPND's construction ROW, EPND may not have authorization to install ECDs at the inlet site. In these cases, sediment control measures (typically silt fence) will be installed along the edge of the construction work area that drains to the inlet structure to minimize sedimentation.

If underground drainage tile is damaged by pipeline construction, it will be repaired in a manner that assures proper tile line operation at the point of repair in accordance with the Agricultural Protection Plan.

1.15 UPLAND BACKFILLING

Backfilling follows pipe installation and consists of replacing the material excavated from the trench. In areas where topsoil has been segregated, the subsoil will be replaced first, and the topsoil will be spread uniformly over the area from which it was removed. Prior to backfilling, the trench will be dewatered in accordance with the methods discussed in Section 5.0 if water obscures the trench bottom.

1.16 CLEANUP AND ROUGH/FINAL GRADING

All waste materials, including litter generated by construction crews, will be disposed of daily by the Contractor. Initial cleanup and rough grading activities may take place simultaneously. Cleanup involves removing construction debris (including litter generated by construction crews and excess rock) and large woody debris. Rough and final grading includes restoring disturbed areas as near as practicable to preconstruction conditions, returning the topsoil where topsoil

has been stripped, preparing a seedbed and de-compacting subsoil (where applicable) for permanent seeding, installing or repairing temporary erosion control measures, repairing/replacing fences, and installing permanent erosion controls.

1.16.1 Timing

The Contractor will begin cleanup and rough grading (including installation of temporary erosion and sediment control measures) within 72 hours after backfilling the trench. The Contractor will attempt to complete this rough cleanup within one week. The Contractor will initiate final grading, topsoil replacement, seeding, and installation of permanent erosion control structures within 14 days after backfilling the trench. If seasonal or other weather conditions prevent compliance with these timeframes, temporary erosion controls will be maintained until conditions allow completion of cleanup.

1.17 PERMANENT EROSION AND SEDIMENT CONTROLS

During final grading, slopes in areas other than cropland will be stabilized with erosion control structures. With exception to actively cultivated areas, permanent berms (diversion dikes or slope breakers) will be installed on all slopes, according to the following maximum spacing requirements unless otherwise specified in permit conditions:

<u>Slope (%)</u>	<u>Approximate Spacing (ft)</u>
3-5	250
5-15	200
15-25	150
>25	<100

Permanent berms will be constructed according to the following specifications:

- Permanent berms will be constructed of compacted earth, stone, or functional equivalent as approved in advance by EPND.
- The outfall of berms will be directed toward appropriate energy-dissipating devices, and off the construction ROW if possible.
- Permanent berms will be inspected and repaired as deemed necessary by EPND to maintain function and prevent erosion.
- Erosion control blankets (curlex, jute, or equivalent) will be placed on slopes over 30 percent or that are a continuous slope to a sensitive resource area (e.g., wetland or waterway).

1.18 SOIL COMPACTION TREATMENT

Cultivated fields and compacted or rutted areas will be tilled prior to topsoil replacement with a deep tillage device or chisel plowed to loosen compacted subsoils. If subsequent construction and cleanup activities result in further compaction, additional measures will be undertaken to alleviate the soil compaction.

1.19 STONE REMOVAL

A diligent effort will be made to remove excess stones equal to or larger than 4 inches in diameter from the upper 8 inches of subsoil or as specified in permit conditions, contract documents, or landowner agreements. After the topsoil is replaced, stone removal efforts will cease when the size and density of stones on the construction ROW are similar to undisturbed

areas adjacent to the construction ROW as determined by the EI. Excess rock will be piled in upland areas where landowner permission has been obtained, or will be hauled off-site to an EPND approved disposal site.

1.20 REPAIR OF DAMAGED CONSERVATION PRACTICES

The Contractor will restore all soil conservation practices (such as terraces, grassed waterways, etc.) that are damaged by the pipeline construction to preconstruction conditions to the extent practicable.

1.21 LAND LEVELING FOLLOWING CONSTRUCTION

Following the completion of the pipeline, the construction ROW will be restored to its pre-construction conditions as practical. Should uneven settling or documented surface drainage problems occur following the completion of pipeline construction and restoration, EPND will take appropriate steps to remedy the issue.

2.0 STREAM AND RIVER CROSSING GENERAL REQUIREMENTS

The procedures in this section apply to streams, rivers, and other waterbodies such as jurisdictional ditches, ponds, and lakes. These procedures require that judgment be applied in the field and will be implemented under the supervision of EPND.

Stream crossing requirements, including construction methods, timing, erosion control, and restoration are described in this section and in the stream crossing permits issued by state and federal agencies and by tribal authorities (as applicable). If the contractor considers certain parts of these procedures to be technically impractical due to site-specific engineering constraints, they may submit a request to EPND for approval of alternative measures that would provide an equal or greater level of protection to stream and river ecosystems. EPND will review the contractor's alternatives and consult with appropriate regulatory agencies and tribal resource specialists (as applicable). The contractor will receive written approval from EPND prior to implementing the alternatives. During wet and high runoff conditions, the EI will determine whether conditions warrant additional considerations for construction activities.

2.1 TIME WINDOW FOR CONSTRUCTION

All in-stream work activities (installation of dams, sheet piling, etc.) will be minimized to the extent practicable on an area and time duration basis. In-stream trenching will be conducted during periods permitted by the appropriate regulatory agencies and applicable permits. Unless otherwise specified in applicable permits and with exception to blasting and other rock breaking measures and directional drill, in-stream construction activities (specifically trenching, pipeline installation, backfill, and restoration of the streambed contours) for wet crossing methods will occur within the following timeframes:

- Minor Waterbodies (all waterbodies less than or equal to 10 feet wide at the water's edge at the time of crossing): 24 hours
- Intermediate Waterbodies (all waterbodies greater than 10 feet wide but less than 100 feet wide at the water's edge at the time of crossing): 48 hours
- Major Waterbodies (all waterbodies greater than 100 feet wide at the time of crossing): As specified by EPND or in the applicable permits.

These timeframes apply regardless of the presence or absence of flow. These timeframes also apply to dry crossing methods as a guideline and can be extended based on site-specific conditions with approval from EPND Environment staff, Construction Management, and the EI.

Stream crossings will be designed as close to perpendicular to the axis of the stream channel as engineering and routing constraints allow, creating the shortest crossing length.

2.2 CLEARING AND GRADING

The construction ROW width will consist of a 15-foot-wide neck down beginning 50 feet from the ordinary high water mark (OHWM) / ordinary high water level on the working side of the right-of-way. A 25-foot-wide neck down will be implemented on the spoil side of the construction ROW beginning 20 feet from the OHWM/OHWL (refer to Figures 15 through 17).

2.2.1 Impaired Waters

Where discharges of stormwater may occur to waters designated under Section 303(d) of the Clean Water Act as Impaired Waters, additional BMPs will be implemented as specified in the applicable Project permits.

2.3 ADDITIONAL TEMPORARY WORKSPACE

ATWS includes work areas outside the boundary of the typical construction ROW. These spaces are typically used to assemble pipe segments and for temporary spoil storage. Clearing of forested and brushy areas for ATWS will be avoided as much as possible. Woody vegetation in wetlands and riparian areas will typically not be cleared for the purpose of ATWS unless approved by appropriate regulatory agencies as stipulated in permits issued for the Project. ATWS will be constructed as follows:

- ATWS will be located at least 50 feet away from the OHWM/OHWL if topographic or other physical conditions such as stream channel meanders allow (refer to Figures 15 through 17).
- If safe work practices or site conditions do not allow for a 50-foot setback, ATWS should be located no closer than 20 feet from the OHWM/OHWL, subject to site-specific approval by EPND.
- ATWS will be limited to the minimum size needed to construct the stream crossing.

2.4 BRIDGES

Temporary equipment bridges will be used on most waterways (upon approval by the appropriate agency), including small waterways such as ditches and intermittent streams, where there is a potential for stormwater runoff or rain events to transport sediment downstream from equipment crossing the waterway. Bridges will be constructed as described below and will be removed as soon as possible during final restoration. Bridges will not typically be installed at directionally drilled waterbodies, unless there is no reasonable alternative that provides an efficient, economical way to transport heavy construction equipment around the waterbody by truck.

With exception to clearing-related equipment, fording of waterways is prohibited (i.e. civil survey, potholing, or other equipment are not permitted to ford waterways prior to bridge placement). Clearing equipment and equipment necessary for installation of equipment bridges will be allowed a single pass across waterbodies prior to bridge installation, unless restricted by applicable permits.

2.4.1 Types of Bridges

Equipment bridges will be constructed using one of the following techniques:

- Typical Span Type Bridge (timber mats - refer to Figure 19)
- Rock Flume (refer to Figure 20)
- Railroad flat cars
- Flexi-float or other pre-fabricated portable bridges
- Other methods as approved by EPND and appropriate agencies

2.4.2 Bridge Design and Maintenance

Bridges will be designed as close to perpendicular to the axis of the stream channel, creating the shortest crossing length and will be built and maintained in accordance with applicable permits. Equipment bridges will be designed to withstand the maximum foreseeable flow of the stream with headers and support structures being placed above the ordinary high water mark (OHWM) of the feature. Local jurisdictions may require stricter guidelines associated with bridge placement. Bridges will not restrict flow or pool water while the bridge is in place, and will be constructed with clean materials. Bridges will be designed and maintained to prevent soil from entering the waterbody. Soil that accumulates on the bridge decking will be removed as needed, or as deemed necessary by the EI.

2.5 STREAM AND RIVER CROSSING CONSTRUCTION METHODS

The following stream and river crossing methods are typically used, subject to further restrictions by EPND and applicable permits and subject to modifications as approved by appropriate regulatory agencies and tribal resource specialists (as applicable) during construction.

2.5.1 Wet Trench Method

Installation

The wet trench method will be used to cross streams and rivers not permitted to be flumed, dam and pumped, or directionally drilled. The following procedures will be used during wet trench crossings:

- Sediment control measures will be installed before grading from the 20-foot vegetative buffer left on each stream bank. Spoil containment structures will be installed back from the stream bank so that spoil does not migrate into the stream.
- Grading will be directed away from the waterbody to minimize the potential for sediment to enter the stream. Grading of stream banks will be restricted to the trench line and areas necessary for safe bridge installation.
- After grading, backhoes or draglines will be used to excavate the trench. Where possible, excavating equipment will operate from one or both banks, without entering the stream. If equipment must encroach into the stream, it will operate on clean construction mats. Streambed material will be segregated (e.g., upper one foot and the remaining trench spoil will be stored separately) and placed within a spoil containment structure in approved construction work area limits. Storage of streambed spoil within the stream will only be allowed if expressly approved in the applicable permits.
- Earthen trench plugs (hard plugs) between the stream and the upland trench will be left undisturbed during excavation of the in-stream trench to prevent diversion of the stream flow into the open trench and to prevent water that may have accumulated in the adjacent upland trench from entering the waterbody. Trench plugs will be removed immediately prior to pipe placement, and then replaced when the pipe is in place. Trench water accumulated upslope of trench plugs will be dewatered appropriately prior to trench plug removal.
- Water within the trench will be managed in accordance with Section 5.0
- Backfilling will begin after the pipe is positioned in the trench at the desired depth. Backfill material will consist of the spoil material excavated from the trench and parent streambed unless otherwise specified in state or federal permits. The in-stream trench will be backfilled so that the stream bottom is as near as practicable to its pre-construction condition, with no impediments to normal water flow.

Temporary Stabilization

The Contractor will restore the stream banks as near as practicable to pre-construction conditions unless that slope is determined to be unstable. If EPND determines the slope is considered unstable, the Contractor will reshape the banks to prevent slumping. Once the banks have been reshaped, ECDs will be installed within 24 hours of backfilling the crossing. Temporary slope breakers will be installed on all sloped approaches to streams in accordance with the spacing requirements previously specified.

A temporary seed mix (e.g., annual rye or annual oats) and mulch and/or erosion control blankets will be installed within a 50-foot buffer on either side of the stream, with exception to actively cultivated land. Silt fence or functional equivalent as approved in advance by EPND will be installed upslope of the temporary seeding area.

2.5.2 Dam and Pump Method

Installation

The dam and pump method is a dry crossing technique that is suitable for low flow streams and is generally preferred for crossing meandering channels. The dam and pump method involves damming of the stream upstream and downstream of the proposed trench before excavation (refer to Figure 16) and pumping water around the construction area. The following procedures will be used for dam and pump crossings:

- Dams may be constructed of sandbags, inflatable dams, aqua-dams, sheet piling, and/or steel plates. The dams will prevent the stream from flowing into the construction area. The dams will be continuously monitored for a proper seal. Additional sandbags, plastic sheeting, steel plating, or similar materials will be used where necessary to minimize the amount of water seeping around the dams and into the construction work area. The dam will not be removed until after the pipeline has been installed, the trench has been backfilled, and the banks have been stabilized.
- Pumping of the stream across the ROW will commence simultaneously with dam construction to prevent interruption of downstream flow. Stream flow will be pumped across the construction area through a hose and will be discharged to an energy-dissipation device, such as plywood boards, to prevent scouring of the streambed.
- The pumps and fuel containers will be located on the upstream side of the crossing and will be placed in impermeable, sided structures which will act as containment units (refer to Section 10.0). The pumps used for this crossing method will not be placed directly in the stream or on the streambed. Pumps will have a capacity greater than the anticipated stream flow. The pumping operation will be staffed 24 hours a day and pumping will be monitored and adjusted as necessary to maintain an even flow of water across the work area and near-normal water levels upstream and downstream from the crossing. .

The pump intake will be suspended to prevent sediment from being sucked from the bottom of stream and will be equipped with a screen, or equivalent device, to prevent fish uptake.

- Where possible, excavating equipment will operate from one or both banks, without entering the stream. If equipment must encroach into the stream, it will operate on clean construction mats (free of soil and plant material prior to being transported onto the construction ROW). Streambed material will be segregated as stated in the wet trench method and will be placed within a spoil containment structure in approved construction work area limits. Storage of streambed spoil within the stream will only be allowed if expressly approved in the applicable permits.
- Earthen trench plugs (hard plugs) between the stream and the upland trench will be left undisturbed during excavation of the in-stream trench to prevent diversion of the stream flow into the open trench and to prevent water that may have accumulated in the adjacent upland trench from entering the waterbody. Trench plugs will be removed

immediately prior to pipe placement, and then replaced when the pipe is in place. Trench water accumulated upslope of trench plugs will be dewatered appropriately prior to trench plug removal.

- Standing water that is isolated in the construction area by the dams will be managed in accordance with Section 5.0
- Backfilling will begin after the pipe is positioned in the trench to the desired depth. Backfill material will consist of the spoil material and parent streambed excavated from the trench unless otherwise specified in state or federal permits. The in-stream trench will be backfilled so that the stream bottom is similar to its pre-construction condition, with no impediments to normal water flow.

Temporary Stabilization

Restoration of the stream banks and the installation of temporary erosion controls will be similar to that described for the wet trench method above but will occur immediately following installation of the pipeline. Once the stream banks have been stabilized, the dams and pump will be removed.

2.5.3 Flume Method

Installation

The flume method is a dry crossing technique that is suitable for crossing relatively narrow streams that have straight channels and are relatively free of large rocks and bedrock at the point of crossing (refer to Figure 17). This method involves placement of flume pipe(s) in the stream bed to convey stream flow across the construction area without introducing sediment to the water. The procedures for using the flume method are described below.

- The flume(s) will be of sufficient diameter to transport the maximum flows anticipated to be generated from the watershed. The flume(s), typically 40 to 60 feet in length, will be installed before trenching and will be aligned so as not to impound water upstream of the flume(s) or cause downstream bank erosion. The flumes will not be removed until after the pipeline has been installed, trench has been backfilled, and the stream banks have been stabilized.
- The upstream and downstream ends of the flume(s) will be incorporated into dams made of sand bags and plastic sheeting (or equivalent). The upstream dam will be constructed first and will funnel stream flow into the flume(s). The downstream dam will prevent backwash of water into the trench and construction work area. The dams will be continuously monitored for a proper seal. Adjustments to the dams will be made where necessary to prevent large volumes of water from seeping around the dams and into the trench and construction work area.
- Where possible, excavating equipment will operate from one or both banks, without entering the stream. If equipment must encroach into the stream, it will operate on clean construction mats. Streambed material will be segregated and placed within a spoil containment structure in approved construction work area limits. Storage of streambed

spoil within the stream will only be allowed if expressly approved in the applicable permits.

- Earthen trench plugs (hard plugs) between the stream and the upland trench will be left undisturbed during excavation of the in-stream trench to prevent diversion of the stream flow into the open trench and to prevent water that may have accumulated in the adjacent upland trench from entering the waterbody. Trench plugs will be removed immediately prior to pipe placement, and then replaced when the pipe is in place. Trench water accumulated upslope of trench plugs will be dewatered appropriately prior to trench plug removal.
- If additional trench dewatering is necessary to complete the installation of the pipe, the discharge will be managed in accordance with Section 5.0.
- Backfilling will begin after the pipe is positioned in the trench to the desired depth. Backfill material will consist of the spoil material excavated from the trench and parent streambed unless otherwise specified in state or federal permits. The in-stream trench will be backfilled so that the stream bottom is similar to its pre-construction condition, with no impediments to normal water flow.

Temporary Stabilization

Restoration of the ROW and the installation of temporary erosion controls will be similar to that described for the wet trench method above but will occur immediately following installation of the pipeline. After the stream banks have been stabilized, the dams and flume will be removed from the stream bed allowing water to resume its flow in the channel.

2.5.4 Directional Drill and/or Guided Bore Method

Installation

Installing the pipe underneath a stream will involve placing a drill unit on one side of the stream (refer to Figure 18). A small-diameter pilot hole will be drilled under the stream along a prescribed profile. After the pilot hole has been completed, barrel reams will be used to enlarge the pilot hole to accommodate the desired pipeline diameter. Drilling mud will be necessary to remove cuttings and maintain the integrity of the hole. Water from an EPND-approved source will be used to prepare the slurry of drilling mud, and will be appropriated according to applicable permits. The pipe section will be pulled through the hole by the drilling rig and welded to the adjoining sections of pipe on each side of the river.

Drilling Mud

During drilling operations, drilling mud and slurry will be stored back from the waterbody in an earthen berm sediment control structure, in tanks, or by other methods so that it does not flow into the waterbody, adjacent wetlands or off the workspace (refer to Section 11.0 for additional details).

After the pipe is in place, excess drilling mud will be hauled off-site to an EPND-approved disposal location or licensed disposal facility.

Temporary Stabilization

The directional drilling/guided bore method normally does not result in the disturbance of the stream banks or riparian vegetation (with exception to extremely limited hand clearing of woody required to facilitate guide wire placement), which reduces the potential for erosion and sedimentation at the stream crossing. Consequently, temporary erosion control measures that are installed at open-cut crossings typically are not necessary for drilled/bored crossings.

2.6 PERMANENT RESTORATION

Stream banks disturbed during installation of the pipelines will be stabilized with erosion control materials such as an erosion control blanket and seeded in accordance with Section 7.0. Permanent stabilization will be initiated within 24 hours after installation of the crossing using the wet trench method and prior to restoring flow using the dam and pump or flume method, unless site and permit conditions delay permanent installation. Where the banks have been disturbed, the Contractor will restore the slopes as near as practicable to pre-construction conditions unless that slope is determined by EPND to be unstable. Where the slope of the banks is determined to be unstable or has the potential to erode or fail, the banks will be reshaped to transition the disturbed areas into the natural stream bank with the intent to stabilize the bank and create a blended, natural appearance.

Berms or other sediment filter devices will be installed at the base of sloped approaches to streams greater than five percent and the outlet of the berm will be directed away from the stream into a well vegetated area. Temporary sediment control devices will remain in place until the area has stabilized and adequate revegetation has established.

2.6.1 Vegetative Bank Restoration

Typically, waterbody banks will be restored as near as practicable to preconstruction conditions after backfilling is complete and will be seeded with an appropriate seed mix as specified in Section 7.0 and covered with an erosion control blanket. Erosion controls, (e.g. straw bales, bio-logs, silt fences, etc.) will be installed as necessary based on site-specific conditions.

2.6.2 Supplemental Bank Stabilization

Unstable soils and/or site-specific factors such as stream velocity and flow direction may require additional restoration efforts, such as installation of rock rip-rap, to stabilize disturbed stream banks. Rock rip-rap will be used only where site-specific conditions require and where applicable permits or approvals have been acquired. Geotextile fabric and rock riprap will be placed according to site and permit conditions (refer to Figure 23). Disturbed soils upslope and on either side of the riprap will be prepared for seeding according to Section 7.0 and other stream bank protection requirements. Bioengineering techniques may also be implemented as determined by EPND (refer to Figures 26 through 28).

2.6.3 Bridge Removal

Equipment bridges will be removed during final cleanup or, if access is needed, after final cleanup and permanent seeding. Restoration of the bridge area will be completed upon bridge removal.

2.6.4 Swales

Swales will be restored as near as practicable to original conditions. Swales will be seeded and either mulched with straw or erosion control blankets will be installed to the perceivable top of bank for the width of the construction ROW.

3.0 WETLAND CROSSING GENERAL REQUIREMENTS

The procedures in this section apply to all wetlands that will be affected by the Project. These procedures require that judgment be applied in the field and will be implemented under the supervision of EPND and the EI. The intent of these procedures is to minimize construction-related disturbance and sedimentation of wetlands and to restore wetlands as nearly as possible to pre-existing conditions.

Wetland crossing requirements, including construction methods, timing, erosion control, and restoration, are described in this section and in the wetland crossing permits issued by state, federal and/or tribal agencies as applicable. If the contractor considers certain parts of these procedures to be technically impractical due to site-specific engineering constraints, they may submit a request to EPND for approval of alternative measures. EPND will review the contractor's alternatives and consult with appropriate regulatory agencies. The contractor must receive approval from EPND prior to implementing the alternatives.

3.1 WETLAND ACCESS

The Contractor will use the construction ROW and only approved roads to access wetland areas.

3.2 CLEARING

Clearing the construction ROW in wetlands will be similar to clearing in uplands. For construction to proceed, obstructions (e.g., trees, brush, and logs) need to be removed. Typically, low ground pressure equipment will be used, limiting disturbance to the wetland. Vegetation and trees within wetlands will be cut off at ground level, leaving existing root systems intact; clearing debris will generally be removed from the wetland for disposal. Hydro-axe debris, or similar can be left in the wetland if spread evenly in the construction ROW to a depth which will allow for normal revegetation, as determined by the EI.

3.3 ADDITIONAL TEMPORARY WORKSPACE IN WETLANDS

In general, EPND attempts to locate ATWS outside of wetlands wherever practicable; however, ATWS may be sited in select wetlands where the wetland is adjacent to a waterbody, road, railroads, foreign utility crossings, and/or pipeline cross-over with prior approval from the applicable regulatory agencies. Clearing of forested wetlands for ATWS will be avoided as much as possible.

- Staging areas, additional spoil storage areas, and other ATWS will be located in upland areas at least 50 feet away from wetland boundaries (refer to Figures 24), where safe work practices or site conditions permit. If site conditions do not permit a 50-foot setback, then these areas will be located as far away from the wetland as is practicable. Vegetation will not be cleared between these areas and the wetland in any event. No construction activities including vegetation clearing or earthwork will occur between the ATWS and the wetland.
- The size of the ATWS areas will be limited to the minimum needed to construct the wetland crossing.

3.4 GRADING IN A WETLAND

Grading activities will be confined to the area of the trench and will be minimized to the extent practicable. Grading outside the trench will only be allowed where required to ensure safety and restore the construction ROW after backfilling the trench with prior approval from EPND.

ECDs will be installed:

- across the entire construction ROW upslope of the wetland boundary, where necessary, to prevent sediment flow into the wetland;
- along the edge of the construction ROW as necessary to prevent sediment flow into off-ROW wetlands; and
- Along the edge of the construction ROW as necessary to contain spoil and sediment within the construction ROW through wetlands.

ECDs will be maintained in proper working order to prevent the flow of sediment into wetlands from spoil piles or sloped approaches that are adjacent to the wetlands. .

3.5 RIGHT-OF-WAY STABILIZATION

Tree stumps, brush riprap, imported soil, and rock fill will not be brought in to stabilize the right-of-way in wetlands. Where low ground pressure equipment is not used, construction equipment will operate from timber construction mats or equivalent means with prior approval from EPND (refer to Figure 24). To prevent the spread of noxious and invasive plant species, timber mats will be free of soil and plant material prior to being transported onto the construction ROW and/or moved from one area of the construction ROW to another area. Timber riprap (also known as corduroy road) will not be used without prior written approval from EPND and the appropriate regulatory agencies. Pre-existing corduroy roads in wetlands may be used but may not be improved, maintained, restored, or replaced without site-specific authorization from applicable agencies.

Subsoil from the pipeline trench within the immediate wetland may be placed on top of equipment mats for additional stabilization. Timber mats may be placed over the ditch line or on the working side to facilitate trench excavation. All timber mats, construction debris, and larger woody vegetative debris will be removed during cleanup of wetlands.

3.6 TRENCHING

Excavation of the pipeline trench in wetlands typically will be accomplished using backhoe excavators. The Contractor will take reasonable steps to insure that the duration of open trench in wetlands, including tie-ins, is minimized to the fullest extent possible.

3.6.1 Topsoil Segregation

When constructing in wetland areas without standing water, up to one foot of topsoil (organic layer) will be stripped from the trench line and stockpiled separate from trench spoil to preserve the native seed stock. In standing water wetlands, organic soil segregation is not typically practical; however, the Contractor will attempt to segregate as much of the organic layer as possible based on site/saturation conditions. If normally unsaturated wetlands are saturated at the time of construction, topsoil segregation will be attempted according to Figure 3 and based on recommendations from the EI and appropriate regulatory agencies.

3.6.2 Trench Breakers

Where the EI determines that the pipeline trench has the potential to drain or partially drain a wetland, trench breakers will be installed as necessary to maintain the original wetland hydrology.

3.7 PIPELINE INSTALLATION

The following procedures are intended to minimize siltation and disturbance to wetlands during installation.

3.7.1 Push/Pull Method

Large wetlands with standing water can generally not be crossed with typical crossing methods. In these areas, the pipeline will be assembled in an upland area and positioned in the trench using the "push-pull" and/or "float" techniques.

Usually this fabrication requires use of ATWS adjacent to the construction ROW. A backhoe (or equivalent) supported on timber mats or equivalent low ground pressure equipment will be used to dig the trench. . The prefabricated section of pipeline will then be pushed-pulled into position or floated across the wetland. When the pipeline is in position, floats, if used, will be removed and the pipeline will sink into position. The trench will then be backfilled and a backhoe or similar equipment working from construction mats or by low ground pressure equipment will be used restore the wetland.

3.7.2 Temporary Erosion and Sediment Controls

ECDs at approaches to wetlands will be installed as previously described and in accordance with Section 1.0.

3.7.3 Concrete Coating

Concrete will generally be mixed off-site, and concrete coated pipe will be transported to the construction ROW on trucks. If required, pre-fabricated concrete weights and/or saddlebag weights will also be used to provide negative buoyancy. Concrete weights will be manufactured off-site and transported to the ROW. Weights will be strung along the construction ROW, where necessary, until they are placed over the pipe within the excavated ditch. Limited mixing and coating activities may occur on the construction ROW for coating pipe joints and concrete weight repairs according to the concrete usage specifications in Section 10.0. Washing equipment used for mixing, pouring, casting, or coating will not be conducted within 100 feet of any wetland and will be conducted and contained in a leak-proof containment facility or impermeable liner. The EI will determine where ECDs will be installed down slope of equipment wash areas to capture sediments and minimize erosion from runoff.

3.8 BACKFILLING

Subsequent to pipe installation, backfilling of wetland trenches will take place immediately, or as approved by EI. The Contractor will restore wetlands as near as practicable to pre-construction conditions and will make a reasonable attempt to return the subsoil to its pre-construction density. During backfilling of wetland areas, subsoil material removed from the trench during construction will be replaced so that the material is not mounded above the adjacent ground surface (undisturbed trench wall). Subsoil that exceeds the elevation of the ground adjacent to the trench will be removed from the wetland and disposed of in an upland area or an EPND-

approved disposal site. After the trench has been backfilled with subsoil, previously segregated topsoil will be spread over the trench area and mounded.

3.9 ROUGH GRADING, CLEANUP, AND TEMPORARY RESTORATION

Cleanup and rough grading activities may take place simultaneously. Cleanup typically involves removing construction debris and replacing fences removed during construction. Rough grading includes restoring original conditions within the disturbed areas (i.e., ditch line, spoil storage areas, and equipment travel lane) and installing or repairing temporary ECDs. Temporary slope breakers will be installed near the boundary between the wetland and adjacent sloped approaches, to prevent sediment flow into the wetland.

3.9.1 Timing

Cleanup and rough grading (including installation of temporary erosion control measures) will begin as soon as practical after the trench is backfilled, weather permitting.

3.9.2 Temporary Stabilization

Where necessary, disturbed wetland areas will be seeded with oats (40 lbs/acre) and/or a temporary seed mix, unless standing water is prevalent or unless permanent planting or seeding with native wetland vegetation is required by applicable permits. No fertilizer, lime, or mulch will be applied in wetlands.

4.0 HIGHWAY, ROAD AND RAIL CROSSINGS

4.1 ADDITIONAL WORKSPACE

Additional workspaces for bored road and railroad crossings and open-cut road crossings will be determined on a site-specific basis. These workspaces will be adjacent to the road or railroad and limited to the size needed to contain spoil from the crossing.

4.2 MAINTENANCE

Roadway crossings will be maintained in a condition that will prevent tracking of mud onto the roadway.

Rock tracking pads, constructed of stone as required by the applicable permits, will be installed adjacent to paved public roads to prevent or minimize the tracking of soil onto the roadway. If the roadside ditch is part of a jurisdictional waterway, a permit will be obtained prior to installing the tracking pad or culvert. If permitted in wetlands, tracking pads will be limited in size to reduce impacts. Tracking pads installed in wetlands will be constructed with clean rock placed on geotextile fabric, as approved by an EI and with approval from applicable regulatory agencies. All rock and fabric will be removed from the wetland during cleanup.

4.3 TEMPORARY EROSION AND SEDIMENT CONTROLS

Temporary ECDs (e.g., silt fence and/or double-staked straw bales) will be installed on sloped approaches to road crossings where vegetation has been disturbed (refer to Figure 25).

5.0 CONSTRUCTION DEWATERING

5.1 TRENCH DEWATERING

Prior to initiating dewatering activities, the EI will approve the water discharge situation to ensure that the best management practices are applied in such a way as to minimize the potential for scour and water containing sediment from reaching a wetland or waterbody. Furthermore, landowner approval is required in advance of placement of dewatering structures outside of the approved construction ROW. The Contractor will assess each water discharge situation to include:

- **Water Discharge Setting** - This includes:
 - Soil Type - The soil type the discharged water would flow over. The management of discharged water traveling over sandy soil is more likely to soak into the ground as compared to clay soils.
 - Ground Surface - The topography in the area that would influence the surface flow of the discharged water.
 - Adjustable Discharge rate - The flow rate of the discharged water (which may need to vary) can be managed based on the site conditions to minimize instances of water from reaching a sensitive resource area such as a wetland or waterbody. (Example - Water discharged at 500 gallons per minute may soak into the ground while if discharged at a higher flow rate would cause water to flow via overland runoff into a sensitive resource area)
 - Discharge Outfall - The amount of hose and number/size of pumps needed to attempt to discharge water at a location which drains away from waterbodies or wetlands.
- **Pump Intake** - Use floating suction hose or other similar measures to prevent sediment from being sucked from bottom of trench.
- **Overwhelming Existing Drainage** - If the discharge (assumed to be clean) enters a stream, the flow added to the stream will not exceed 50 percent of the peak storm event flow (to prevent adding high water volumes to a small stream channel that causes erosion due to imposing high flow conditions on the stream).
- **Filtering Mechanism** – All dewatering discharges will be directed through a filtering device as indicated below.
 - Well-Vegetated Upland Area – Water can be directed to a well-vegetated upland area through a geotextile filter bag. Geotextile bags need to be sized appropriately for the discharge flow and suspended sediment particle size.
 - Straw Bale Dewatering Structure – Where the dewatering discharge point cannot be located in an upland area due to site conditions and/or distance, the discharge should be directed into a straw bale dewatering structure. The size of the straw bale dewatering structure is dependent on the maximum water discharge rate (refer to Figure 21). A straw bale dewatering structure should be used in conjunction with a geotextile filter bag to provide additional filtration near sensitive resource areas.

- Alternative dewatering methods - Alternative methods may be approved by EPND on a site-specific basis.

5.1.1 Flow Measurement and Water Sampling

The volume of water discharged from the trench will be recorded as required by the applicable permits. The volume may be determined using a flow meter, or equivalent method, as approved by EPND or specified by applicable permit conditions.

Samples of the water discharged will be sampled if required by tribal permits and/or state-issued discharge permits.

5.1.2 Regulatory Notification and Reporting

EPND will notify and submit reports to appropriate tribal, state and federal agencies as required by all permits/authorizations.

5.2 HYDROSTATIC TEST DISCHARGES

Hydrostatic testing involves filling the new pipeline segments with water acquired in accordance with applicable permits (refer to Section 6.0), raising the internal pressure level, and holding that pressure for a specific period of time per federal DOT specifications. Hydrostatic testing will be done to verify that there are no flaws in the pipe or welds. Pre-built sections may be hydrostatically tested prior to installation using HDD and/or guided bore techniques. Hydrostatic testing will be conducted in accordance with applicable appropriation and discharge permits obtained by EPND. Hydrostatic test waters will not be transferred from one waterbody to another. Chlorinated source water will be used and treated as specified in applicable permits. After the hydrostatic test is complete, the line will be depressurized and the water discharged.

5.2.1 Refueling

The operation and refueling of hydrostatic test equipment will be in accordance with the conditions outlined in Section 10.0.

5.2.2 Siting of Test Manifolds

Hydrostatic test manifolds will be installed where necessary to ensure proper test pressures and incorporates changes due to topography. Where feasible, EPND will incorporate minor adjustments to the test manifold locations to avoid placement in wetlands and riparian areas. However, completely avoiding the placement of a test manifold in a wetland may not always be possible. The Contractor will install appropriate erosion control measures where the EI determines they are necessary.

5.2.3 Water Sampling

Water discharged from hydrostatic tests will be sampled as required by state-issued appropriation or discharge permits. Water volumes and flow rates will be recorded using the form provided in Appendix D.

5.2.4 Best Management Practices

Prior to hydrostatic testing the pipeline, EPND will prepare the pipe by removing accumulated construction debris, mill scale, dirt, and dust using a cleaning pig. The debris will be collected in

a temporary receiver and will be properly disposed off-site of by the Contractor. Upon completion of the cleaning operation, the pipeline will be sealed with the test headers.

Test headers and pigs will be arranged to allow for rinse water to be installed ahead of the fill pigs. Rinse water will be treated and disposed of in accordance with applicable permit conditions.

Following testing, the test section will be depressurized and the water will be discharged to a well-vegetated, upland area with an appropriate dewatering structure such as a geotextile filter bag and/or a hay bale structure that will be lined with geotextile fabric. Direct discharges to surface waters, if allowed by permit, will be directed into an energy dissipation device such as a splash pup.

At no time will the discharge rate exceed the applicable discharge rates specified in state-issued or other discharge permits. In the event no maximum discharge rate is identified, discharges will be monitored and adjusted as necessary to avoid scouring, erosion, or sediment transport from the discharge location.

To minimize the potential for introduction and/or spread of invasive species due to hydrostatic testing activities, EPND will discharge water to the same source location from which it was appropriated. If water is used to test multiple test sections, it will be relayed back to the source water through the pipeline for final discharge. Test water will not be discharged to a waterbody other than the appropriation source, unless coordinated and permitted through the applicable agencies.

5.2.5 Flow Measurement

The total volume of water discharged will be determined with a flow meter (or equivalent), or as required by the applicable state permit. The total volume of water discharged will not exceed the volume specified in the applicable permit.

6.0 WATER APPROPRIATION

6.1 GENERAL

Water may be drawn from local sources, such as lakes, streams, and private or municipal wells for construction activities such as dust control, horizontal directional drilling/guided boring, trench dewatering, and hydrostatic testing. The Project will follow applicable permit conditions for the appropriation of water.

The intake hose will be suspended off of the stream or lake bottom and equipped with a screen, or equivalent device, to prevent fish uptake. During withdrawal, adequate waterbody flow rates and volumes will be maintained to protect aquatic life and allow for downstream uses. The volume and rate of withdrawal will be monitoring to comply with applicable permit conditions.

6.2 WATER SOURCES

Water will only be withdrawn from sources approved by EPND and in accordance with applicable permits. No additives to the water are permitted unless written approval is received from EPND and applicable permits authorize such additives.

If appropriation is scheduled to occur during possible periods of low flow, including frozen conditions, a backup source will be identified.

6.3 FLOW MEASUREMENT

At no time will the withdrawal rate for the water source exceed the rate specified in the applicable permits.

The Contractor will measure the withdrawal rate and total volumes of water appropriated with a flow meter (or equivalent) and provide the data to EPND, as required by the applicable permits.

6.4 WATER SAMPLING

Where required by permit conditions, EPND will sample the water during appropriation. The Contractor will assist EPND in obtaining these samples.

6.5 REGULATORY NOTIFICATION AND REPORTING

EPND will notify appropriate agencies of the time of appropriations if required by the state appropriations permits. EPND will submit reports regarding the volume and quality of the water withdrawn if required by the applicable permits.

7.0 REVEGETATION & MONITORING

This section was developed in conjunction with Natural Resources Conservation Service (NRCS) guidelines. Project-specific permit conditions and landowner requests (with exception to wetlands) for specific seed mixes (as indicated in the Project CLL) take precedence over this section.

7.1 PROJECT SEED SPECIFICATIONS

Seed used will be purchased on a “Pure Live Seed” (PLS) basis for seeding (both temporary and permanent) revegetation areas. Seed tags will identify:

- purity;
- germination;
- date tested;
- total weight and PLS weight;
- weed seed content; and
- seed supplier’s name and business information.

Seed will be used within 12 months of testing as required by applicable state rules and regulations. The seed tags on the seed sacks will also certify that the seed is “Noxious Weed Free”. Seed rates used on the Project will be based on PLS rate, not actual weight basis. Therefore, to determine the correct application rate if not indicated on the seed tag, a correction calculation will be performed based the purity and germination. For example, a seed mix that has a specified 10 pounds PLS per acre, 95 percent germination rate, and is 80 percent pure needs to be applied at the following rate:

$$(95\% \text{ germination} \times 80\% \text{ purity})/100 = 76\% \text{ PLS}$$
$$10 \text{ pounds PLS per acre} / .76\% \text{ PLS} = 13.2 \text{ pounds per acre actual seeding rate}$$

The species components of individual mixes are subject to availability at the time of purchase. Grass species may be substituted with alternative native or non-invasive species that are included in the NRCS guidelines and subject to approval by EPND.

Seed tags will be collected by the contractor and provided to EPND during seeding activities. The tags will be reviewed by the EI prior to installation to ensure that the seed mix complies with EPND’s specifications and that it is being applied to the correct location. If bulk delivery of seed is made, the above information will still be made available to EPND. Off-loading/on-loading of seed will not be performed in a designated wetland area.

Legume seed (if used) will be treated with an inoculant specific to the species and in accordance with the manufacturer’s recommended rate of inoculant appropriate for the seeding method (broadcast, drill, or hydroseeding). When hydroseeding, four times the manufacturer’s recommended rate of inoculant will be used.

7.2 TEMPORARY REVEGETATION

EPND’s temporary seed mix (refer to Appendix C) was developed based on recommendations from the NRCS. Unless specifically requested by landowners or land managing agencies, EPND does not intend to establish temporary vegetation in actively cultivated land, standing water wetlands, and/or other standing water areas.

7.3 TIMING FOR TEMPORARY VEGETATION

Temporary revegetation will be established in construction work areas where 14 days or more will elapse between:

- the installation of the first pipeline and the second line where two pipelines will be co-constructed and active construction is ongoing;
- the completion of final grading at a site and the establishment of permanent vegetation; and/or,
- where there is a high risk of erosion due to site-specific soil conditions and topography.

EPND may require the Contractor(s) to conduct temporary seeding sooner than 14 days at site-specific locations near sensitive resource areas and/or areas prone to wind/water erosion.

Temporary vegetation should be established at any time between **April 1 and September 1**. Attempts at temporary revegetation after this date should be assessed on a site-specific basis and with approval from EPND.

7.4 MULCH

Mulch (weed-free straw, wood fiber hydromulch, or a functional equivalent) will be applied to disturbed areas (except for actively cultivated land and wetlands) if requested by the landowner or land managing agency, if specified by the applicable permits or licenses, or as required by EPND. Mulch will specifically be required on:

- Slopes greater than 5 percent; and
- Dry, sandy areas that can blow or wash away (field decision).

Mulch will be free of noxious weeds as listed in applicable state laws. Certified weed-free mulch may also be required at site-specific locations. The Contractor will be responsible for identifying and acquiring sources of weed-free and certified weed-free mulch. Sources will be approved by EPND prior to purchase.

Mulch will be applied at a rate of 2 tons per acre to cover at least 75 percent of the ground surface unless otherwise stipulated by permit conditions. Mulch will be uniformly distributed by a mechanical mulch blower, or by hand in areas not accessible to the mulch blower. Mulch will be anchored/crimped using a mulch-anchoring tool or disc set in the straight position to minimize loss by wind and water, as site conditions allow. In areas not accessible to a mulch-anchoring tool or too steep for safe operation, the mulch may be anchored by liquid tackifiers, with advance written approval from EPND. The manufacturer's recommended method and rate of application will be followed.

Hydro-mulch and liquid tackifier can be used in place of straw or weed-free hay mulch with prior approval from EPND. All hydromulch and liquid tackifier products used will be on the applicable state DOT product list. Application rates will be at the manufacturer's recommended rate, equal to or greater than 2 tons per acre of straw mulch.

7.5 PERMANENT REVEGETATION

Permanent vegetation will be established in areas disturbed within the construction work area (permanent easement, TWS, and ATWS) except in actively cultivated areas and standing water wetlands. The seed mixes for permanent seeding include native seed varieties commonly

found and/or available from local seed distributors. EPND's seed mixes (refer to Appendix C) were selected to augment revegetation via natural recruitment from native seed stock in the topsoil and are not intended to change the natural species composition. Rates provided are assumed for a drill application and will be adjusted as discussed in Section 7.1.

7.6 UPLAND CONSTRUCTION AREAS

In consulting with the NRCS and other agencies, EPND developed a standard upland seed mix for restoring disturbed areas affected by the Project (Appendix C, Table 2). The mix includes species that will provide for effective erosion control and revegetation of the Project area. This seed mix will be used by EPND as the standard upland mix unless an alternate seed mix is specified by landowners or land managing agencies.

7.7 PERMANENT SEEDING OF WETLAND AREAS

7.7.1 Unsaturated Wetland Areas

Non-standing water wetlands will be seeded with the mix provided in Appendix C, Table 3 to provide temporary cover and allowed to revegetate naturally. The natural revegetation process will be encouraged by the seeds and rhizomes in the topsoil spread back over the right-of-way after pipe installation. No fertilizer, lime, or mulch will be applied in wetlands.

7.7.2 Saturated/Standing Water Wetlands

EPND does not propose to seed standing water wetland areas. It is widely accepted that the reestablishment of vegetation within standing water wetlands occurs best through natural process without supplemental seeding.

7.7.3 Forested Wetland Restoration

EPND proposes to allow natural reforestation of the temporary workspace area within forested wetlands via stump sprouting, root sprouting, and natural recruitment. Specific forested wetland restoration provisions will be followed as indicated in applicable permits issued for the Project.

7.8 PERMANENT SEEDING OF WATERBODY BANKS

EPND will reestablish stream bank vegetation using the Upland seed mix listed in Appendix C, Table 2, unless an alternate seed mix is requested by applicable agencies. Additional vegetation requirements may also be contained within Project specific permits. Where a waterbody is located within a wetland, the Contractor will re-seed the banks with the applicable wetland seed mix.

7.9 SPECIALIZED SEED MIXES

The following specialized seed mixes are available upon landowner request on a site-specific basis.

- Residential Areas: This seed mix will be used to reestablish residential lawns or other types of "turf-type" land cover.
- Pasture Areas: This seed mix will be used to reestablish active pastures and hayfields.
- Wildlife Areas: This seed mix will be used to provide a desirable food source for wildlife, specifically deer.

- Native Areas: In consultation with the NRCS, a native seed mix was also developed for restoring areas currently dominated by native plant species. The mix includes naturally occurring species and provide for effective erosion control and revegetation of the Project area. This seed mix will be used by EPND at locations identified as high quality vegetation areas unless an alternate seed mix is specified by landowners or regulatory agencies.
- Roadways: This seed mix will be used to reestablish vegetation within upland areas of roadway easements.

7.10 CONSERVATION RESERVE PROGRAM (CRP) PROPERTIES

EPND's Land Agents will contact landowners where the construction ROW crosses land enrolled in CRP. EPND will work with the respective landowners to identify the parcel-specific CRP seed mixes. CRP lands will be seeded at the direction of the landowner per the site-specific landowner CRP requirements for that parcel and no non-CRP approved seed mix will be planted on CRP lands. CRP parcels will also be seeded with EPND's temporary cover seed mix. Seed for CRP seeding will meet the same criteria as other seed described in Section 7.1

7.11 SEED BED PREPARATION AND SEEDING PROCEDURES

After final grading, deep tillage will be performed in actively cultivated areas and in non-agricultural areas (as directed by EPND) to relieve soil compaction and promote root penetration. Deep tillage will not be conducted in non-farmed wetlands. The soil will then be tilled with a disc, field cultivator, or chisel plow (or equivalent) to prepare a seedbed, breaking up large clods and firm the soil surface. Tillage and equipment operations related to seeding and mulching will be performed parallel to ground contours as much as practicable. Fertilizer and other soil amendments will be incorporated into the soil during seedbed preparation as specified by EPND in the Project-specific CLL requirements and permits. No soil amendments will be applied in wetlands unless directed by the appropriate agencies.

7.12 SEEDING METHODS

Seed will be applied uniformly at specified rates across the prepared construction ROW by drilling, broadcasting, or hydroseeding. The EI will suspend seeding activities if conditions are such that equipment will cause rutting of the surface in the designated seeding areas. EPND will continue to monitor ROW conditions to resume seeding activities as site conditions improve and according to the general seeding timing restrictions listed in Section 7.14.

7.12.1 Drill Seeding

Seeding equipment will be capable of uniformly distributing the seed and sowing it at the required depth. Drills will be equipped with a feeding mechanism that will provide a uniform flow of seed at the desired application rate. Double-disc furrow openers equipped with depth bands and packer wheels to firm the soil over the seed will be used where practicable.

7.12.2 Broadcast Seeding

Broadcast seeding rate will be double the drill-seeding rate. Seed will be uniformly distributed by a mechanical or hand operated seeder. Following seeding, a cultipacker, harrow, or hand rake will be used to cover the seeds and firm the seedbed as is appropriate for the area.

7.12.3 Hydroseeding

Hydroseeding rate will be double the drill seeding rate, or the same as broadcast seeding rate. Seed will be applied alone or in a seed, fertilizer, and/or hydromulch slurry. If seeding is applied alone, the amount of hydromulch material will be adjusted to the seed slurry to show where seeding has taken place, providing a means to identify uniform cover of the construction ROW. Hydroseeders will provide continuous agitation and be capable of supplying a continuous, non-fluctuating flow of slurry. EPND will pre-approve all hydromulch products, which must be on the applicable state DOT product list.

7.13 SOIL AMENDMENTS

EPND will consult with NRCS representatives and review county soil survey information to assess where soil amendments, specifically the application of fertilizer or lime are needed to promote successful revegetation. No fertilizer or lime will be added with native seed mixes. When using non-native species on dry, dry-mesic and mesic sites for permanent seeding a minimum of 150 pounds of 20-10-10, and 2 tons of 80-85 lime or equivalent will be applied, unless otherwise specified or restricted by the landowner, NRCS, or land-managing agency. Soil amendments may be applied to agricultural, pasture, and/or residential lands if requested by landowners and/or land managing agencies. EPND will apply phosphate free fertilizers to areas within 100 feet of a waterway if soil amendments are required.

7.14 SEEDING PERIODS

These seeding windows have been developed in consultation with the NRCS and local/regional seed suppliers for normal average growing seasons, in conjunction with normal climate and soils conditions for maximum seed germination.

Seeding Periods

Native Mixes	
Spring Permanent Seeding	Fall Dormant Seeding
April 1 to June 15	Soil temperature below 55 degrees Fahrenheit

EPND will delay seeding during frozen ground conditions until the applicable spring seeding period or will complete dormant seeding where conditions allow (i.e., no snow cover). EPND will install temporary erosion controls during frozen conditions.

7.15 TIMING OF FINAL SEEDING

Upon final grading of the construction ROW, and upon the restoration of wetland and waterways, seeding and restoration/stabilization will occur within 48 hours. Other methods of stabilization will be used if temporary seeding is not appropriate due to seasonal conditions (e.g., mulch, erosion control matting).

7.16 EROSION & SEDIMENT CONTROL

Erosion control blankets, such as sewn straw mats, jute mats, coconut erosion control blankets, or biodegradable synthetic erosion control blankets, as approved by EPND, will be used on slopes over 30 percent, on stream banks and ditch banks and as directed by EPND.

7.17 DORMANT SEEDING

Dormant seeding is a method used after soil temperatures have cooled to 55 degrees Fahrenheit or cooler to prevent seed germination. Dormant seeding is only practicable if the soil is not frozen and snow is not present. Procedures for applying soil amendments, seedbed preparation, seeding, and mulching are the same as outlined for permanent revegetation in this section.

Where dormant seeding is conducted, one or more of the following temporary erosion and sediment controls will be put in place over the freshly seeded area unless the local soil conservation authority, landowner, or land managing agency specifies otherwise. The temporary measures will be in place within 48 hours of seeding, and are as follows:

- noxious weed-free straw mulch, at not more than 2 tons/acre, anchored;
- hydromulch, at 2 tons/acre, anchored; and/or
- erosion control blanket.

Additional erosion control measures will be applied as requested by the EI.

7.18 MONITORING

EPND will monitor and address all areas where stabilization techniques have been implemented in accordance with conditions identified in the applicable Project permits and/or licenses.

8.0 WINTER CONSTRUCTION

Frozen conditions can preclude effective topsoil segregation. When soil is frozen to a depth greater than the depth of topsoil, the soil will come off in thick slabs that contain both topsoil and subsoil, and mixing can result. If topsoiling will proceed under these conditions, it should be done at the excavation only. A ripper should be used to break up the frozen topsoil over the trench line only. Care should be taken to only rip to the actual depth of topsoil or to a maximum depth of 12 inches, whichever is less. Topsoil in the spoil storage area should be graded smooth to minimize mixing during backfilling. Sufficient time is needed to allow the newly graded topsoil to freeze in place prior to trenching.

Summer construction of large diameter pipelines in saturated/standing water wetlands with unconsolidated soils can be difficult and potentially result in greater wetland disturbance including wider trench widths and extensive rutting/surface disturbance. Constructing across these types of wetlands in the winter can result in fewer impacts. Heavy construction equipment use and travel along the construction ROW, which may not be possible in summer conditions due to saturated, unstable soil conditions, can be accomplished in the winter by establishing temporary winter frost/ice roads. These frost/ice roads protect underlying vegetation and upper layers of wetland surfaces from disturbance potentially created during summer construction.

The area of open excavation will be minimized during winter construction to reduce amount of frozen backfill, and facilitate restoration to pre-construction contours. If winter conditions preclude final grading and cleanup, the Contractor will stabilize the area and temporary erosion control measures will remain in place until permanent erosion control measures are installed. Depending on site and weather conditions, EPND may require the Contractor to install dormant seeding, mulching, and/or installation of erosion control blanket on stream banks or other sensitive locations.

9.0 WASTE MANAGEMENT

The Contractor will properly handle, store, and dispose of all solid and hazardous materials and wastes that are used or generated by the Contractor as a result of the Project. The Contractor will determine if the materials and wastes associated with the Project classify as hazardous materials and/or wastes in accordance with applicable federal and/or state criteria. Upon request by EPND, the Contractor will provide documentation to EPND to substantiate findings of the regulatory status of materials and/or wastes used and/or generated as a result of the Project.

The Contractor will collect all waste materials, including oil or other waste liquids generated as a result of equipment maintenance, daily in suitable or approved containers (i.e., labeled and meeting any relevant regulatory requirements). On a routine basis, the Contractor will remove the containers of waste from the site and properly dispose of them. Throughout the duration of the Project, the Contractor will cleanup areas to the satisfaction of EPND. The Contractor is responsible for proper off-site disposal of all wastes generated during the Project. No wastes are to be left on EPND property, along the ROW, or buried in an excavation or otherwise disposed of on EPND property or ROW.

9.1 HAZARDOUS WASTES

If a Contractor generates a hazardous waste from materials they have brought on-site (e.g., paint clean-up solvents, waste paints, etc.), then the Contractor is responsible for proper waste collection, storage and disposal in accordance with all applicable regulations. The Contractor remains responsible for the proper handling, storage and disposal of the hazardous waste. Any release of the hazardous waste as a result of the improper handling, storage or disposal by the Contractor in this instance is the responsibility of the Contractor to rectify to the satisfaction of EPND and all applicable regulatory agencies.

9.2 ABRASIVE BLAST DEBRIS

The Contractor will contain and collect spent abrasive blast materials and place it into appropriate containers. The Contractor is responsible for covering the containers with appropriate means of rainwater and stormwater control to prevent said waters from entering or exiting the container. The Contractor is responsible for disposal of the spent abrasive in accordance with applicable federal, state and local regulatory requirements. The Contractor is responsible for determining if the spent abrasive is classified as a “hazardous” or “special” waste as defined by applicable federal and state regulations. If the spent abrasive is determined to be hazardous waste as a direct result of constituents of an EPND facility or equipment, EPND will coordinate proper disposal with the Contractor as previously discussed.

10.0 SPILL PREVENTION, CONTAINMENT, AND CONTROL MEASURES

This section describes planning, prevention and control measures to minimize impacts resulting from spills of fuels, petroleum products, or other regulated substances as a result of construction. These measures will be implemented by the Contractor, unless otherwise indicated by EPND.

10.1 PLANNING AND PREVENTION

EPND requires its Contractors to implement proper planning and preventative measures to minimize the likelihood of spills, and to quickly and successfully clean up a spill should one occur. This section sets forth minimum standards for handling and storing regulated substances and cleaning up spills. Potential sources of construction-related spills include machinery and equipment failure, fuel handling, transfer accidents and storage tank leaks. The Contractor will be responsible for implementing, at a minimum, the following planning and prevention measures.

10.2 ROLES AND RESPONSIBILITIES

10.2.1 Spill Coordinator

A Spill Coordinator will be designated by the Contractor, subject to approval by EPND. For all construction related spills, the Spill Coordinator will:

- report all spills to the EPND Representative immediately;
- report spills to appropriate federal, state and local agencies as soon as possible (subject to EI verification);
- mobilize on-site personnel, equipment, and materials for containment and/or cleanup commensurate with the extent of the spill;
- assist the Emergency Response Contractor (refer to a list of potential contractors provided in Appendix E) and monitor containment procedures to ensure that the actions are consistent with the requirements of this section;
- in consultation with EPND and appropriate agencies, determine when it is necessary to evacuate spill sites to safeguard human health;
- in consultation with EPND, coordinate with appropriate agencies the need to contact additional parties or agencies; and
- complete a Spill Report Form (refer to Appendix F) within 24-hours of the occurrence of a spill, regardless of the size of the spill.

10.2.2 Environmental Inspector

The EI will monitor the Contractor's compliance with the provisions of this section to ensure that appropriate agency notifications are made, spill resources are allocated, and clean-up is accomplished in accordance with applicable agency requirements

10.2.3 Authorized Personnel

Authorized Personnel are representatives of the Contractor who are designated to handle fuel, lubricants or other regulated substances. Authorized Personnel will be familiar with the requirements of this section and the consequences of non-compliance.

10.2.4 Construction Superintendent

The Contractor's Construction Superintendent or representative will notify the EI immediately of any spill of a petroleum product or hazardous liquid, regardless of volume.

10.2.5 Construction Personnel

Construction Personnel are representatives of the Contractor involved with the installation of the pipeline. Construction Personnel will notify the crew foreman or Spill Coordinator immediately of any spill of a petroleum product or hazardous liquid, regardless of volume.

10.3 TRAINING

The Contractor will train all employees handling fuels and other regulated substances to follow spill prevention procedures. The Contractor will train all employees who handle fuels and other regulated substances to prevent spills and to quickly and effectively contain and clean up spills that may occur in accordance with applicable regulations. .

10.4 EQUIPMENT

- Each construction crew will have adequate absorbent materials and containment booms on hand, to enable the rapid cleanup of any spill which may occur.
- The Contractor will maintain spill kits containing a sufficient quantity of absorbent and barrier materials to adequately contain and recover foreseeable spills. These kits may include, but are not limited to absorbent pads, straw bales, absorbent clay, sawdust, floor-drying agents, spill containment barriers, plastic sheeting, skimmer pumps, and holding tanks. This equipment will be located near fuel storage areas and other locations as necessary to be readily available to control foreseeable spills.
- Suitable plastic lining materials will be available for placement below and on top of temporarily-stored contaminated soils and materials.
- All fueling vehicles, and where necessary, service vehicles, will carry materials adequate to control foreseeable spills. Such material may include but not be limited to absorbent pads, commercial absorbent material, plastic bags with ties, and shovels.
- The Spill Coordinator will inform the Authorized Personnel, Construction Personnel, and the EIs of the locations of spill control equipment and materials, and have them readily accessible during construction activity. Spill kits should be clearly labeled for quick and easy identification in the field.
- All fuel nozzles will be equipped with functional automatic shut-offs.
- Fuel trucks transporting fuel to on-site construction equipment will travel only on approved access roads.

10.5 SUPERVISION AND INSPECTION

The Contractor will perform a pre-construction inspection and test of all equipment to ensure that it is in good repair. During construction, the Contractor will regularly inspect hoses, pipes, valves, and tanks to ensure equipment is free of leaks. Any equipment that found to be leaking or in need of repair will be immediately removed from service by Contractor and repaired, prior to resuming work.

10.6 STORAGE AND HANDLING OF FUELS/HAZARDOUS LIQUIDS

10.6.1 Fuel Storage - General

The Contractor will follow proper fuel storage practices, including, but not limited to the following:

- Fuel storage will be at Contractor yards only or as approved by EPND.
- Proper signage at and adjacent to fuel storage areas to include “Fuel Storage Area – No smoking within 50 feet.”
- Tools and materials to stop the flow of leaking will be kept on-site. Such equipment may include, but not be limited to, plugs of various sizes, 3M tank patches, a hammer, assorted sizes of metal screws with rubber washers, a screwdriver, and plastic tape.
- Fuels, lubricants, waste oil, and any other regulated substances will be stored in aboveground tanks only.
- Storage tanks and containers will conform to all applicable industry codes (NFPA, UFC, etc.).
- A suitable secondary containment structure will be utilized at each fuel storage site. These structures will be lined with suitable plastic sheeting; provide a minimum containment volume equal to 150 percent of the volume of the largest storage vessel..
- Secondary containment areas will not have drains. Precipitation may be drawn off as necessary. If visual inspection indicates that no spillage has occurred in the secondary containment structure, accumulated water may be drawn off and discharged in accordance with Section 5.0. If spillage has occurred in the structure, accumulated waste will be drawn off and pumped into drum storage for disposal.

10.6.2 Refueling

Contractor will make all efforts to dispense fuel by Authorized Personnel during daylight hours. Fuel dispensing operations will be attended by Authorized Personnel at all times. Personnel will be stationed at both ends of the hose during fueling unless both ends are visible and are readily accessible by one person.

10.6.3 Refueling, Maintenance, and Fuel Storage Near Wetlands and Waterbodies

EPND requires that the storage of petroleum products, refueling, maintenance, and lubricating operations take place in upland areas that are more than 100 feet from wetlands, streams, and waterbodies (including drainage ditches), and water supply wells. In addition, the Contractor will

store hazardous materials, chemicals, fuel and lubricating oils, and perform concrete coating activities outside these areas.

In certain instances, refueling or fuel storage may be unavoidable due to site-specific conditions or unique construction requirements (e.g. continuously operating pumps or equipment on barges). These locations will be approved in advance by the EI. Site-specific precautions, in addition to those practices described above, will be taken when refueling or maintenance activities are required within 100 feet of streams, wetlands or other waterbodies. These precautions include, but are not limited to:

- Adequate amounts of absorbent materials and containment booms will be kept on hand by each construction crew to enable the rapid cleanup of any spill which may occur;
- If fuel will be stored within wetlands or near streams for refueling of continuously operating pumps, secondary containment will be used;
- Secondary containment structures will be lined with suitable plastic sheeting, provide a containment volume of at least 150 percent of the storage vessel, and allow for at least one foot of freeboard; and
- Provide adequate lighting for these locations and activities.

10.6.4 Overnight parking

Overnight parking of equipment (including but not limited to light plants, generators, pumps, and machinery) is not allowed within 100 feet of a wetland or waterbody unless special containment provisions have been implemented and approved by the EI in advance.

10.6.5 Concrete Washout Handling

Concrete wash water, grindings and slurry, will not be discharged to wetlands, waterbodies, and storm sewer systems or allowed to drain onto adjacent properties. Wash water disposal will be limited to a defined area of the site or to an area designated for cement washout. The area(s) will be sufficient to contain the wash water and residual cement. Contractors hired to provide concrete products will provide equipment capable of reclaiming wash water during wash out.

10.7 INITIAL SPILL MANAGEMENT

10.7.1 Immediate Response

Immediately upon learning of any fuel, oil, hazardous material or other regulated substance spill, or upon learning of conditions that will lead to an imminent spill, the person discovering the situation will:

- Initiate actions to contain the fluid that has spilled or is about to spill, and initiate action to eliminate the source of the spill to the maximum extent that is safely possible.
- Notify the crew foreman and/or the Spill Coordinator and provide them with the following information:
 - Location and cause of the spill;

- The type of material that has spilled; and
- Whether the spill has reached or is likely to reach any surface water.

Upon learning of a spill or a potential spill the Spill Coordinator will:

- Assess the situation and determine the need for further action;
- Direct subsequent activities and/or further assign responsibilities to other personnel; and
- Notify the EI.

10.7.2 Mobilization

The Spill Coordinator will mobilize on-site personnel, equipment, and materials for containment and/or cleanup commensurate with the extent of the spill. If the Spill Coordinator feels that a spill is beyond the scope of on-site equipment and personnel, the Spill Coordinator will immediately notify the Construction Superintendent that an Emergency Response Contractor is needed to contain and/or clean up the spill. Appendix E contains a list of potential Emergency Response Contractors. The Spill Coordinator will assist the Emergency Response Contractor and monitor containment procedures to ensure that the actions are consistent with the requirements of this Section.

In the event of a suspected Enbridge pipeline spill (to an adjacent pipeline), Enbridge's Emergency Pipeline Control Center will be notified at 1-800-858-5253 (24-hours/day), as well as the EPND EI. Actions requiring emergency response will be coordinated by Enbridge.

10.8 SPILL NOTIFICATION RESPONSIBILITIES

10.8.1 Notification Volumes

The Contractor's Construction Superintendent or representative will notify the EPND Representative and the EI immediately of any spill of a petroleum product or hazardous liquid, regardless of volume.

10.8.2 Spill Report Form

The Spill Coordinator will complete a Spill Report Form (Appendix F) for each release of a regulated substance, regardless of volume. The Spill Report Form will be submitted to the EI within 24 hours of the occurrence of a spill. Follow-up written reports, associated laboratory analyses, and other documentation may also be required separately on a site-specific basis as directed by the EI. Documentation is the responsibility of the Contractor.

10.8.3 Agency Notification

The Contractor will report spills to appropriate federal, state and local agencies as soon as possible. A listing of federal, state, and local agencies including reporting thresholds and timeframes is provided in Appendix G.

The Contractor, in coordination with EPND and the appropriate federal, state and local agencies will ensure that additional parties or agencies are properly notified. Additionally, the Contractor is responsible for ensuring that all cleanup activities required by a jurisdictional agency are satisfactorily met and provide documentation to EPND demonstrating this compliance.

10.9 SPILL CONTAINMENT AND CLEANUP

In the event of a spill, the Contractor will abide by all applicable federal, state and local regulations with respect to cleaning up the spill. All clean-up and other construction related spill activities will be completed by, and costs assumed by the Contractor. Specific cleanup measures for both upland and wetland/waterbody spills are described below.

10.9.1 Spill Control - Upland Areas

- If a spill should occur during refueling operations, **STOP** the operation until the spill can be controlled and the situation corrected.
- The source of the spill will be identified and contained immediately.
- For large spills on land, the spill will be contained and pumped immediately into tank trucks. The Contractor or, if necessary, an Emergency Response Contractor, will excavate contaminated soil.
- The spilled material and the contaminated soil will be treated and/or disposed of in accordance with all applicable federal, state, and local agency requirements.
- Smaller spills on land will be cleaned up with absorbent materials. Contaminated soil or other materials associated with these releases will also be collected and disposed of in accordance with applicable regulations.
- Flowing spills will be contained and/or absorbed before reaching surface waters or wetlands.
- Absorbent material(s) will be placed over spills to minimize spreading and to reduce its penetration into the soil.
- The Spill Coordinator, in consultation with the EI and appropriate agencies, determine when spill sites will be evacuated as necessary to safeguard human health. Evacuation parameters will include consideration for the potential of fire, explosion, and hazardous gases.

10.10 SPILL CONTROL - WETLANDS AND WATERBODIES

In addition to the above measures, the following conditions apply if a spill occurs near or into a wetland or waterbody, regardless of size:

- If a spill occurs during refueling operations, **STOP** the operation until the spill can be controlled and the situation corrected.
- The Contractor will use sorbent booms and pads to contain and recover released materials in standing water.
- If necessary, for large spills in waterbodies, The Contractor will secure an Emergency Response Contractor to further contain and clean up the spill.
- The Contractor will excavate contaminated soils in wetlands and temporarily place them on plastic sheeting in a bermed area, a minimum of 100 feet away from the wetland.

Contaminated soils will be covered with plastic sheeting while being stored temporarily and properly disposed of as soon as possible, in accordance with Section 10.11.

10.11 STORAGE AND DISPOSAL OF CONTAMINATED MATERIALS

- Appendix E lists potential treatment and disposal facilities for contaminated materials, petroleum products, and other construction-related wastes. The Contractor should recycle those wastes, such as motor oil, where there is an established recycling program available. Wastes such as grease or oily rags shall be disposed of in accordance with state requirements.
- The Contractor will store and dispose of all contaminated soils, absorbent materials, and other wastes in accordance with all applicable state and federal regulations.
- Only licensed carriers may be used to transport contaminated material from the site to a disposal facility.
- If it is necessary to temporarily store excavated soils on site, these materials will be placed on, and covered by, plastic sheeting, and the storage area bermed to prevent and contain runoff.

11.0 DRILLING FLUID RESPONSE, CONTAINMENT, AND NOTIFICATION PROCEDURES

Construction of a pipeline may include the use of trenchless methods known as the horizontal directional drilling (HDD) and guided/road bore methods. Throughout this section, both methods are referred to collectively as “drilling”. While the HDD method always includes the use of drilling fluid, the guided or road bore method might use drilling fluid or only use water to power and lubricate the bore. The HDD drilling fluids/mud consists primarily of water mixed with inert bentonite clay. Under certain conditions an additive may need to be mixed with the drilling fluids/mud for viscosity or lubricating reasons. Only non-hazardous additives will be used and a Material Safety Data Sheet (MSDS) for the drilling fluid will be maintained on-site.

This section elaborates on measures to be implemented by the Contractor if an inadvertent release of drilling fluid occurs despite prevention efforts. Prior to the commencement of drilling operations, the Contractor will inform construction personnel involved in as to the responsible party(ies) for release containment and response. The Contractor will ensure that the appropriate response personnel and containment equipment are on site for each drill/bore.

11.1 ON-SITE OBSERVATION DURING CONSTRUCTION

During construction of a drilled crossing, Contractor personnel will monitor the pipeline route throughout the process, as follows:

The Contractor will inform construction observers on what to watch for and will make them aware of the importance of timely detection and response actions to any release of drilling fluid.

- Construction observers will have appropriate, operational communication equipment (e.g., radio and cell phones) available at all times during installation of the directionally drilled crossing, with the ability to communicate directly with the HDD operator.
- The HDD operator will monitor the annular drilling fluid pressures during pilot hole operations.
- If the HDD operator realizes a sustained loss in fluid pressure or loss of circulation:
 - The operator will immediately notify the construction observers of the assumed position of the drill tool; and
 - The Contractor will visually monitor the appropriate portion of the drill path where the drill tool is located to determine if an inadvertent return occurred. The Contractor may perform this monitoring by walking or by using a boat, as appropriate.
- Construction observers, EI(s), or the EPND HDD craft inspector have the authority to order installation of containment structures, if needed, and to require additional response measures if deemed appropriate.

11.2 CONTAINMENT, RESPONSE, AND CLEAN-UP EQUIPMENT

Containment, response and clean-up equipment will be available at both sides of an HDD crossing location and one side of a guided or road bore prior to the commencement to assure a timely response in the event of an inadvertent release of drilling fluid. Containment and response equipment includes but is not limited to:

- straw bales and staking
- pre-filled sandbags
- turbidity curtain (not necessary for guided or road bores that do not involve a waterbody)
- silt fence
- plastic sheeting and/or geotextile fabric
- shovels, brooms, buckets, and other appropriate hand tools
- pumps and sufficient hose
- fluid storage tanks (may not be necessary for guided or road bores)
- vacuum truck on 24-hour call
- one small boat (for larger rivers and open water wetlands)
- light plant/generator (only necessary where operations are conducted outside of daylight hours)

11.3 RESPONSE

In the event an inadvertent drilling fluid release is observed, the EI and the Contractor will assess to determine the amount of fluid being released and potential for the release to reach sensitive resource areas (e.g., wetlands and waterbodies). Response measures will vary based on location of inadvertent release as discussed below.

11.3.1 Upland Locations

Response measures include:

- The EI will evaluate the release to determine if containment structures are warranted and if they will effectively contain the release.
- If the amount of the surface release is not great enough to allow the practical physical collection from the affected area, it will be diluted with clean water and/or the fluid will be allowed to dry and dissipate naturally.
- Earthen or sandbag berms, silt fence, and/or hay bales will be installed to contain small releases and prevent migration of drilling fluid.
- The Contractor will remove excess fluid at a rate sufficient to prevent an uncontrolled release.
- If the amount of the surface release exceeds that which can be completely contained with hand-placed barriers, small collection sumps (less than 5 cubic yards) may be used (with approval from EPND) to remove released drilling fluid by the use of portable pumps and hoses.
- The EI will inform the Contractor to initiate immediate suspension of drilling operations if the fluid release cannot be effectively contained.

11.3.2 Wetland and Waterbody Locations

This section also applies to areas immediately adjacent to wetlands and waterbodies, such as stream banks or steep slopes, where drilling fluid releases could quickly reach surface waters.

- In the event of a drilling fluid release in wetlands, waterbodies, or adjacent areas:
 - The EI will evaluate the release, and the Contractor will implement appropriate containment measures.

- The EI and the Contractor will evaluate the recovery measures to determine the most effective collection method.
- EPND Engineering and the Contractor will review and adjust drill pressures, pump volume rates, and drill profile to minimize the extent of the release.
- EPND will suspend drilling operations if containment measures do not effectively control the release.
- If the amount of the surface release exceeds that which can be contained with hand-placed barriers, small collection sumps (less than 5 cubic yards) may be excavated to collect released drilling fluid for removal by the use of portable pumps and hoses.
- If the amount of the surface release is not great enough to allow the practical physical collection from the affected area without causing additional impacts, with approval from both EPND Environmental and Construction Management, it may be diluted with clean water and/or the fluid will be allowed to dry and dissipate naturally.
- Excess fluid will be held within the containment area and removed using pumps or other appropriate measures at a rate sufficient to maintain secure containment.
- Recovered fluid will be stored in a temporary holding tank or other suitable structure out of the floodplain and/or wetland for reuse or eventual disposal in an approved disposal facility
- EPND will consult with the appropriate regulatory agencies to evaluate the circumstances of the release, discuss additional containment or cleanup requirements, and determine whether and under what conditions the HDD may proceed.

11.4 NOTIFICATION AND RESUMPTION OF SUSPENDED HDD OPERATIONS

The Contractor will immediately notify the EI of all drilling fluid releases. If the EI determines the release affects wetland or waterbody areas, he or she will immediately notify EPND Environment and Construction Management and the appropriate regulatory agencies.

If notifications are necessary during non-business hours they will be done according to prior arrangements made between EPND and the regulatory agencies. Follow-up notifications will be made as necessary and practicable.

The conditions under which drilling/boring operations can resume will be discussed with appropriate regulatory agencies and/or field representatives. If containment measures are functioning, and the circumstances and potential impacts of the release are understood, drilling/boring operations will resume.

11.5 CLEAN-UP

The following measures are to be considered as appropriate:

- Drilling fluid will be cleaned up by hand using hand shovels, buckets and soft-bristled brooms as possible without causing extensive ancillary damage to existing vegetation. Clean water washes may also be employed if deemed beneficial and feasible.
- Containment structures will be pumped out and the ground surface scraped to bare topsoil without causing undue loss of topsoil or ancillary damage to existing and adjacent vegetation.

- Material will be collected in containers for temporary storage prior to removal from the site.
- The EI will regularly evaluate the potential for secondary impact from the clean-up process and clean-up activities terminated if physical damage to the site is deemed to exceed the benefits of removal activities. This decision will be made in consultation with the appropriate regulatory agencies and/or EPND.

11.6 RESTORATION AND POST-CONSTRUCTION MONITORING

Following cleanup activities, restoration and revegetation of affected areas will be completed in accordance with all applicable local, state, and federal permits in addition to EPND's EPP. EPND will monitor the release site as appropriate to assure adequate restoration.

Figures

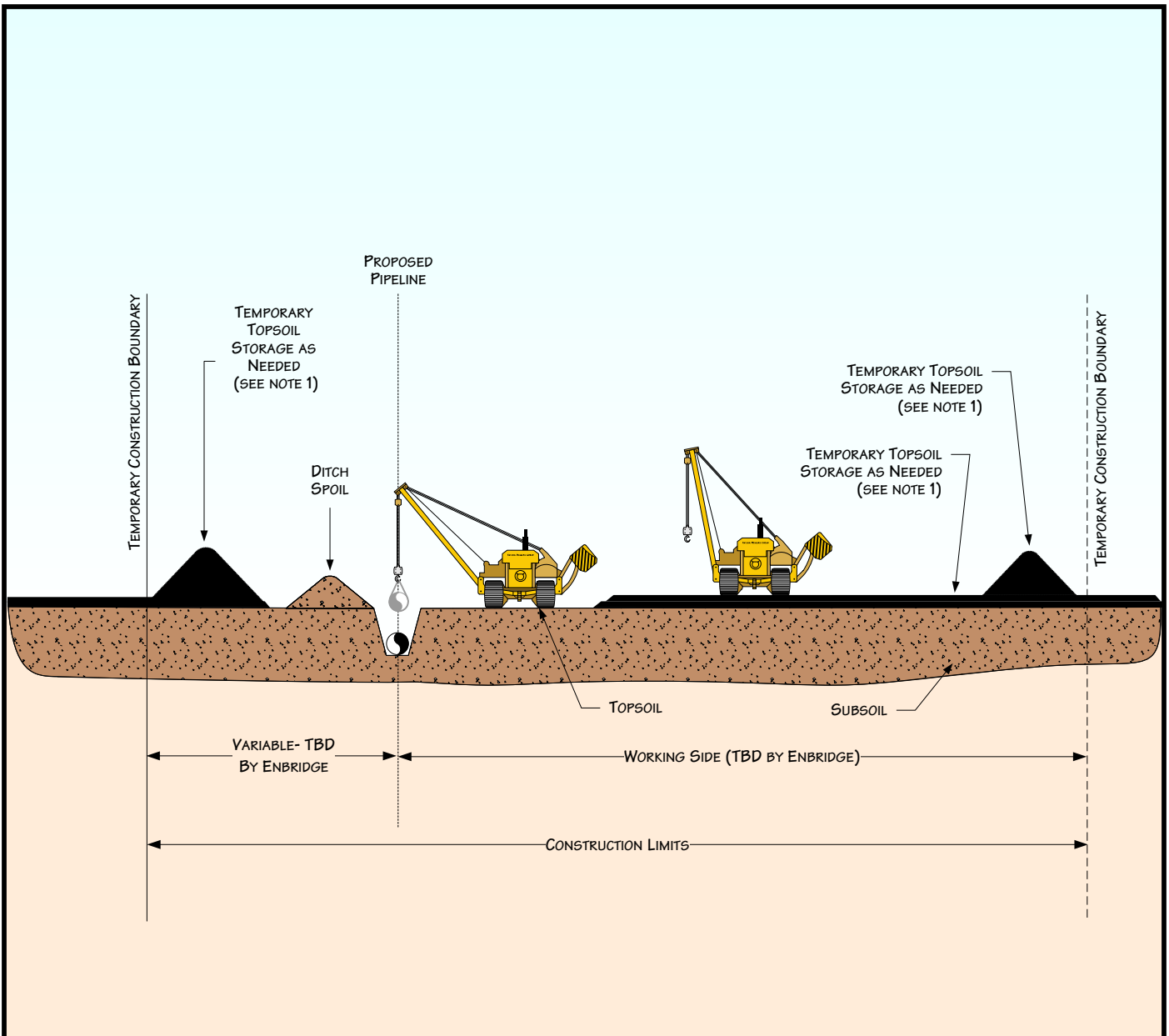

PROFILE

NOTES:

1. STOCKPILE TOPSOIL SEPARATELY FROM DITCH SPOIL AS SHOWN OR IN OTHER CONFIGURATIONS APPROVED BY THE COMPANY.

Environmental Protection Plan



Figure 1
Environmental Protection Plan
 Typical Topsoil Segregation –
 Modified Ditch Plus Spoil Side

DATE: 7/9/2001	
REVISED: 3/11/2011	
SCALE: NTS	
DRAWN BY: JPBOENTJE	
<small>K:_CLIENT_PROJECTS\ID-FIEEL\2011-019\FIG 1-3_TYPICAL_TOPSOIL_SEGREGATION.VSD</small>	

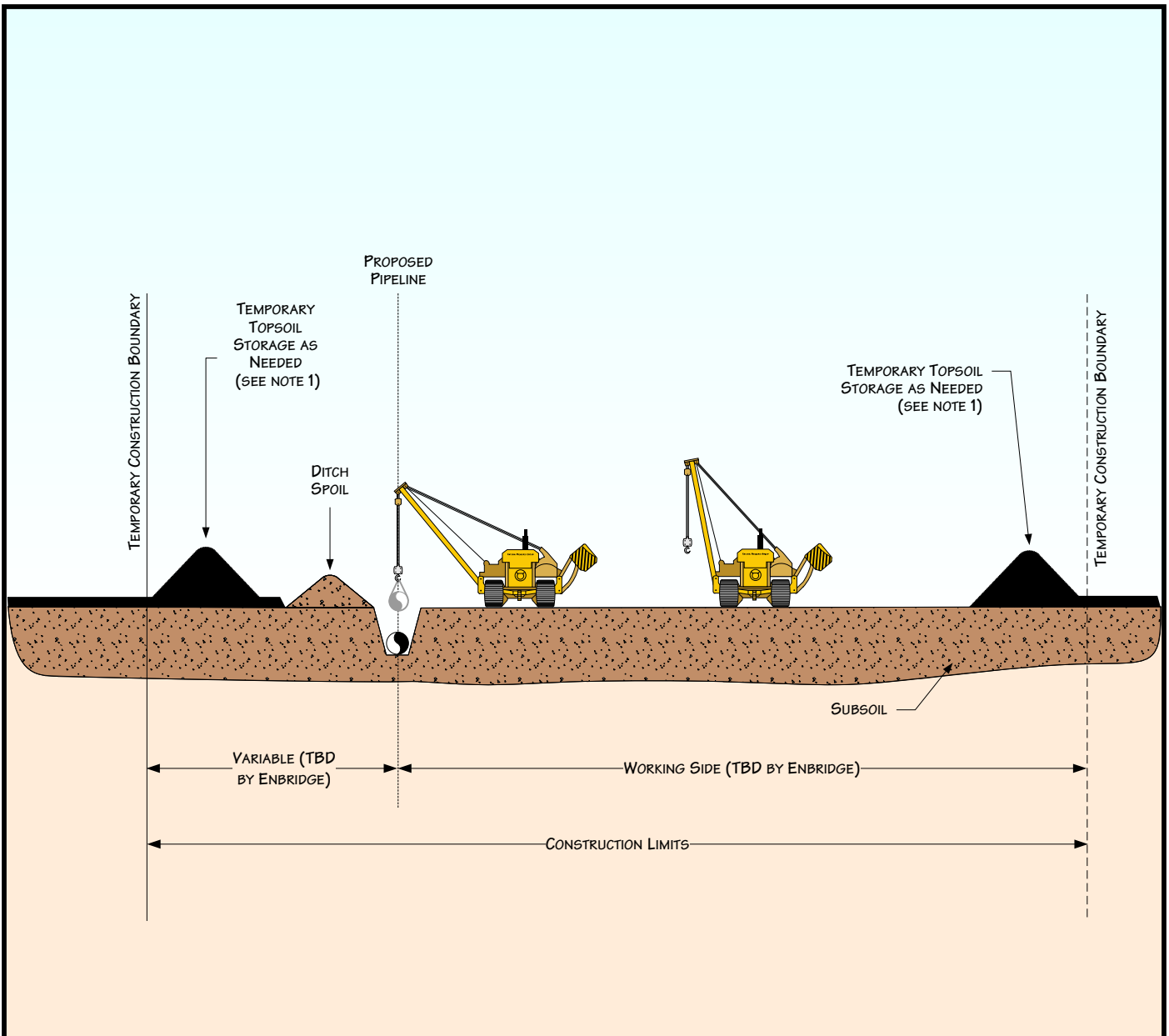

PROFILE

NOTES:

1. STOCKPILE TOPSOIL SEPARATELY FROM DITCH SPOIL AS SHOWN OR IN OTHER CONFIGURATIONS APPROVED BY THE COMPANY.



Figure 2
Environmental Protection Plan
 Typical Topsoil Segregation - Full Right-of-Way

DATE: 7/9/2001	
REVISED: 3/11/2011	
SCALE: NTS	
DRAWN BY: JPBOENTJE	
K:\CLIENT_PROJECTS\ID-FIEEL\2011-019\FIG 1-3_TYPICAL_TOPSOIL_SEGREGATION.VSD	

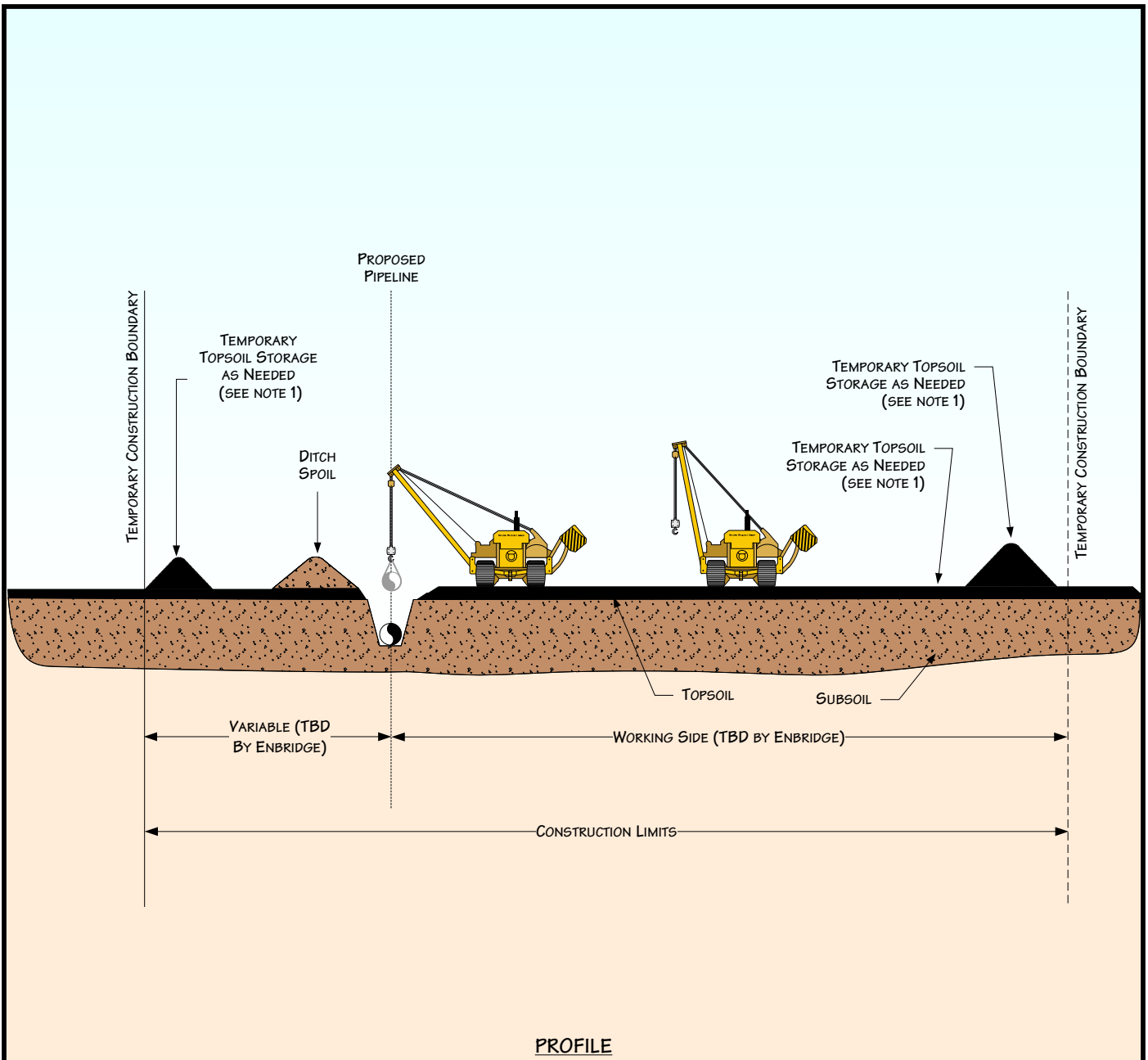

PROFILE

NOTES:

- 1. STOCKPILE TOPSOIL SEPARATELY FROM DITCH SPOIL AS SHOWN OR IN OTHER CONFIGURATIONS APPROVED BY THE COMPANY.



Figure 3
Environmental Protection Plan
 Typical Topsoil Segregation –
 Trench Line Only

DATE: 7/9/2001	
REVISED: 3/11/2011	
SCALE: NTS	
DRAWN BY: JPBOENTJE	
<small>K:\CLIENT_PROJECTS\ID-FIEEL\2011-019\FIG 1-3_TYPICAL_TOPSOIL_SEGREGATION.VSD</small>	

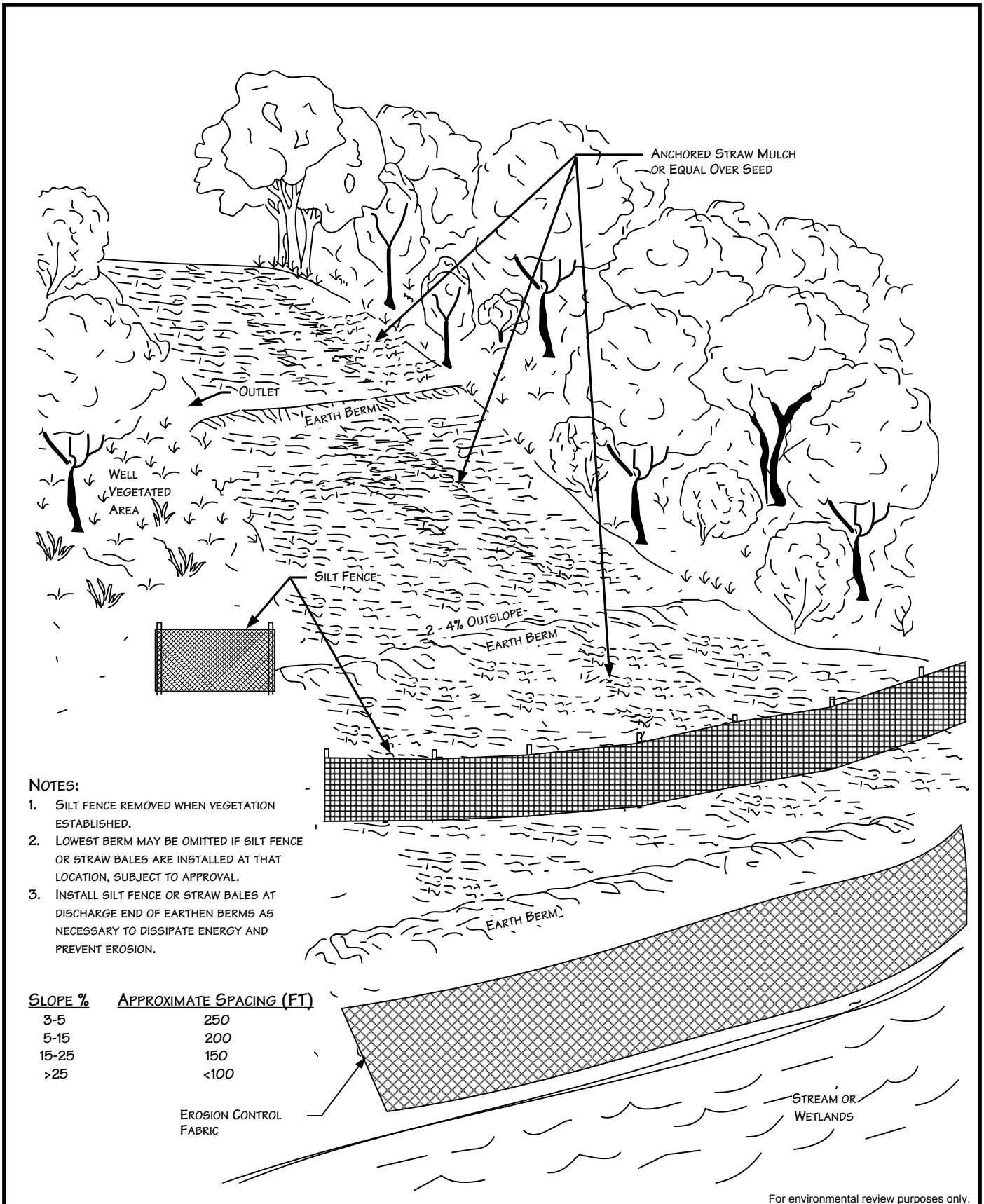

NOTES:

1. SILT FENCE REMOVED WHEN VEGETATION ESTABLISHED.
2. LOWEST BERM MAY BE OMITTED IF SILT FENCE OR STRAW BALES ARE INSTALLED AT THAT LOCATION, SUBJECT TO APPROVAL.
3. INSTALL SILT FENCE OR STRAW BALES AT DISCHARGE END OF EARTHEN BERMS AS NECESSARY TO DISSIPATE ENERGY AND PREVENT EROSION.

SLOPE %	APPROXIMATE SPACING (FT)
3-5	250
5-15	200
15-25	150
>25	<100

For environmental review purposes only.



Figure 4
Environmental Mitigation Plan
 Typical Temporary or Permanent Berms
 Perspective View

DATE: 11/14/2000	
REVISED: 3/11/2011	
SCALE: NTS	
DRAWN BY: KMKENDALL	
<small>K:\ CLIENT PROJECTS\SD-FEEL\2011-019\ FIG_4_BERMS_PERSPECTIVE_VIEW.VSD</small>	

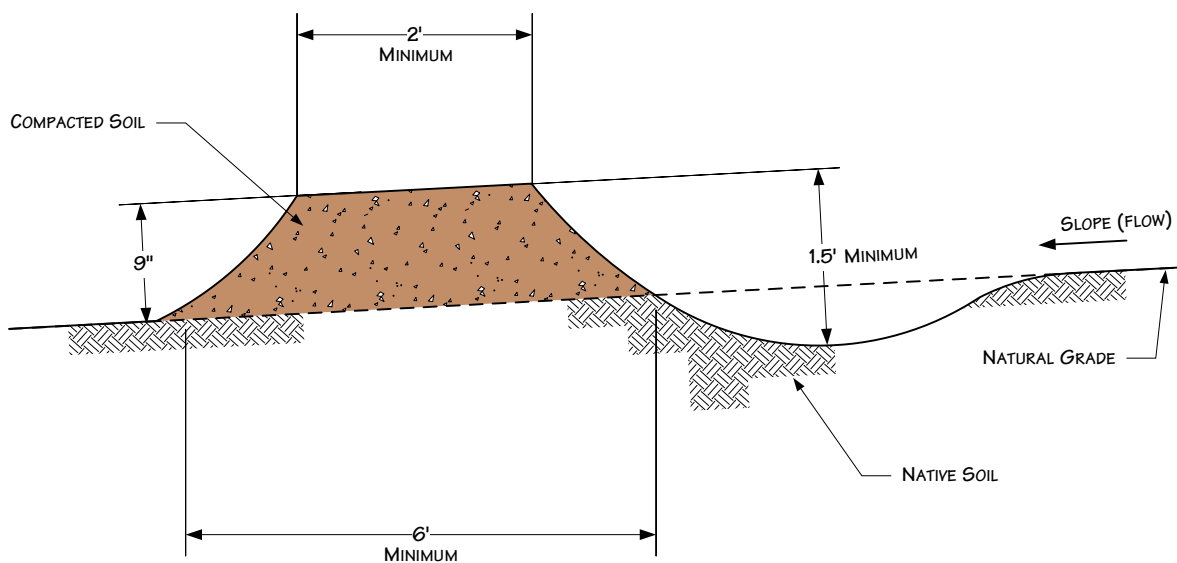

NOTES

1. BERMS SHALL BE CONSTRUCTED WITH 2 TO 4 PERCENT OUTSLOPE.
2. BERMS SHALL BE OUTLETED TO WELL VEGETATED STABLE AREAS, SILT FENCES, STRAW BALES OR ROCK APRONS.
3. BERMS SHALL BE SPACED AS DESCRIBED IN CONSTRUCTION SPECIFICATIONS.
4. ADDITIONAL INFORMATION INCLUDED ON OTHER DRAWINGS.

For environmental review purposes only.



Figure 5
Environmental Protection Plan
 Typical Temporary or Permanent Berms
 Elevation View

DATE: 5/25/2001	
REVISED: 3/11/2011	
SCALE: NTS	
DRAWN BY: KMKENDALL	
<small>K:\ CLIENT PROJECTS\ID-PEEL\2011-019\ FIG_5_BERMS_ELEVATION_VIEW.VSD</small>	

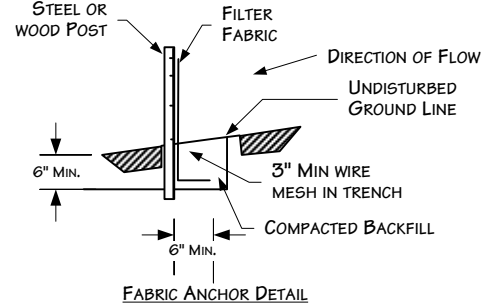
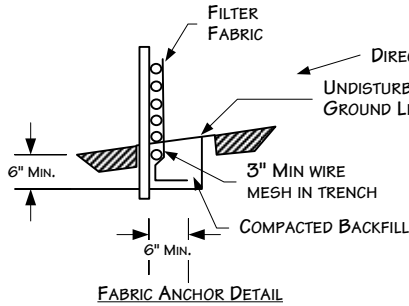
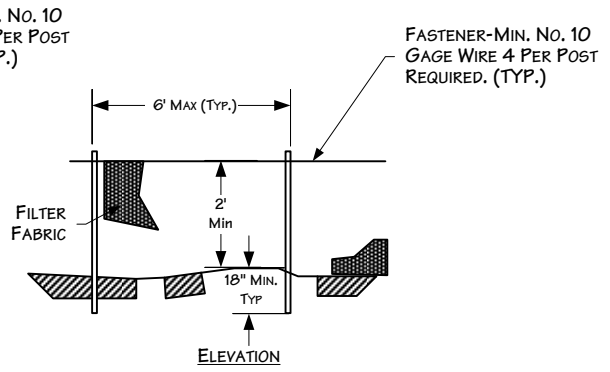
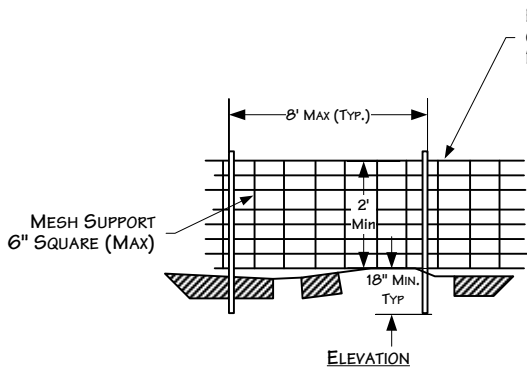

SILT FENCE WITH WIRE SUPPORT PLAN

SILT FENCE PLAN
NTS

NOTES:

1. WIRES OF MESH SUPPORT SHALL BE MIN. GAGE NO. 12.
2. FILTER FABRIC SHALL MEET THE REQUIREMENTS OF THE SPECIFICATION WITH EQUIVALENT OPENING SIZE OF AT LEAST 30 FOR NONWOVEN AND 50 FOR WOVEN. (SIEVE NO.)
3. THE POSTS USED TO SUPPORT THE SILT FENCE SHOULD BE HARDWOOD MATERIAL WITH A MINIMUM CROSS SECTIONAL AREA OF 4 INCHES SQUARE AND 4 FEET LONG. METAL POSTS SHOULD BE USED IN AREAS THAT POND WATER.

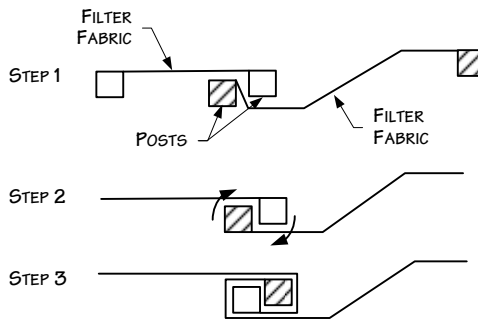

ATTACHING TWO SILT FENCES

NOTES:

1. PLACE THE END POST OF THE SECOND FENCE INSIDE THE END POST OF THE FIRST FENCE.
2. ROTATE BOTH POSTS AT LEAST 180 DEGREES IN A CLOCKWISE DIRECTION TO CREATE A TIGHT SEAL WITH THE FABRIC MATERIAL.
3. DRIVE BOTH POSTS A MINIMUM OF 18 INCHES IN THE GROUND AND BURY THE FLAP.

For environmental review purposes only.



Figure 6
Environmental Protection Plan
Typical Silt Fence Installation

DATE: 5/25/2001

REVISED: 3/23/2011

SCALE: NTS

DRAWN BY: KMKENDALL

K:\CLIENT PROJECTS\ID-PEEL\2011-019\FIG_6_SILT_FENCE_INSTALL.VSD



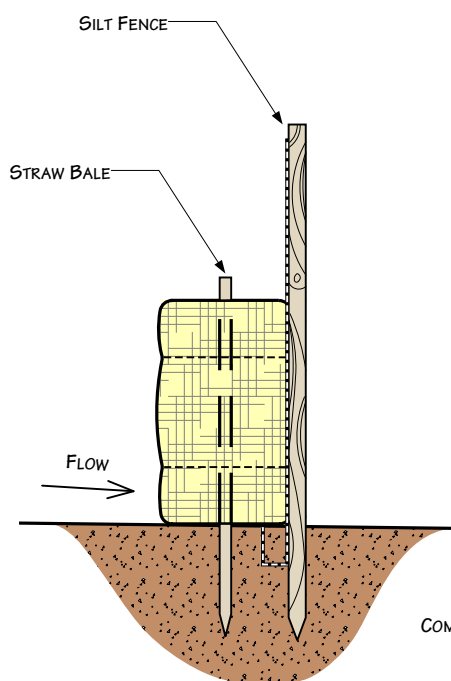
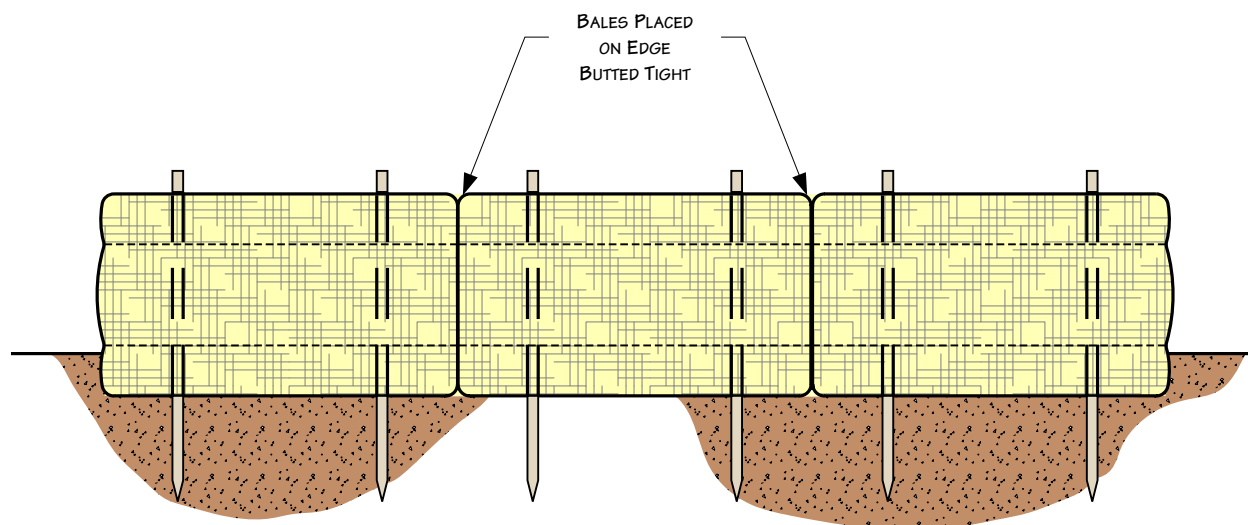

STRAW BALES & SILT FENCE

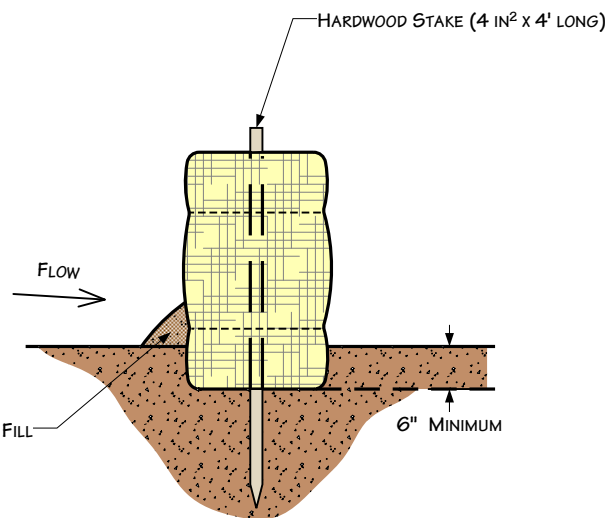

STRAW BALES ONLY

For environmental review purposes only.



Figure 7
Environmental Protection Plan
 Typical Straw Bale Installation

DATE: 5/25/01

REVISED: 3/11/11

SCALE: Not to Scale

DRAWN BY: KMKENDALL

K:\CLIENT PROJECTS\ID-FIEEL\2011-019\FIG_7_STRAW_BALE_INSTALL.VSD



FILL SLOPE SECTION
 EROSION CONTROL BLANKETS SHOULD BE
 INSTALLED VERTICALLY DOWNSLOPE.

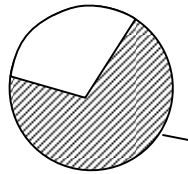

TOE
 MAINTAIN SLOPE ANGLE

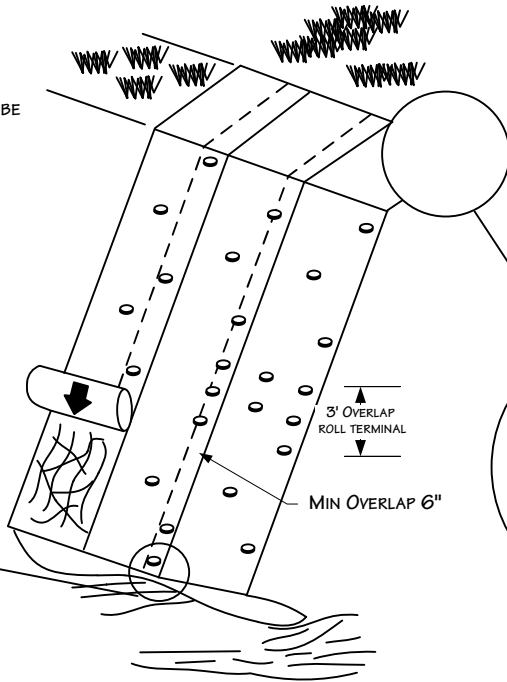

NOTE: SLOPE SURFACE SHALL BE
 SMOOTH AND FREE OF ROCKS,
 LUMPS OF DIRT, GRASS AND STICKS.
 MAT SHALL BE PLACED FLAT ON SURFACE
 TO ENSURE PROPER SOIL CONTACT.

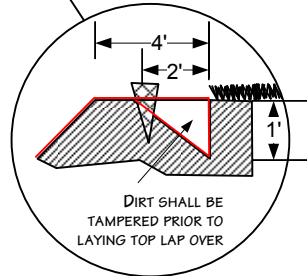

BERM
 TRENCH INTO BERM AND
 PROGRESS DOWNSLOPE

STREAM CHANNEL

EROSION CONTROL BLANKETS SHOULD BE
 INSTALLED HORIZONTALLY WITH STREAM FLOW.

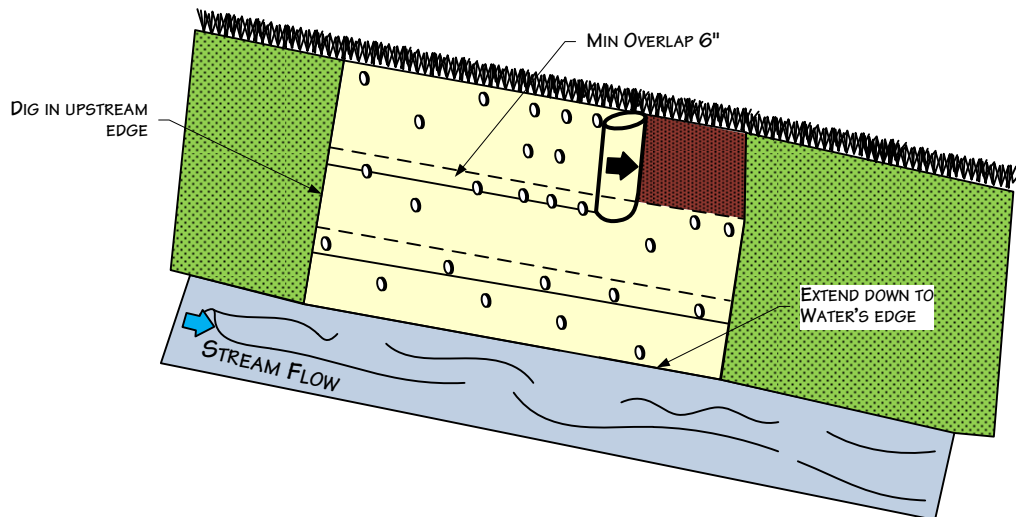

For environmental review purposes only.



Figure 8
 Environmental Protection Plan
 Typical Erosion Control Blanket Installation

DATE: 5/25/2001
 REVISED: 3/23/2011
 SCALE: NTS
 DRAWN BY: KMKENDALL
 K:\CLIENT PROJECTS\ID-FIEEL\2011-019\FIG 8 EROSION_CONTROL_BLANKET_INS TALL.VSD



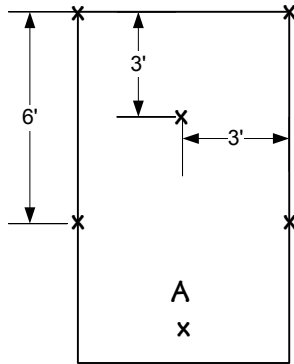

1 STAPLE PER SQ. YD

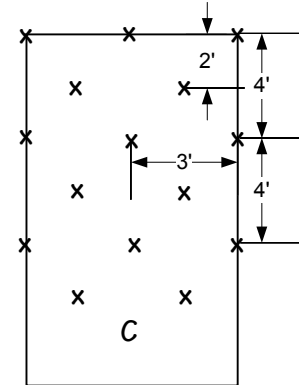

2 STAPLES PER SQ. YD

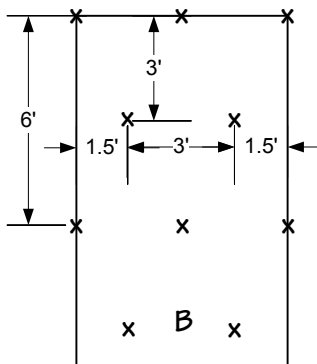
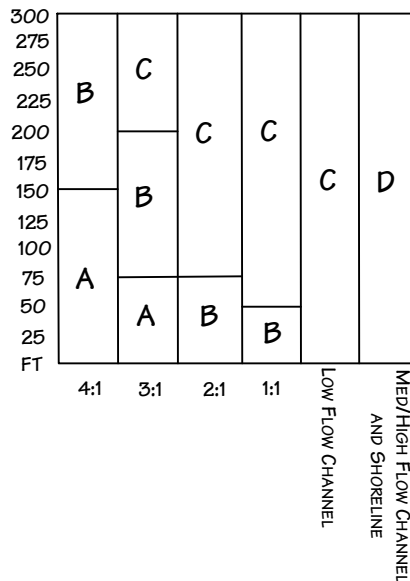

1 1/2 STAPLES PER SQ. YD

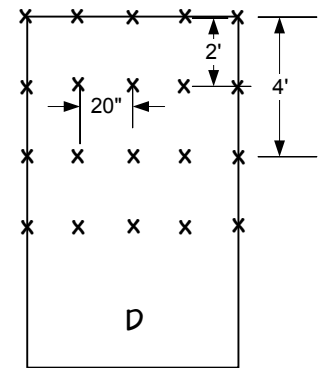

3 1/2 STAPLES PER SQ. YD

FOR OPTIMUM RESULTS, THESE RECOMMENDED STAPLE PATTERN GUIDES MUST BE FOLLOWED. SUGGESTED ANCHORING METHODS VARY ACCORDING TO THE MANUFACTURER. THIS CHART SHOWS HOW TO SLOPE LENGTHS AND HOW GRADIENTS AFFECT SAMPLING PATTERNS.

For environmental review purposes only.



Figure 9
Environmental Protection Plan
Typical Staple Pattern for
Erosion Control Fabric

DATE: 5/25/2001

REVISED: 3/24/2011

SCALE: NTS

DRAWN BY: KMKENDALL

K:\CLIENT PROJECTS\ID-FEEL\2011-019\FIG 9_STAPLE_PATTERN_EROSION_CON TROL_FABRIC.VSD



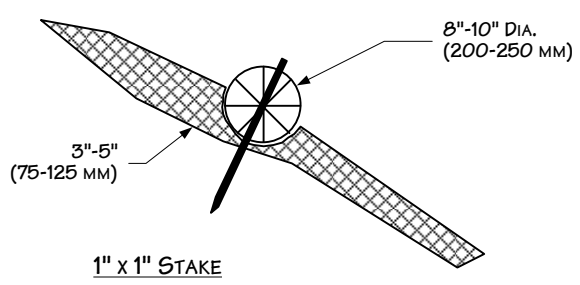
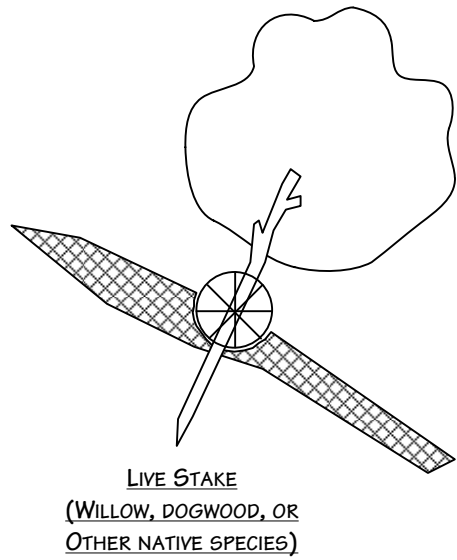
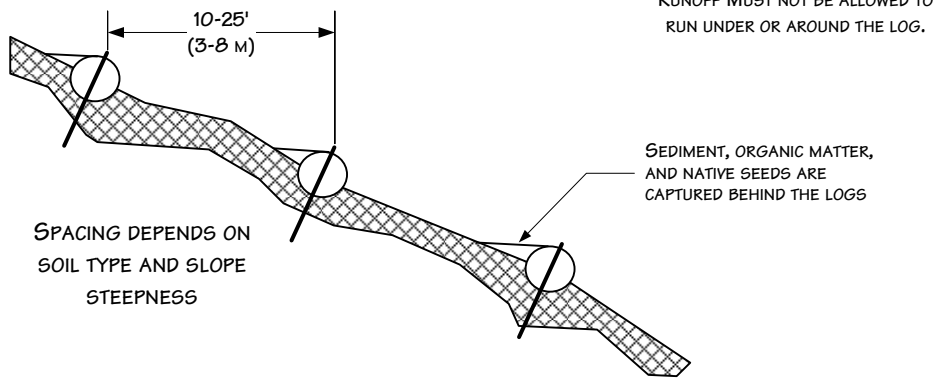
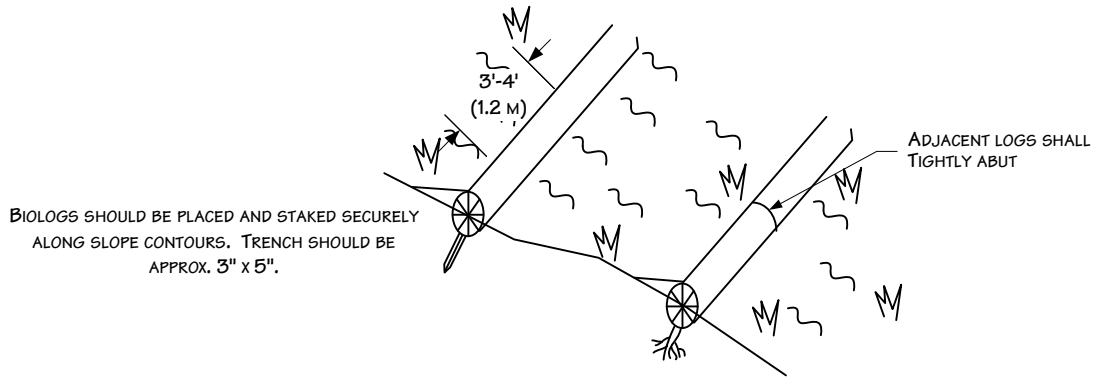

For environmental review purposes only.



Figure 10
Environmental Protection Plan
Typical Biolog Installation

DATE: 5/25/2001	
REVISED: 3/24/2011	
SCALE: NTS	
DRAWN BY: KMKENDALL	
K:\CLIENT PROJECTS\ID-PEEL\2011-019\FIG_10_BIOLOG INSTALL.VSD	

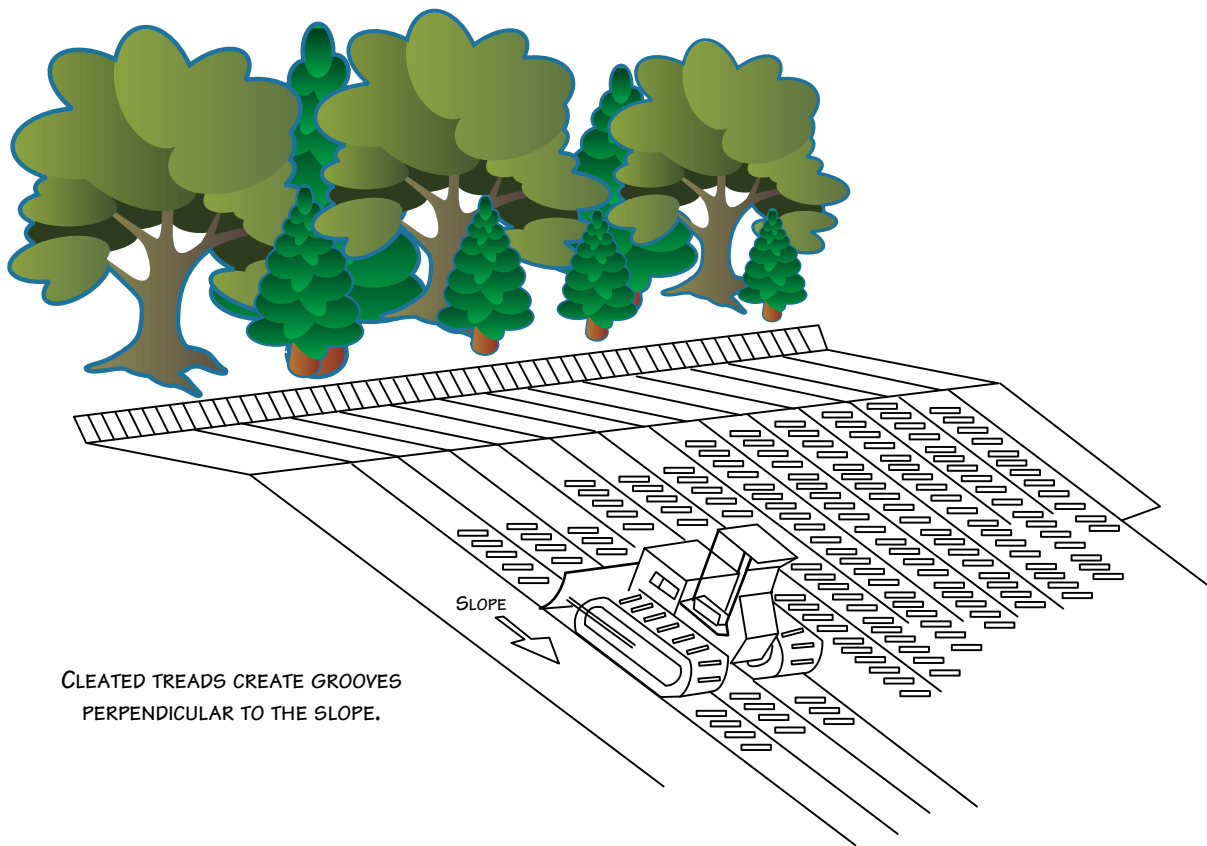

CLEATED TREADS CREATE GROOVES
PERPENDICULAR TO THE SLOPE.

For environmental review purposes only.



Figure 11
Environmental Protection Plan
Typical Cat Tracking

DATE: 5/25/2001

REVISED: 3/24/2011

SCALE: NTS

DRAWN BY: KMKENDALL

K:\CLIENT_PROJECTS\ID-FEEL\2011-019\
FIG_11_CAT_TRACKING.VSD



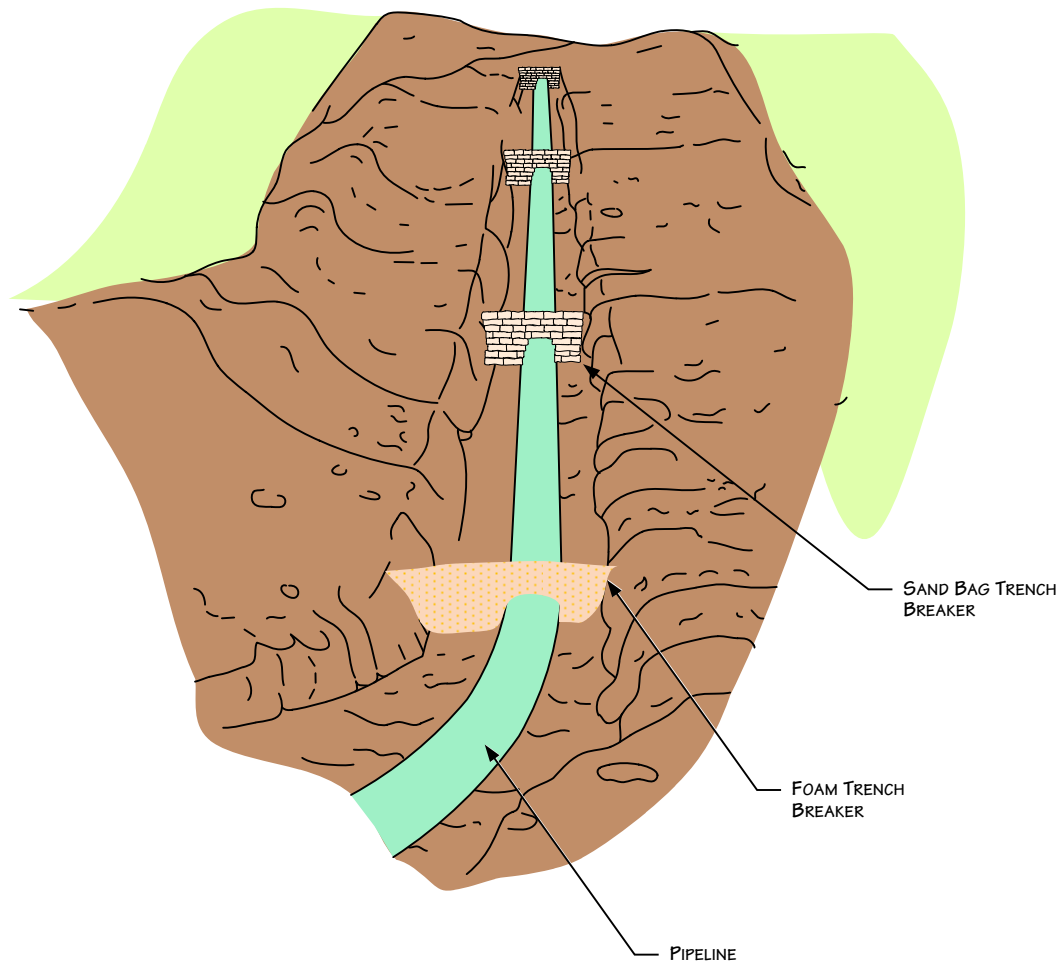

NOTES

1. BAGS WILL NOT BE FILLED WITH TOPSOIL.
2. ADDITIONAL INFORMATION INCLUDED ON OTHER DRAWINGS.

For environmental review purposes only.



Figure 12
Environmental Protection Plan
 Typical Trench Breakers - Perspective View

DATE: 5/25/2001

REVISED: 3/11/11

SCALE: NTS

DRAWN BY: KMKENDALL

K:\CLIENT PROJECTS\ID-FEEL\2011-019\FIG_12_TRENCH_BREAKER_PERSPECTIV E_VIEW.VSD



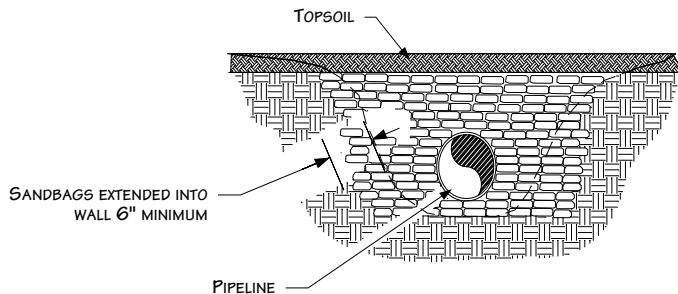
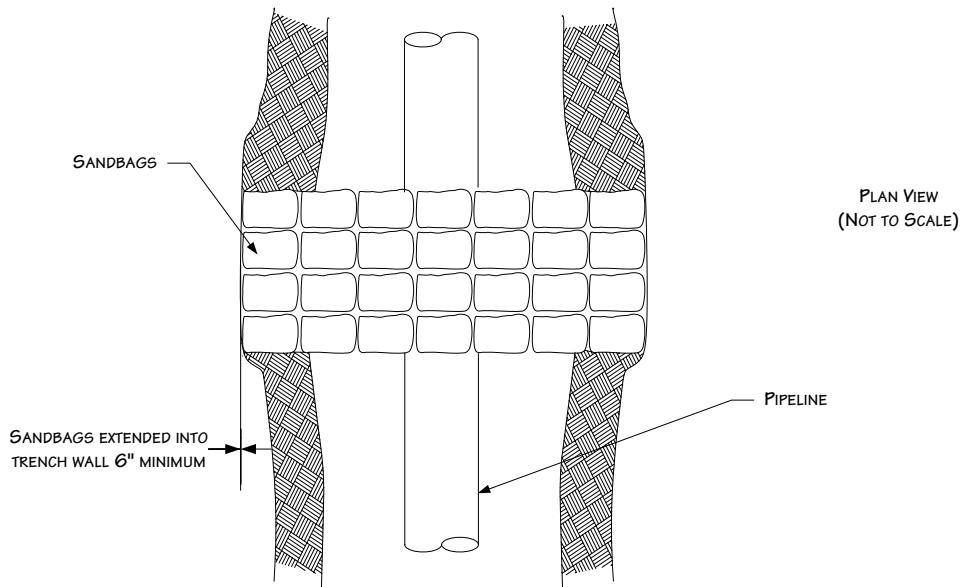
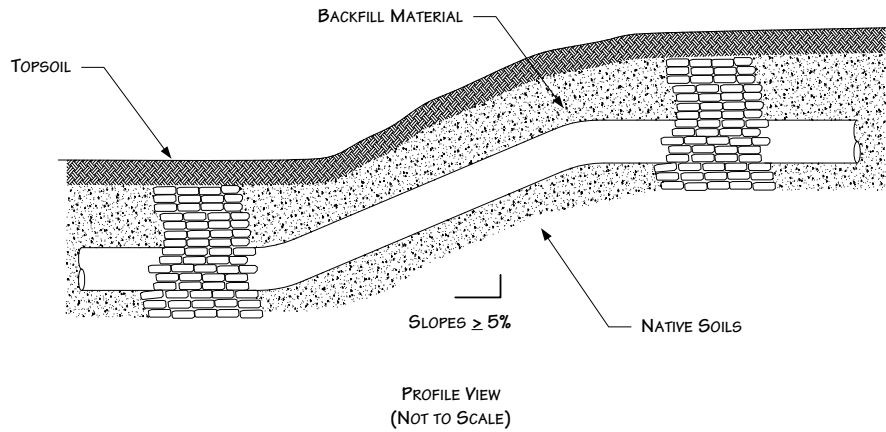

NOTES

1. BAGS WILL NOT BE FILLED WITH TOPSOIL
2. ADDITIONAL INFORMATION INCLUDED ON OTHER DRAWINGS

For environmental review purposes only.



Figure 13
Environmental Protection Plan
 Typical Trench Breakers – Plan & Profile View

DATE: 11/15/2000

REVISED: 3/11/11

SCALE: NTS

DRAWN BY: KMKENDALL

K:\CLIENT PROJECTS\ID-FEEL\2011-019\FIG_13_TRENCH_BREAKER_PLAN_PROFIL_E_VIEW.VSD



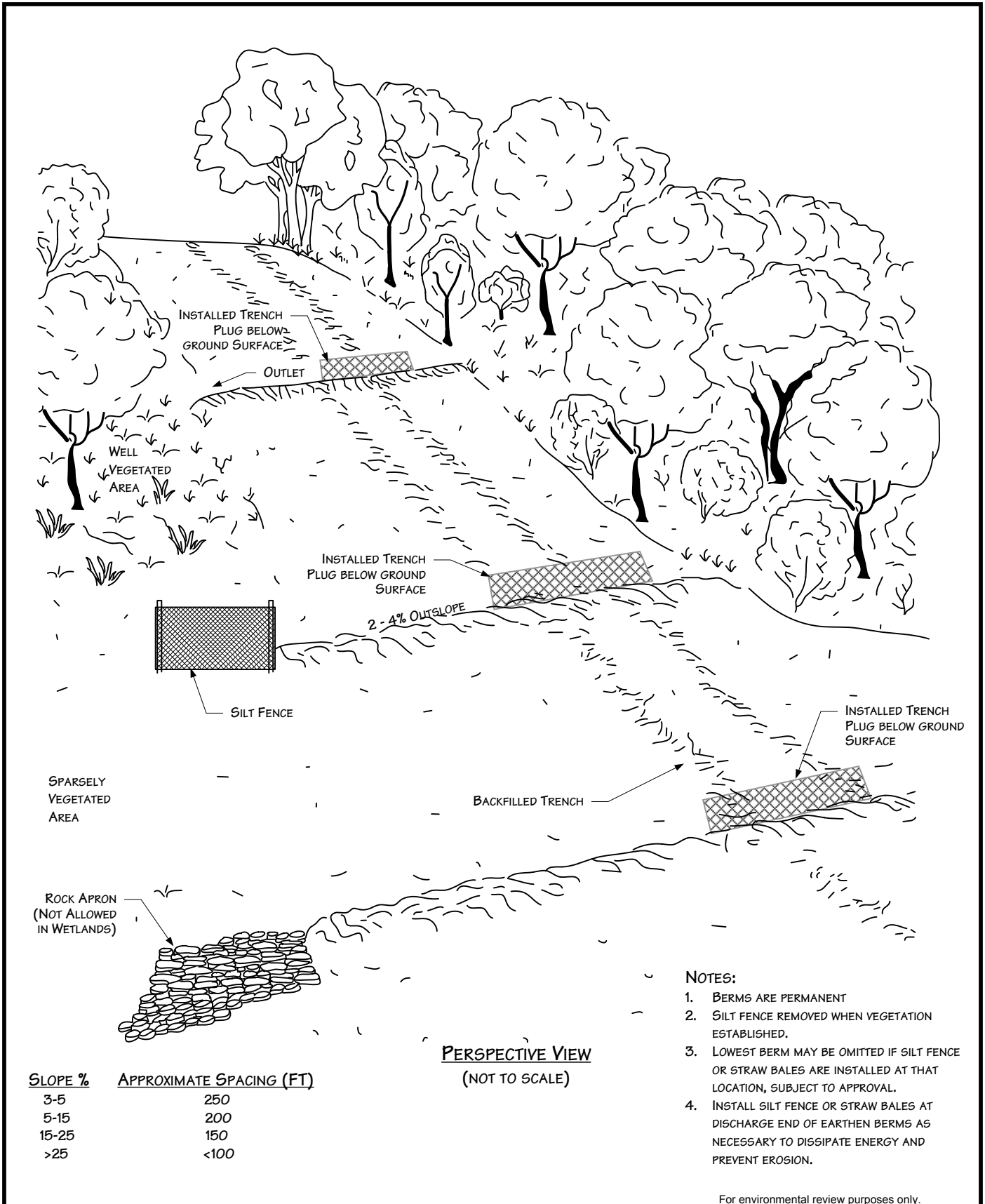

For environmental review purposes only.

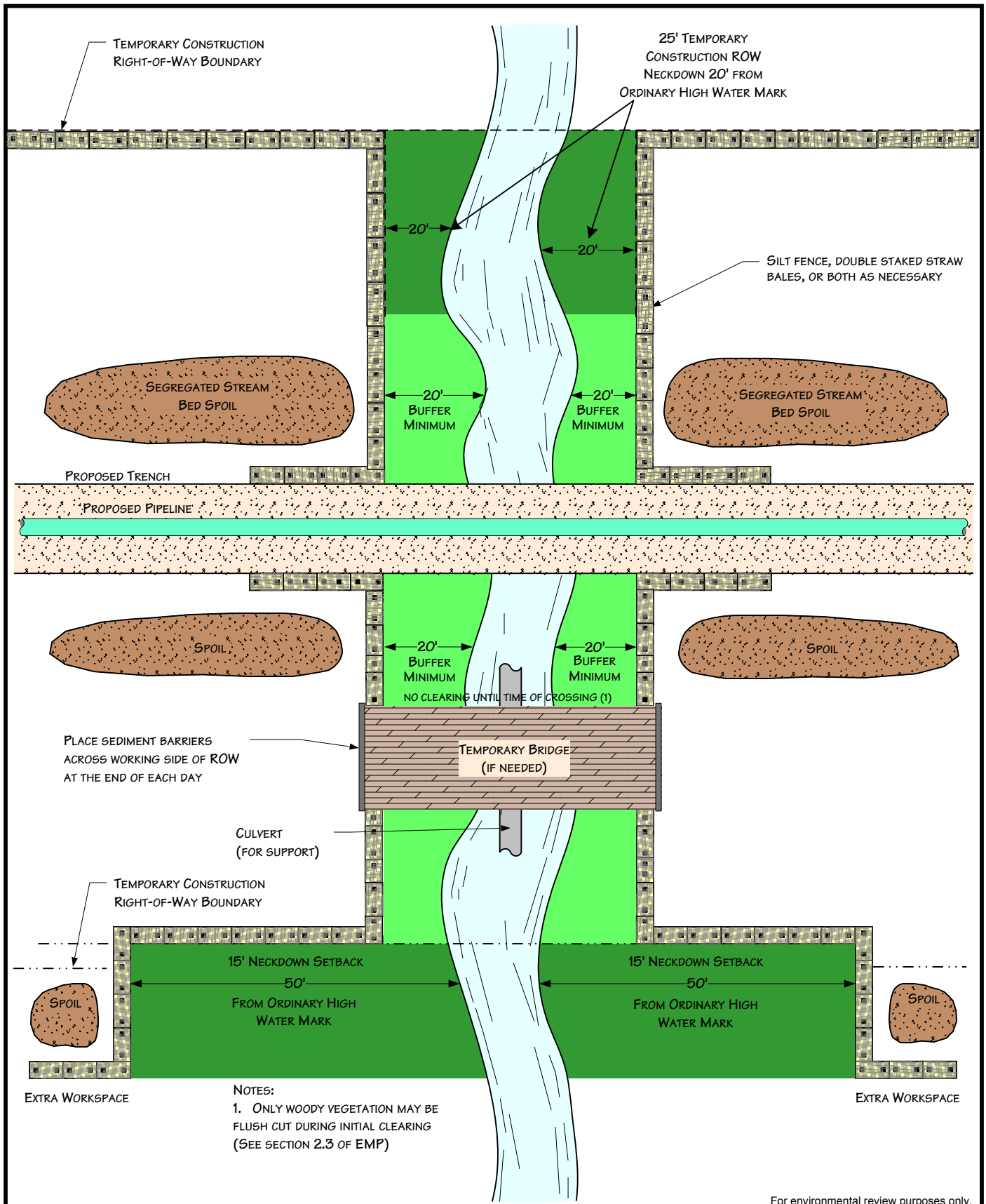

Figure 14
Environmental Mitigation Plan
 Permanent Slope Breakers - Perspective View

DATE: 5/25/2001
 REVISED: 3/11/11
 SCALE: NTS
 DRAWN BY: KMKENDALL

K:\CLIENT PROJECTS\ID-FEEL\2011-019\FIG 14_SLOPE_BREAKERS_PERSPECTIVE_VIEW.VSD





For environmental review purposes only.



Figure 15
Environmental Protection Plan
 Typical Waterbody Crossing
 Open Cut - Wet Trench Method

DATE: 11/29/2005

REVISED: 3/11/11

SCALE: NTS

DRAWN BY: JPB

K:\CLIENT_PROJECTS\0-FIEEL\2011-019\FIG_15_WATERBODY_OPENCUT_WETTRENCH.VSD



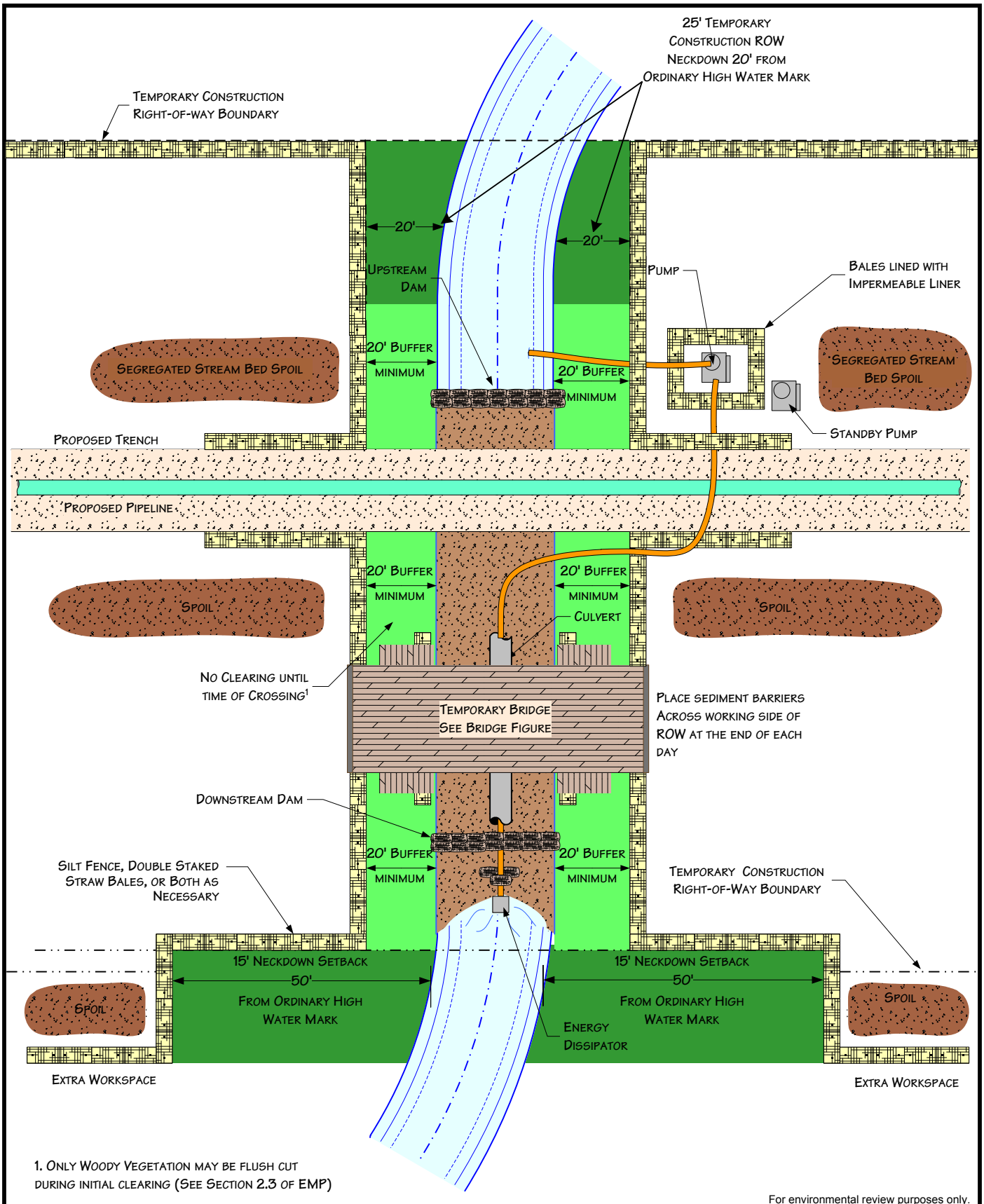
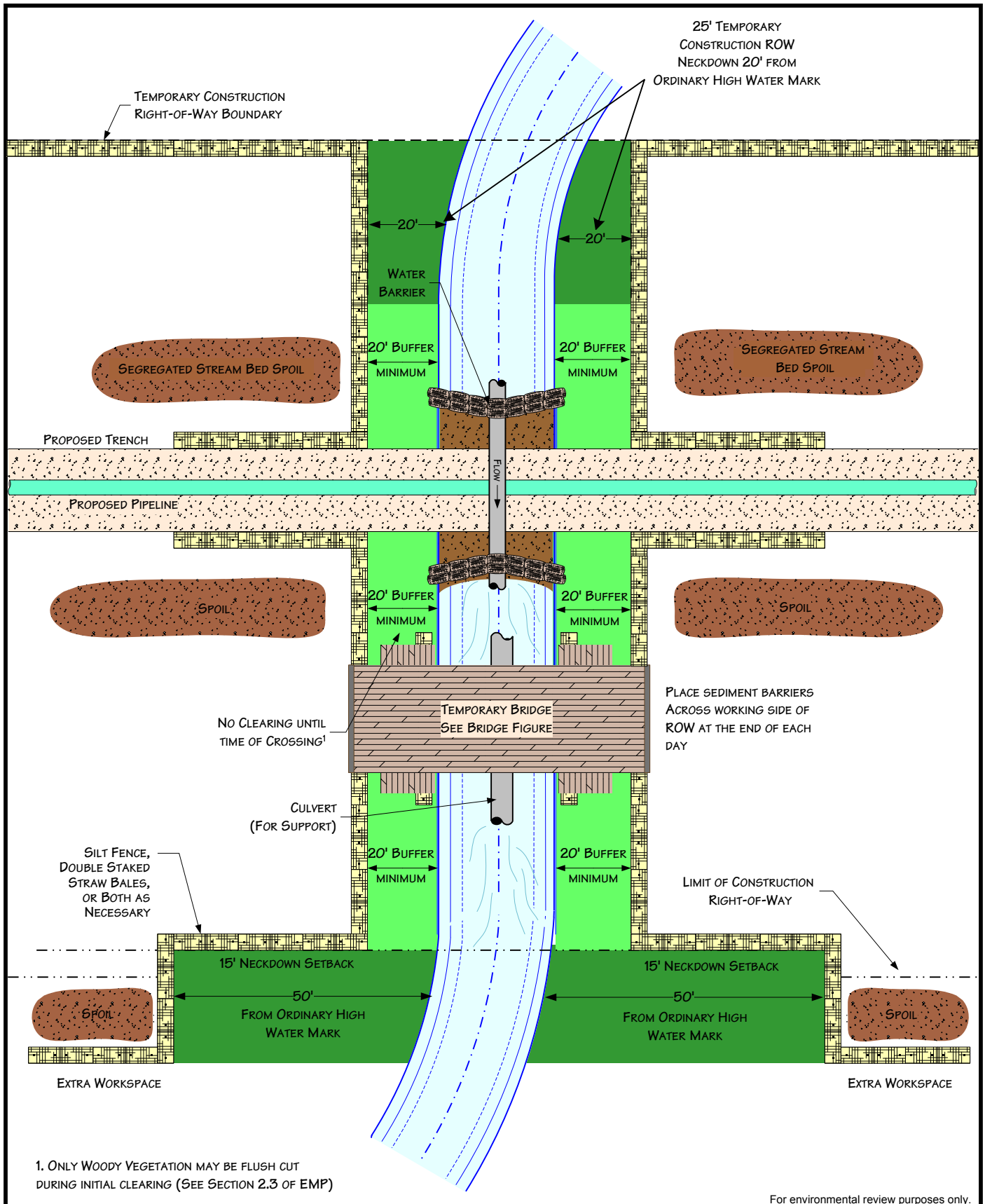

Figure 16
Environmental Protection Plan
 Typical Waterbody Crossing
 Dam and Pump Method

DATE: 11/29/2005	
REVISED: 4/20/09	
SCALE: NTS	
DRAWN BY: JPB	
<small>K:\CLIENT_PROJECTS\ID-PEEL\2011-019\FIG_16_WATERBODY_DAM_AND_PUMP_VSD</small>	



1. ONLY WOODY VEGETATION MAY BE FLUSH CUT DURING INITIAL CLEARING (SEE SECTION 2.3 OF EMP)

For environmental review purposes only.



Figure 17
Environmental Protection Plan
 Typical Waterbody Crossing
 Flume Method

DATE: 11/29/2005

REVISED: 3/11/11

SCALE: NTS

DRAWN BY: JPB

K:\CLIENT_PROJECTS\ID-PEEL\2011-019\FIG_17_WATERBODY_FLUME.VSD



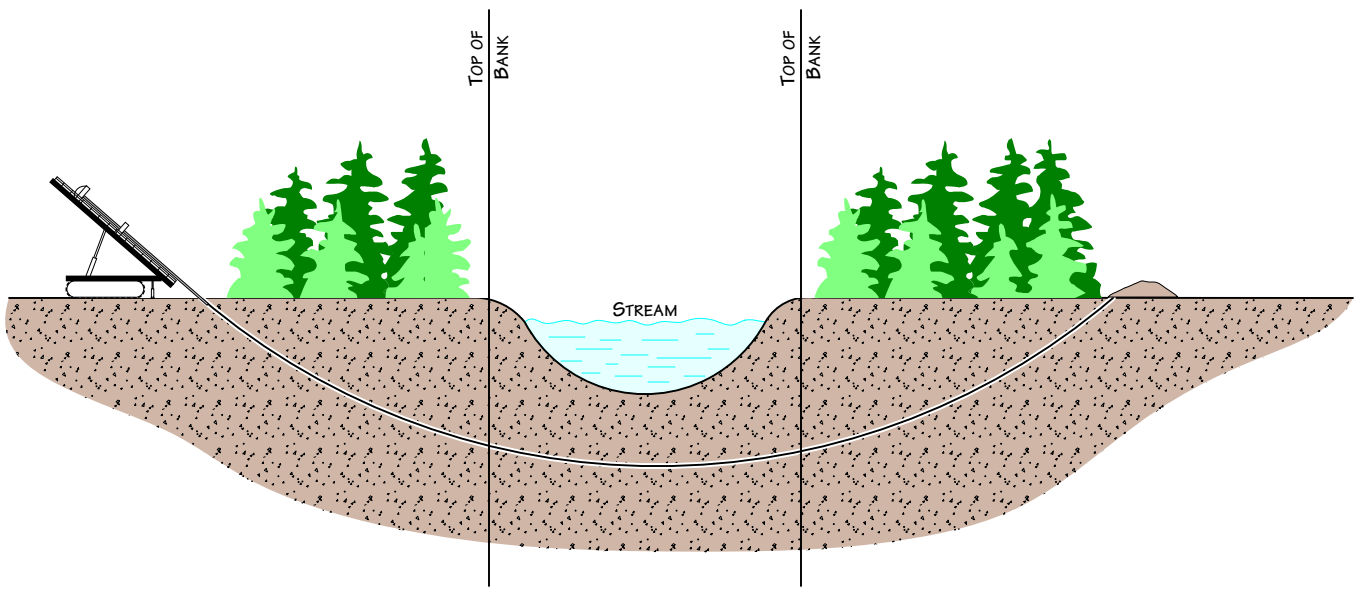

For environmental review purposes only.



Figure 18
Environmental Protection Plan
 Typical Waterbody Crossing
 Directional Drill Method

DATE: 7/14/2000

REVISED: 3/11/11

SCALE: NTS

DRAWN BY: KMKENDALL

K:\CLIENT PROJECTS\ID-FEEL\2011-019\FIG_18_WATERBODY_DIRECTIONAL_DRILL.VSD



Plan View

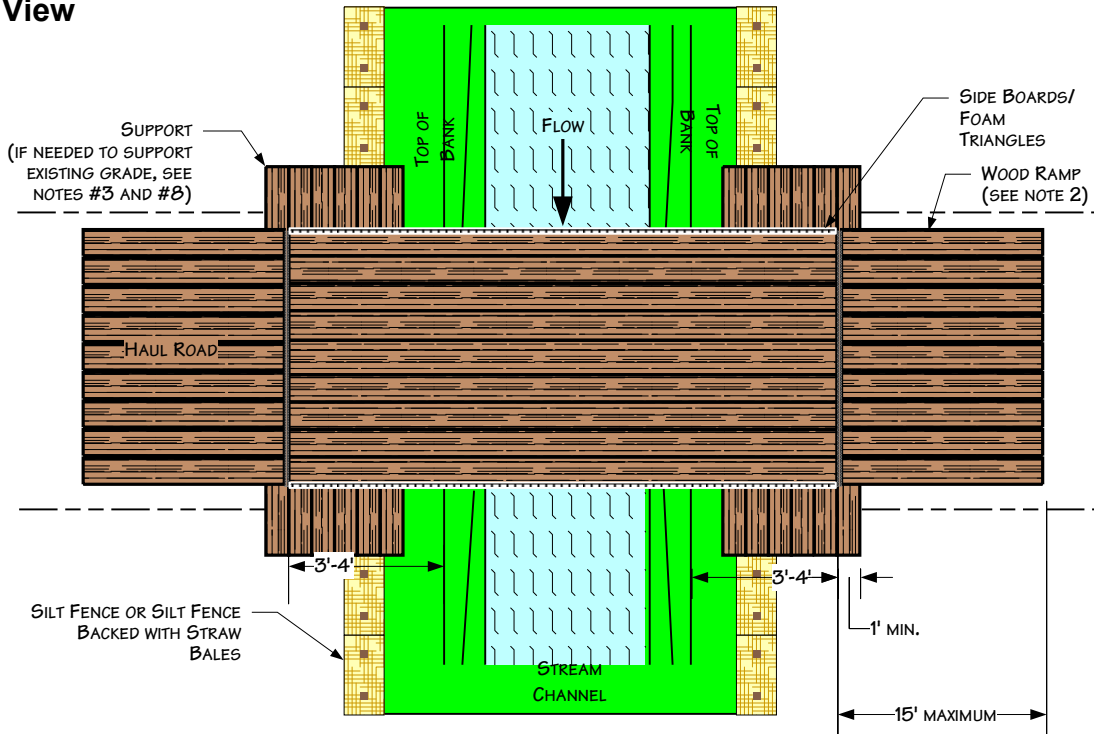

Profile View

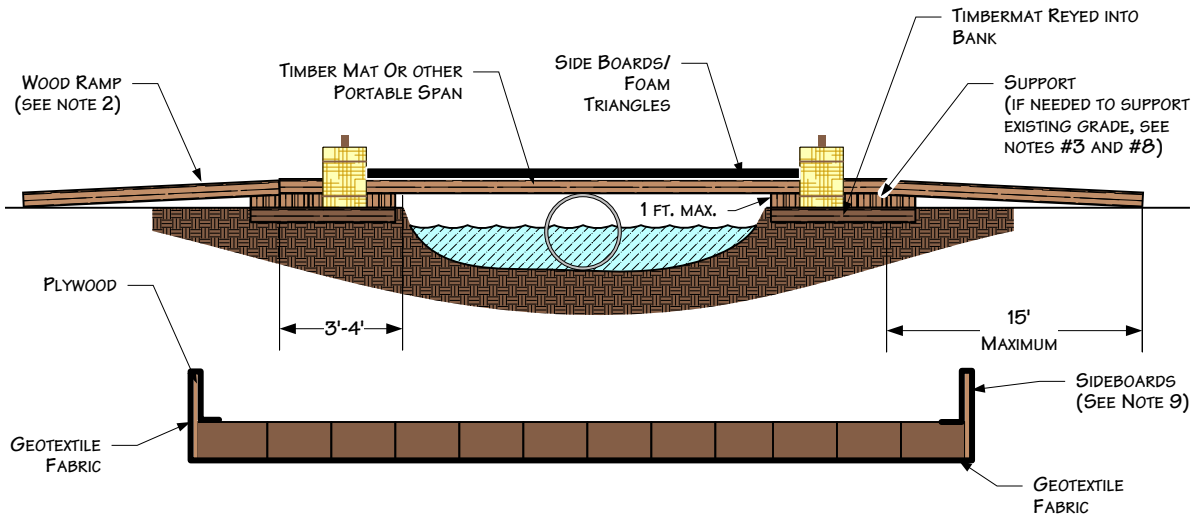

NOTES:

1. INSPECT BRIDGE OPENING PERIODICALLY AND FOLLOWING RAINFALLS OF OVER 1/2". REMOVE ANY DEBRIS RESTRICTING FLOW AND DEPOSIT IT AT AN UPLAND SITE OUTSIDE OF FLOODPLAIN.
2. IF PHYSICAL CIRCUMSTANCES PROHIBIT WOOD OR METAL RAMPS, EARTHEN RAMPS MAY BE USED AS APPROVED.
3. INSPECT BRIDGE ELEVATION SO BRIDGE REMAINS SUPPORTED ABOVE HIGH BANK AND DOES NOT SINK INTO BANK.
4. THE CULVERT SUPPORT MUST BE ANCHORED TO THE STREAM BOTTOM AND MAY NOT BE SUPPORTED WITH FILL.
5. EARTHEN RAMP CANNOT BE TALLER THAN 1' AND CANNOT EXTEND FOR MORE THAN 15' ON EITHER SIDE OF THE CROSSING.
6. THE BRIDGE MUST SPAN FROM TOP OF BANK TO TOP OF BANK.
7. ADDITIONAL SUPPORT MUST BE ADDED ON TOP OF BANK AND UNDER SPAN IF INITIAL SUPPORT STARTS TO SETTLE.
8. EROSION AND SEDIMENTATION CONTROL MEASURES SHALL BE INSPECTED AND MAINTAINED IN ACCORDANCE WITH THE COMPANY'S ENVIRONMENTAL MITIGATION PLAN
9. SIDEBARDS WILL BE INSTALLED ON TEMPORARY BRIDGES TO MINIMIZE THE POTENTIAL FOR SEDIMENT TRANSPORT. SIDEBARDS MAY BE CONSTRUCTED OUT OF PLYWOOD, OR EQUIVALENT, AND AFFIXED TO THE OUTER SIDES OF THE BRIDGE. GEO-TEXTILE FABRIC, OR EQUIVALENT, MUST ALSO BE ADEQUATELY SECURED TO THE UNDERSIDE OF THE BRIDGE TO PREVENT MATERIAL FROM FALLING THROUGH THE BRIDGE DECK. THE GEO-TEXTILE FABRIC OR AN EQUIVALENT SHOULD BE SECURED TO THE BOTTOM OF THE BRIDGE AND WRAPPED AROUND THE SIDEBARDS IN A CONTINUOUS FASHION.

For environmental review purposes only.



Figure 19
Environmental Protection Plan
 Typical Span Type Bridge
 With or Without Instream Support

DATE: 3/11/2003	
REVISED: 3/25/2011	
SCALE: NTS	
DRAWN BY: KMK6792	
K:\ CLIENT PROJECTS\ID-FEEL\2011-019\ FIG_19_BRIDGE_SPAN.VSD	

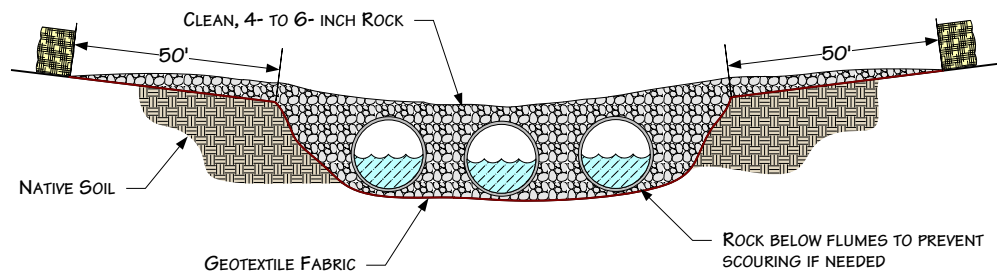
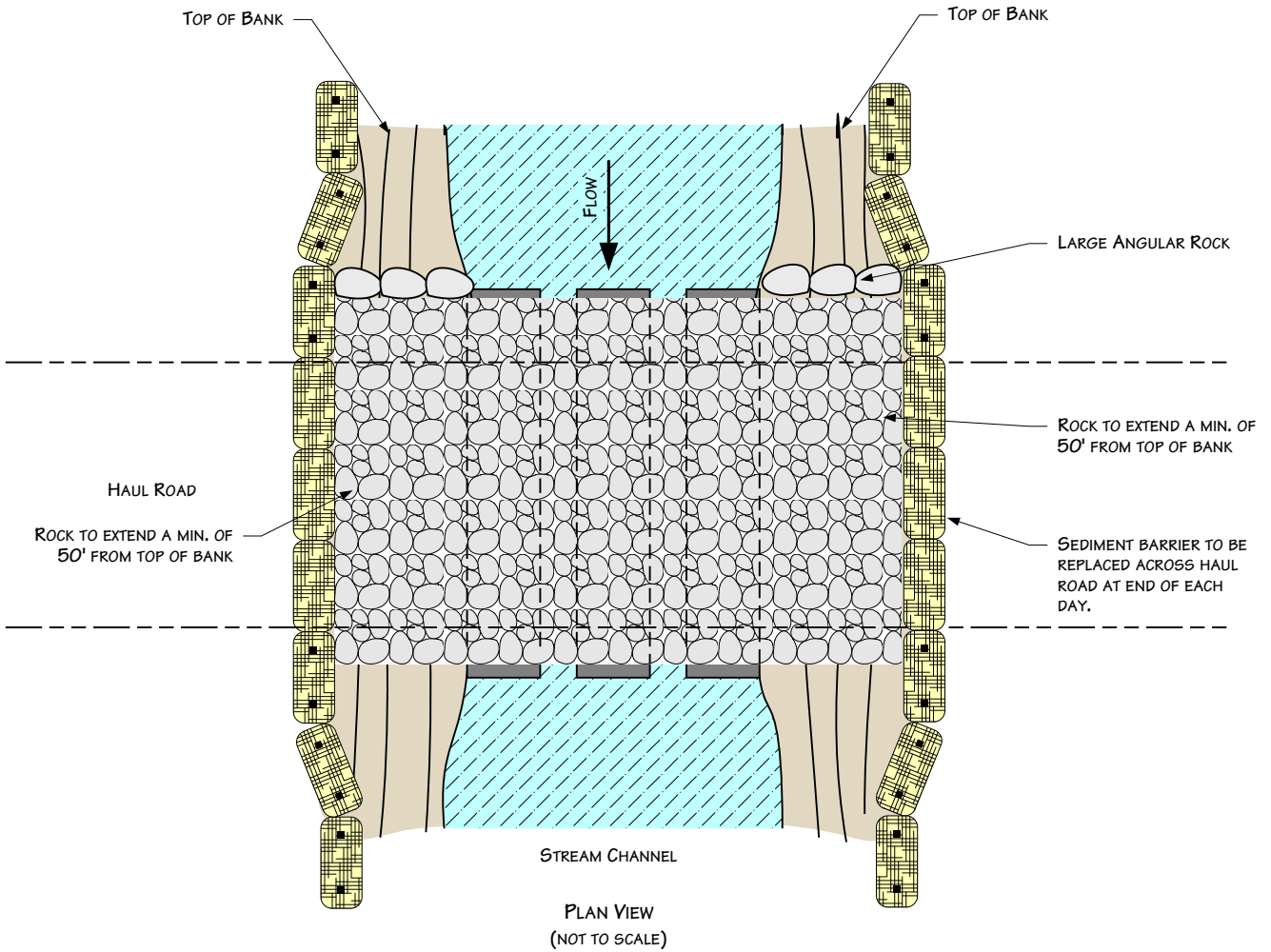

NOTES:

1. STEEL FLUME PIPE(S) SIZED TO ALLOW FOR STREAM FLOW AND EQUIPMENT LOAD.
2. STRAW BALES SHALL BE PLACED ACROSS BRIDGE ENTRANCE EVERY NIGHT.
3. ADDITIONAL INFORMATION INCLUDED ON OTHER DRAWINGS.

For environmental review purposes only.



Figure 20
Environmental Protection Plan
Typical Rock Flume Bridge

DATE: 5/25/2001

REVISED: 3/15/11

SCALE: NTS

DRAWN BY: KMKENDALL

K:\CLIENT PROJECTS\ID-PEEL\2011-019\FIG_20_ROCK_FLUME_BRIDGE.VSD



DEWATERING DISCHARGE IN WELL VEGETATED UPLANDS

NOTES:

1. PUMP INTAKE HOSE MUST BE SECURED AT LEAST ONE FOOT ABOVE THE TRENCH BOTTOM.
2. DEWATER INTO GEOTEXTILE FILTER BAG OR STRAW BALE DEWATERING STRUCTURE.

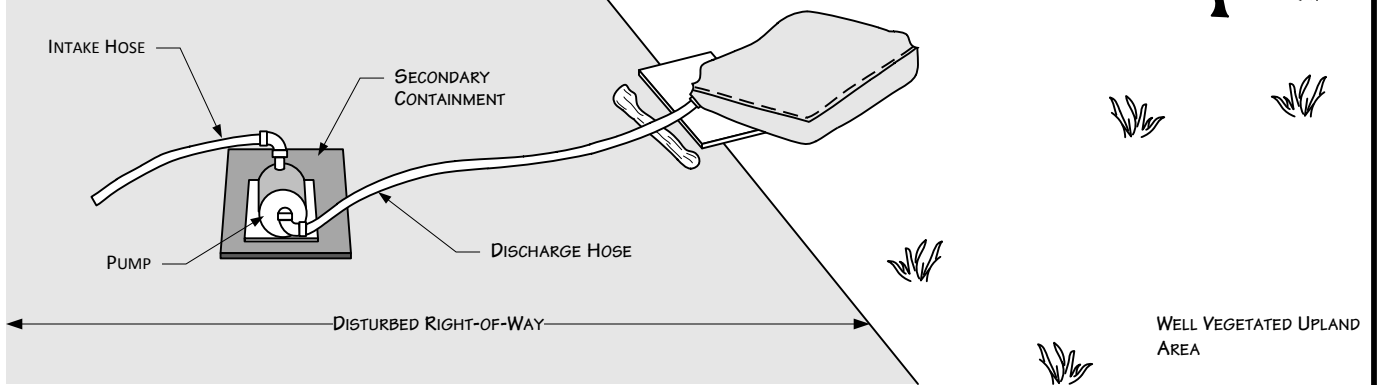

GEOTEXTILE FILTER BAG

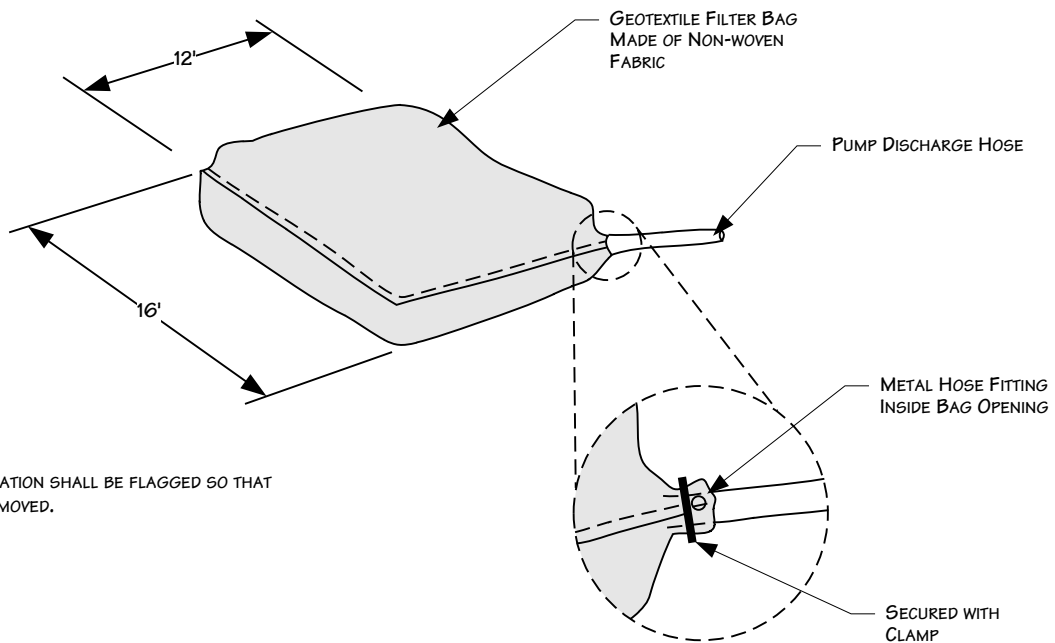

NOTE:

1. FILTER BAG LOCATION SHALL BE FLAGGED SO THAT BAG CAN BE REMOVED.

For environmental review purposes only.



Figure 21
Environmental Protection Plan
Typical Dewatering Measures

DATE: 5/25/2001

REVISED: 3/15/11

SCALE: NTS

DRAWN BY: KMKENDALL

K:\CLIENT_PROJECTS\SD-FEEL\2011-019\FIG_21_DEWATERING_MEASURES.VSD



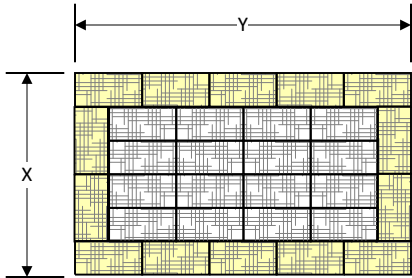

NOTES

1. ARRANGE THE STRAW BALES TO THE X AND Y DIMENSIONS AS SPECIFIED BELOW.
2. IF BOTTOM OF STRUCTURE IS NOT LINED WITH STRAW BALES (OPTION 1), LINE ENTIRE STRUCTURE WITH GEOTEXTILE FILTER FABRIC.

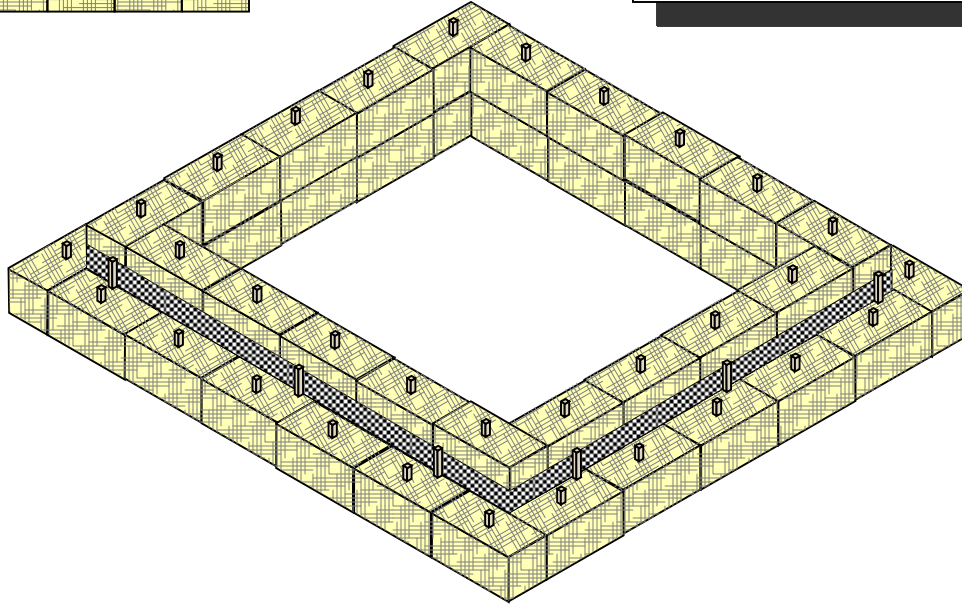

PERSPECTIVE VIEW

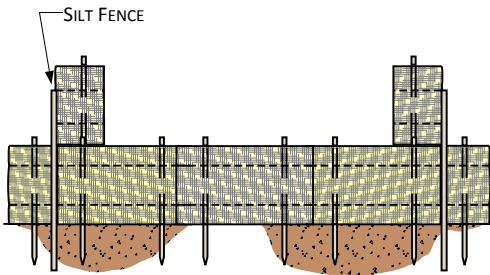

OPTION 1

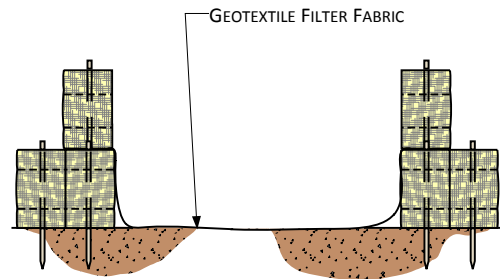

OPTION 2

TYPICAL MINIMUM SUMP DIMENSIONS (FEET)		MAXIMUM PUMPING RATE GALLONS PER MINUTE
X	Y	
10	20	300
15	20	350
20	20	400
20	25	450
25	25	500
25	30	550
30	30	660

For environmental review purposes only.

Figure 22A
Environmental Protection Plan
Straw Bale Dewatering Structure



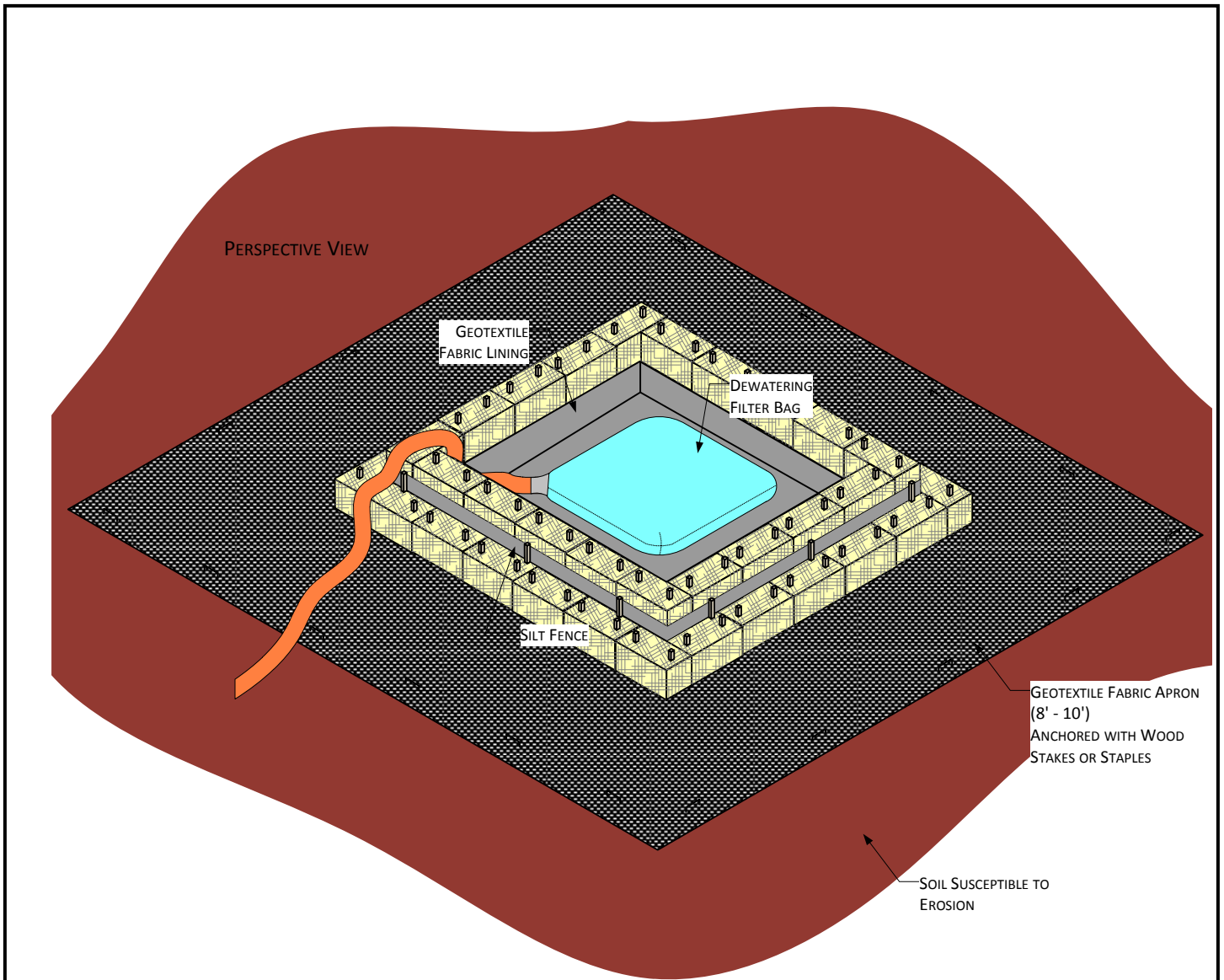

CONSTRUCT DEWATERING STRUCTURE TO ACCOMMODATE ANTICIPATED PUMPING RATES. SEE EXAMPLE BELOW.

EXAMPLE PUMPING RATE = 200 G.P.M.

STORAGE VOLUME (C.F.) = 16 x 200 G.P.M. = 3200 C.F.

HEIGHT OF STRAW BALE STRUCTURE = 3 FEET (2 BALES STACKED) (BASED ON HEIGHT OF BALES, NOT SILT FENCE)

INSIDE DIMENSIONS OF STRUCTURE = 33 X 33 FEET SQUARE

NOTES:

1. SILT FENCE ENDS MUST BE WRAPPED TO JOIN TWO SECTIONS.
2. INSTALL SILT FENCE 2 INCHES ABOVE TOP OF STRAW BALES, AND ANCHOR A MINIMUM OF 8 INCHES STRAIGHT DOWN.
3. SILT FENCE POST STAKING MUST BE 4 FEET OR LESS.
4. DEWATERING INTAKE HOSE SUPPORTED AT LEAST 1 FOOT FROM BOTTOM OF TRENCH BEING DEWATERED.
5. EROSION AND SEDIMENTATION CONTROL MEASURES SHALL BE INSPECTED AND MAINTAINED IN ACCORDANCE WITH THE COMPANY'S UPLAND EROSION CONTROL, REVEGETATION, AND MAINTENANCE PLAN.

For environmental review purposes only.

Figure 22B
Environmental Protection Plan
Straw Bale Dewatering Structure



PERSPECTIVE VIEW

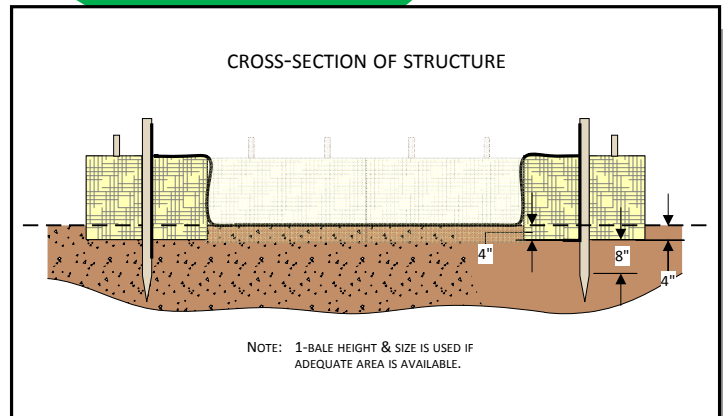
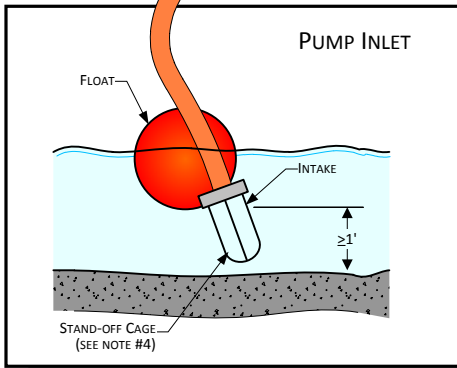
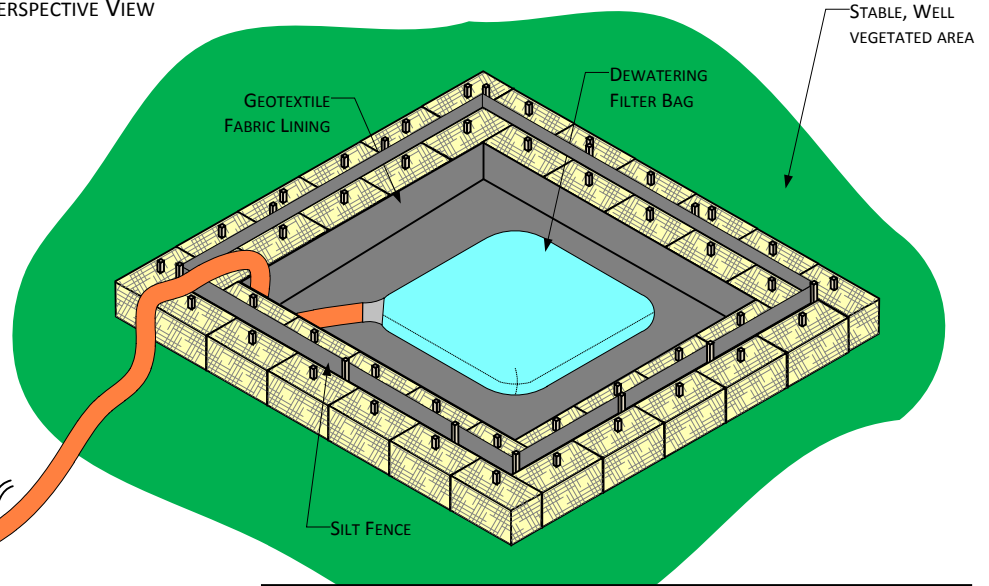

CONSTRUCT DEWATERING STRUCTURE TO ACCOMMODATE ANTICIPATED PUMPING RATES. SEE EXAMPLE BELOW.

EXAMPLE PUMPING RATE = 200 G.P.M.
 STORAGE VOLUME (C.F.) = 16 x 200 G.P.M. = 3200 C.F.
 HEIGHT OF STRAW BALE STRUCTURE = 1.5 FEET (1 BALE) (BASED ON HEIGHT OF BALES, NOT SILT FENCE)
 INSIDE DIMENSIONS OF STRUCTURE = 46 x 46 FEET SQUARE

NOTES:

1. SILT FENCE ENDS MUST BE WRAPPED TO JOIN TWO SECTIONS.
2. INSTALL SILT FENCE 2 INCHES ABOVE TOP OF STRAW BALE, AND ANCHOR A MINIMUM OF 8 INCHES STRAIGHT DOWN.
3. SILT FENCE POST STAKING MUST BE 4 FEET OR LESS.
4. DEWATERING INTAKE HOSE SUPPORTED AT LEAST 1 FOOT FROM BOTTOM OF TRENCH BEING DEWATERED.
5. USE A FILTER BAG AT THE DISCHARGE HOSE END.
6. EROSION AND SEDIMENTATION CONTROL MEASURES SHALL BE INSPECTED AND MAINTAINED IN ACCORDANCE WITH THE COMPANY'S UPLAND EROSION CONTROL, REVEGETATION, AND MAINTENANCE PLAN.

For environmental review purposes only.

Figure 22C
Environmental Protection Plan
Straw Bale Dewatering Structure



NOTE: PLACE JUTE BLANKET A MINIMUM OF ONE (1) FOOT UNDER RIP RAP. EXTEND JUTE BLANKET FROM MEAN HIGH WATER LEVEL TO SEVERAL FEET BEHIND HIGH BANK.

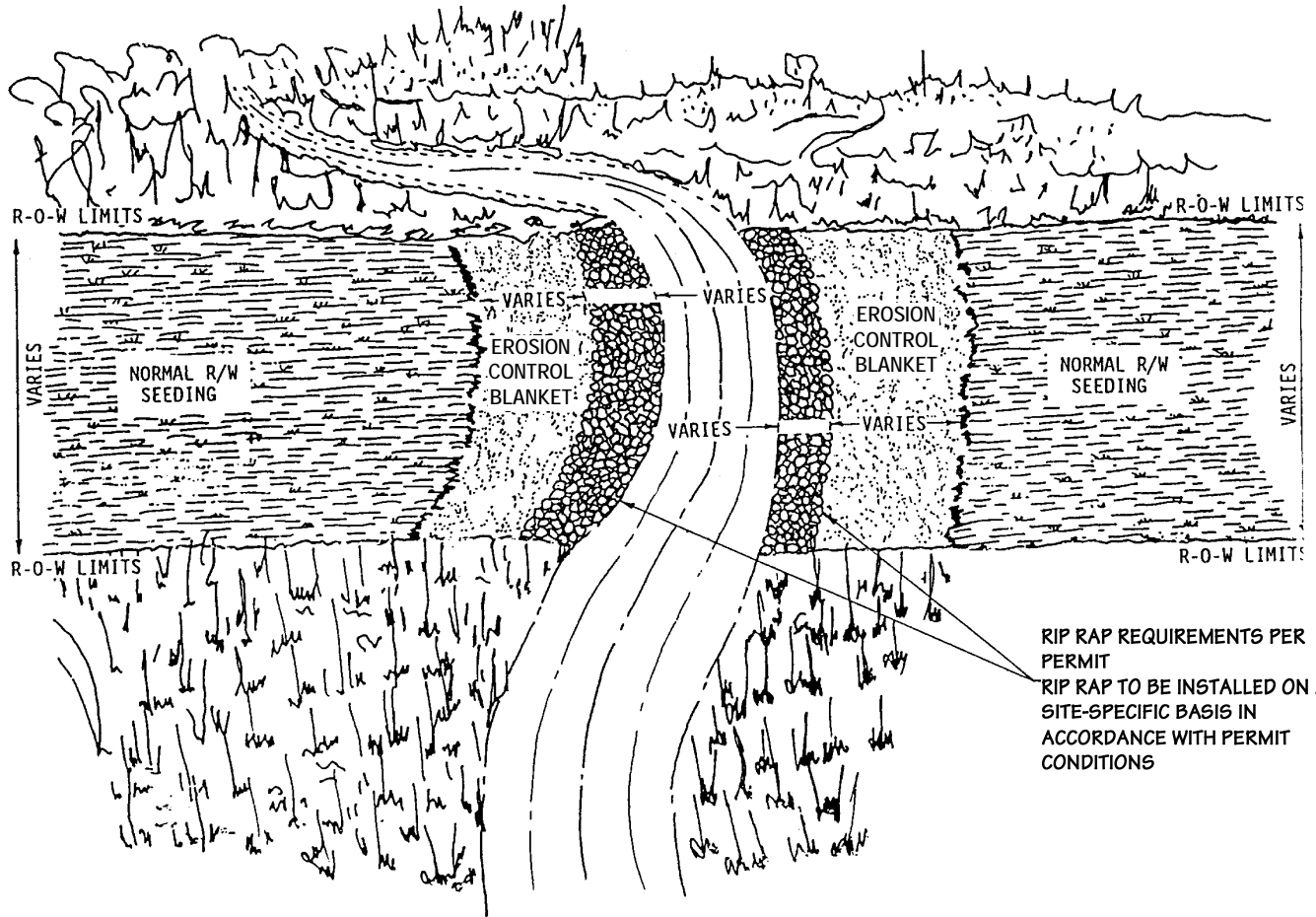

RIP RAP REQUIREMENTS PER PERMIT
RIP RAP TO BE INSTALLED ON A SITE-SPECIFIC BASIS IN ACCORDANCE WITH PERMIT CONDITIONS

For environmental review purposes only.

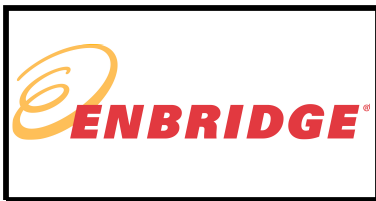

Figure 23
Environmental Protection Plan
Typical Final Stream Bank Stabilization
Rip Rap & Erosion Control

DATE: 7/19/2000
REVISED: 3/14/11
SCALE: NTS
DRAWN BY: KMKENDALL
K:\CLIENT PROJECTS\SD-FEEL\2011-019\FIG_23_STREAM_BANK_STABILIZATION.VSD



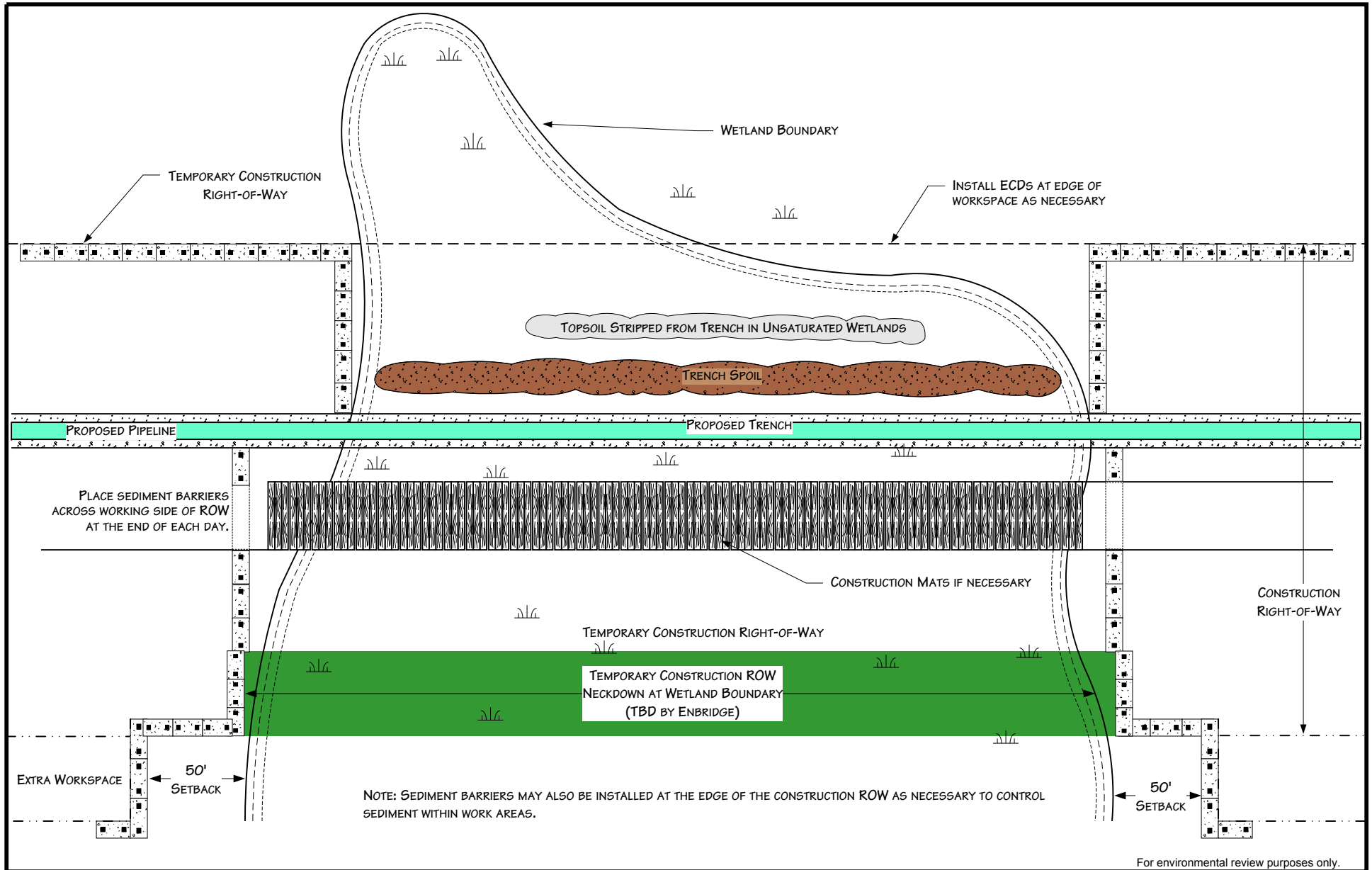

Figure 24
Environmental Protection Plan
 Typical Wetland Crossing Method

DATE: 5/25/2001

REVISED: 3/14/11

SCALE: NTS

DRAWN BY: KMKENDALL

K:\CLIENT PROJECTS\ID-FEEL\2011-019\FIG_24_WETLAND_CROSSING_METHOD.VSD



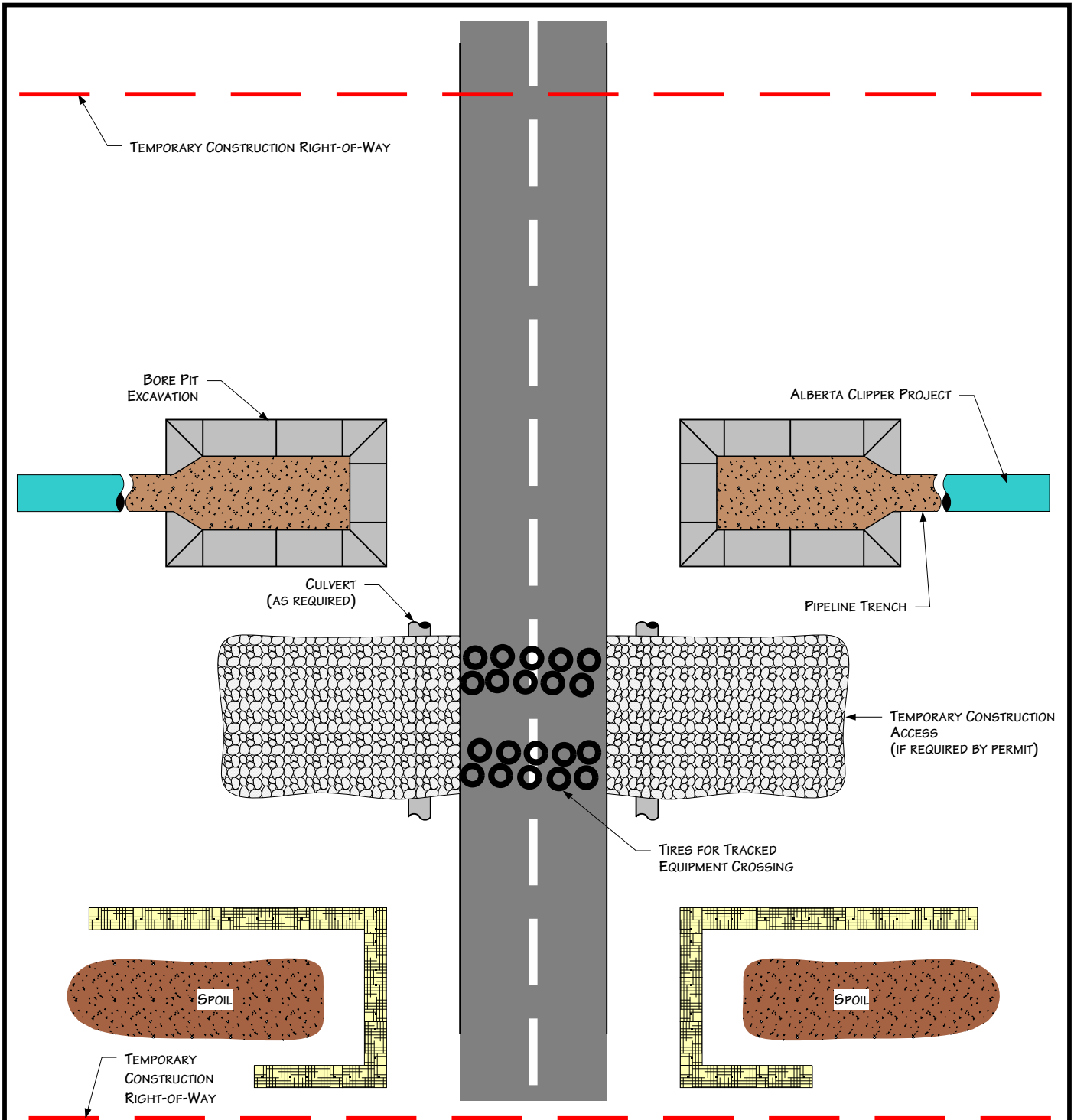

PLAN VIEW

NOTES

1. PROCEDURES SHOWN IN THIS DRAWING APPLY TO IMPROVED ROADS.
2. ROADS MUST BE CLEANED AFTER EQUIPMENT CROSSES AND DIRT PLACED IN SPOIL CONTAINMENT AREAS.
3. TEMPORARY ACCESS MATERIALS MUST BE REMOVED UPON PROJECT COMPLETION.
4. ADDITIONAL INFORMATION INCLUDED ON OTHER DRAWINGS OR PERMITS.
5. CONSTRUCTION AREAS LOCATED OUTSIDE ROAD ROW.

For environmental review purposes only.



Figure 25
Environmental Protection Plan
 Typical Improved Road Crossing
 Directional Bore Method

DATE: 7/13/1999	
REVISED: 3/14/11	
SCALE: NTS	
DRAWN BY: KMKENDALL	
<small>K:\CLIENT_PROJECTS\0-PIEEL\2011-019\FIG_25_IMPROVED_ROAD_BORE_CROSSING.VSD</small>	

TYPICAL CROSS SECTION – BIOLOG

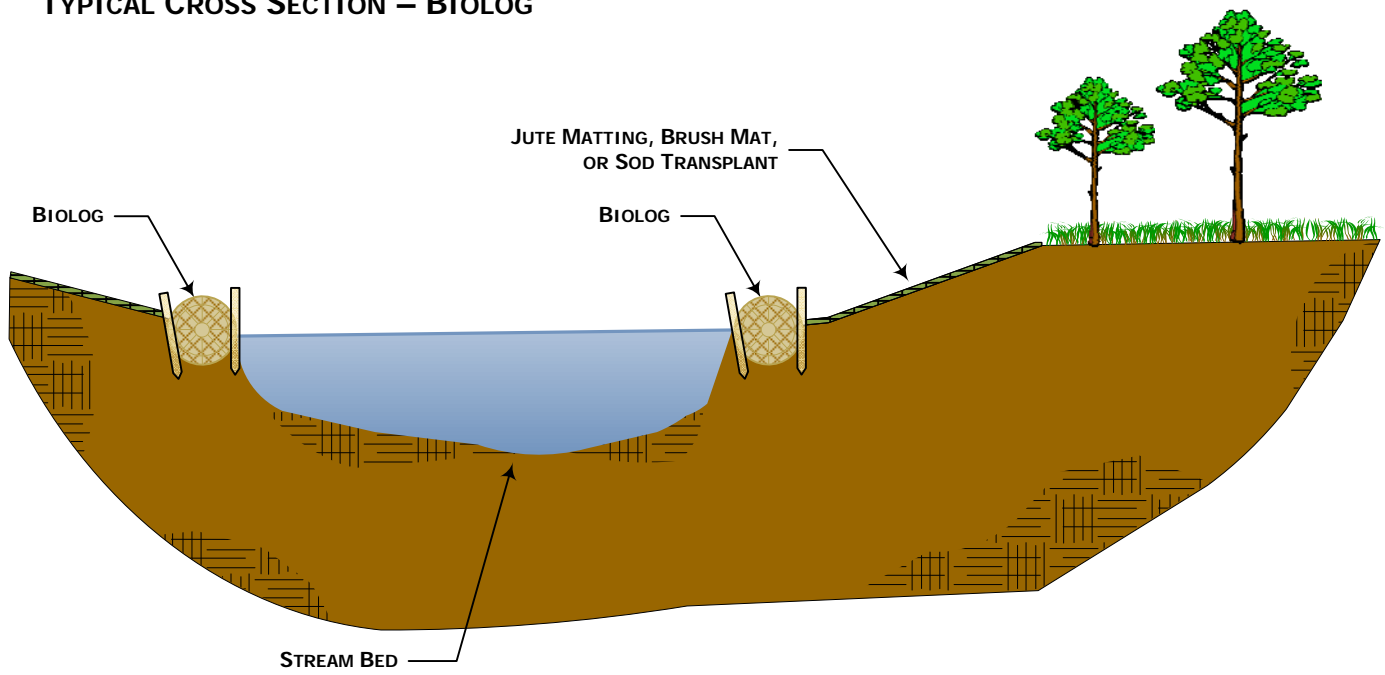

TYPICAL PLAN VIEW – BIOLOG

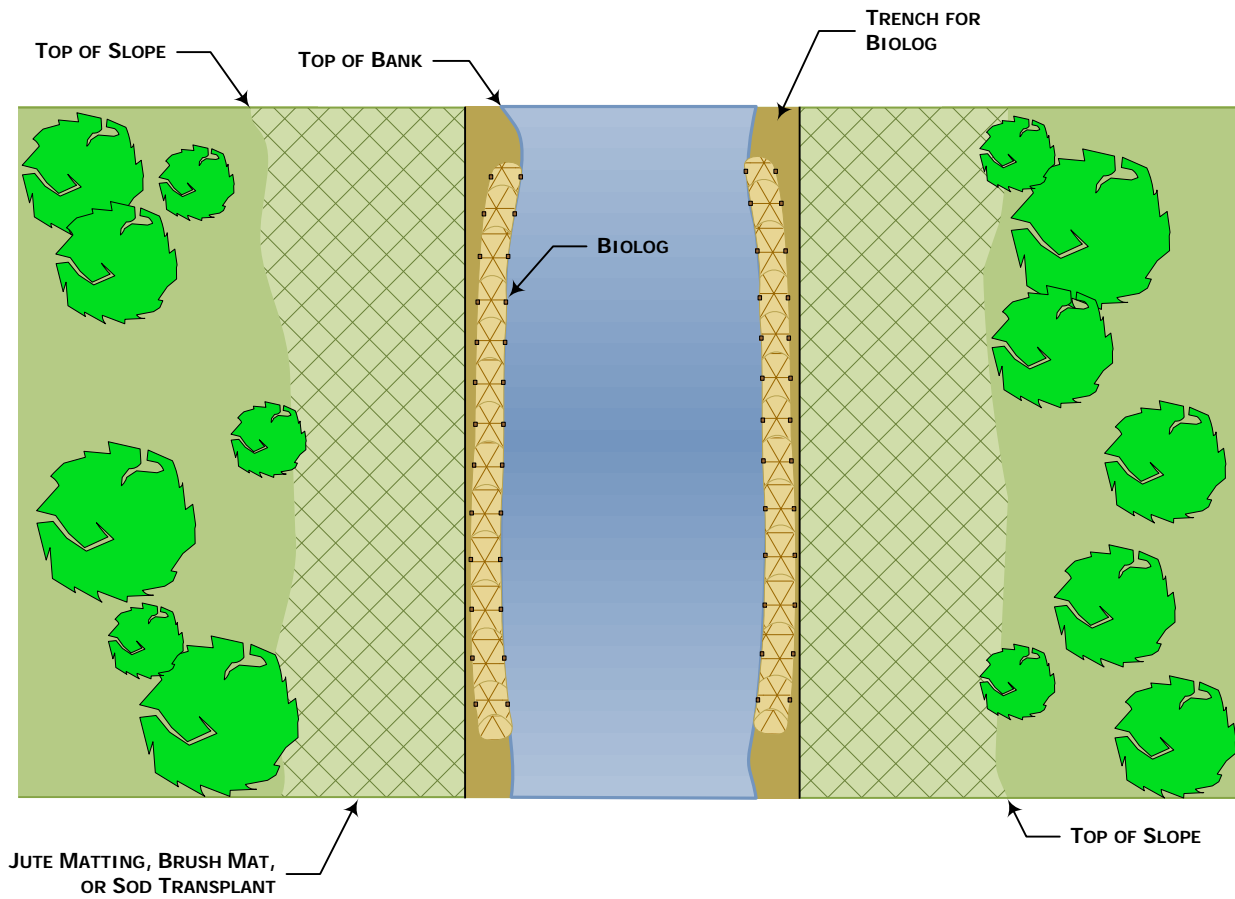

TYPICAL CROSS SECTION – SOD TRANSPLANT

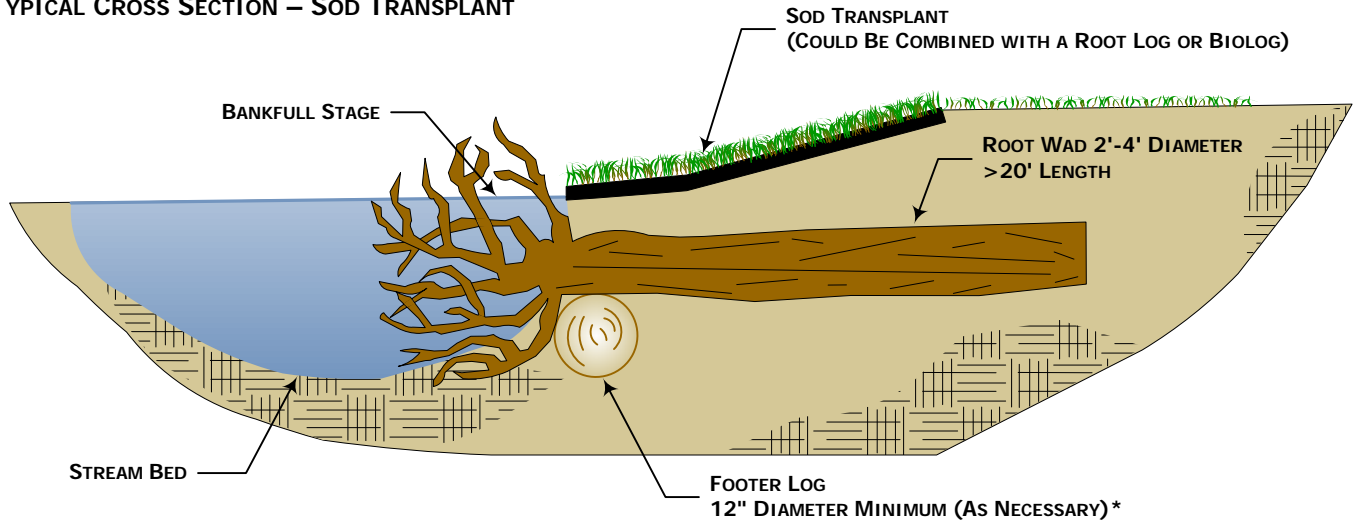

TYPICAL CROSS SECTION – JUTE MAT

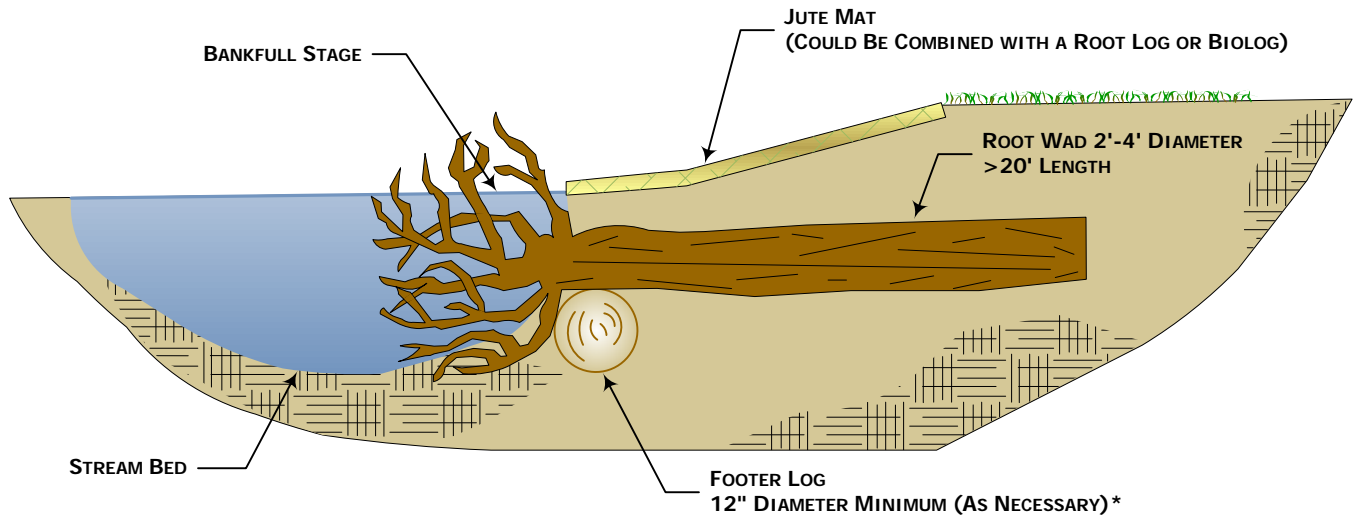

TYPICAL CROSS SECTION – BRUSH MAT

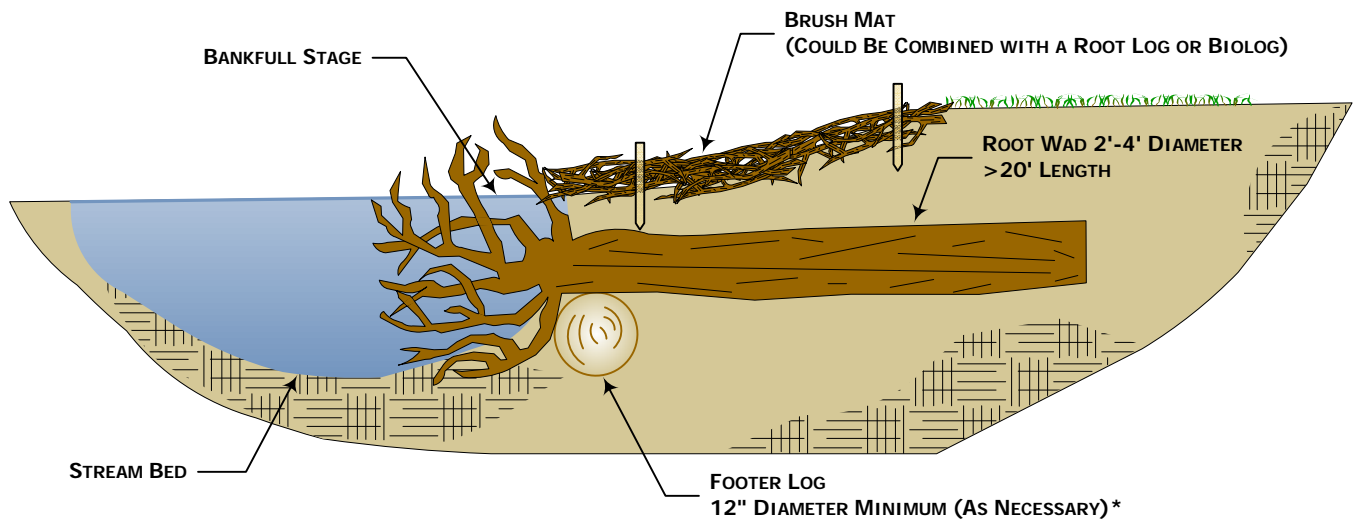

TYPICAL PLAN VIEW – NATURAL MATERIAL REVETMENT

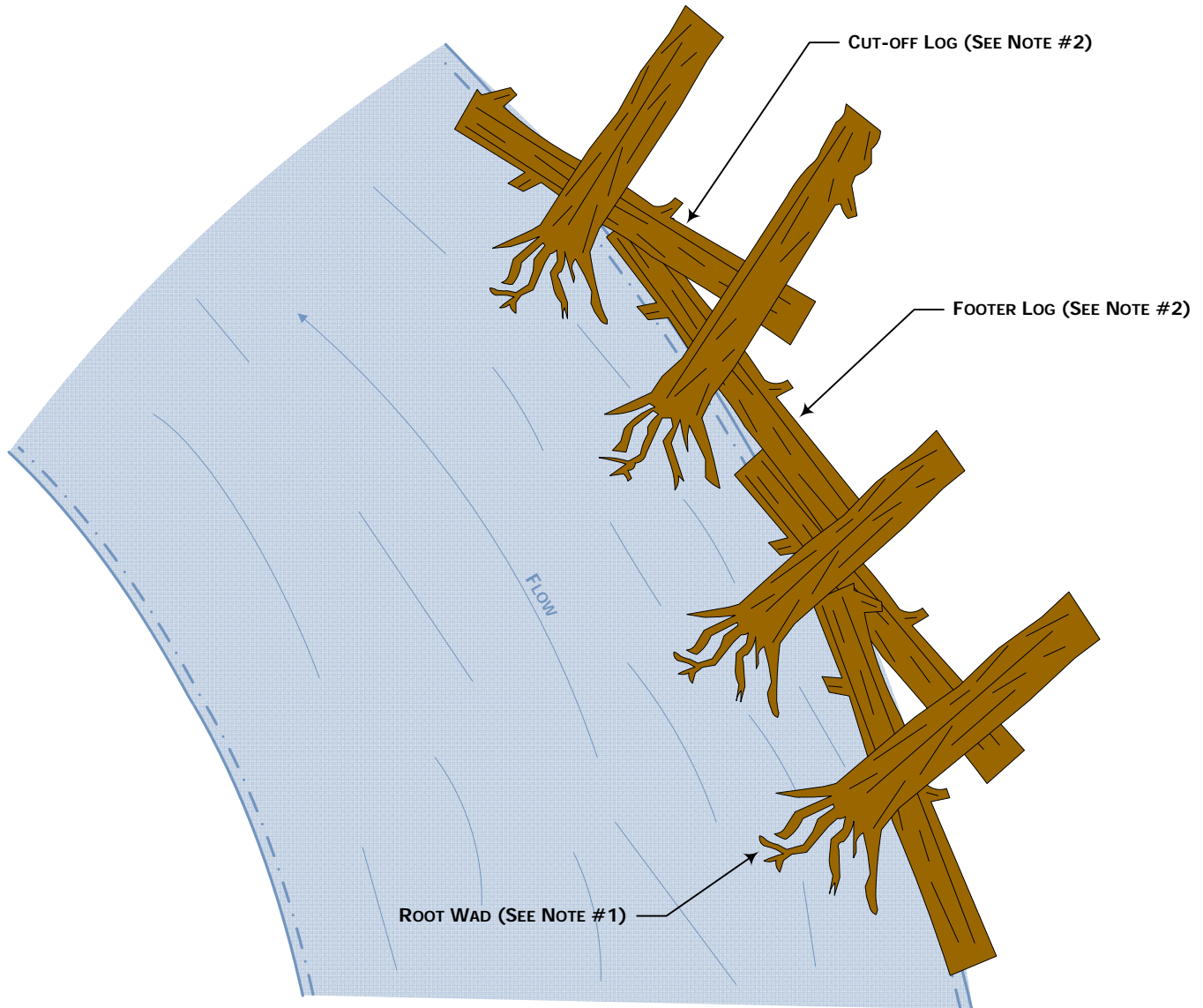

Notes:

#1 – Root wad logs to be used on steep banks or based on agency recommendations.

#2 - Root wad logs to be anchored appropriately based on site-specific conditions or agency recommendations.

Appendix A

Noxious and Invasive Weed Species

Appendix A

Sandpiper Pipeline Project Noxious and Invasive Weed Species				
State/Weed Type	Common Name	Scientific Name	Regulatory Classification	
NORTH DAKOTA				
Terrestrial Weeds	Russian knapweed	<i>Acroptilon repens</i>	NW ^a	
	absinth wormwood	<i>Artemisia absinthium</i>	NW ^a	
	musk thistle	<i>Carduus nutans</i>	NW ^a	
	diffuse knapweed	<i>Centaurea diffusa</i>	NW ^a	
	yellow starthistle	<i>Centaurea solstitialis</i>	NW ^a	
	spotted knapweed	<i>Centaurea stoebe</i> ; <i>Centaurea maculosa</i>	NW ^a	
	Canada thistle	<i>Cirsium arvense</i>	NW ^a	
	field bindweed	<i>Convolvulus arvensis</i>	NW ^a	
	leafy spurge	<i>Euphorbia esula</i>	NW ^a	
	Dalmatian toadflax	<i>Linaria dalmatica</i> ; <i>Linaria genistifolia</i>	NW ^a	
	purple loosestrife	<i>Lythrum salicaria</i> ; <i>Lythrum virgatum</i>	NW ^a	
	saltcedar	<i>Tamarix chinensis</i> ; <i>Tamarix parviflora</i> ; <i>Tamarix ramosissima</i>	NW ^a	
	Mountrail County	common tansy	<i>Tanacetum vulgare</i>	CONW ^a
		houndstounge	<i>Cynoglossum officinale</i>	CONW ^a
	Ward County	scentless chamomile	<i>Anthemis arvensis</i>	CONW ^a
	yellow toadflax	<i>Linaria vulgaris</i>	CONW ^a	
	houndstounge	<i>Cynoglossum officinale</i>	CONW ^a	
Ramsey County	annual sowthistle	<i>Sonchus oleraceus</i>	CONW ^a	
	scentless chamomile	<i>Anthemis arvensis</i>	CONW ^a	
	common milkeed	<i>Asclepias syriaca</i>	CONW ^a	
Nelson County	perennial sowthistle	<i>Sonchus arvensis</i>	CONW ^a	
Grand Forks County	kochia	<i>Bassia scoparia</i>	CONW ^a	
Aquatic Weeds	curly leaf pondweed	<i>Potamogeton crispus</i>	Regulated	
	Eurasian watermilfoil	<i>Myriophyllum spicatum</i>	Regulated	
	didymo or rock snot	<i>Didymosphenia geminata</i>	Prohibited	
Aquatic Invertebrate Invasives (Bivalves)	Asian clam	<i>Corbicula fluminea</i>	Prohibited	
	Zebra mussel	<i>Dreissena polymorpha</i>	Prohibited	
	Quagga mussel	<i>Dreissena bugensis</i>	Prohibited	
	New Zealand mudsnail	<i>Potamopyrgus antipodarum</i>	Prohibited	
	Rusty crayfish	<i>Orconectes rusticus</i>	Prohibited	
Aquatic Invertebrate Invasives	Scud	<i>Echinogammarus ischnus</i>	Prohibited	
	Fishhook water flea	<i>Cercopagis pengoi</i>	Prohibited	
	Spiny water flea	<i>Bythotrephes cederstroemi</i>	Prohibited	
MINNESOTA				
Terrestrial Weeds	black swallow-wort	<i>Cynanchum louiseae</i>	SN ^b	
	brown knapweed	<i>Centaurea jacea</i>	SN ^b	
	Canada thistle	<i>Cirsium arvense</i>	SN, PS ^c	
	common or European buckthorn	<i>Rhamnus cathartica</i>	RN ^d	
	common reed – non-native subspecies	<i>Phragmites australis</i>	RN ^d	

Sandpiper Pipeline Project			
Noxious and Invasive Weed Species			
State/Weed Type	Common Name	Scientific Name	Regulatory Classification
	common teasel	<i>Dipsacus fullonum</i>	SN ^b
	Cut-leaved teasel	<i>Dipsacus laciniatus</i>	SN ^b
	Dalmatian toadflax	<i>Linaria dalmatica</i>	SN ^b
	garlic mustard	<i>Alliaria petiolata</i>	SN ^c
	giant hogweed	<i>Heracleum mantegazzianum</i>	FN ^b
	glossy buckthorn, including all cultivars	<i>Frangula alnus</i>	RN ^d
	Grecian foxglove	<i>Digitalis lanata</i>	PS ^b
	Japanese hops	<i>Humulus japonicus</i>	SN ^b
	leafy spurge	<i>Euphorbia esula</i>	SN, PS ^c
	meadow knapweed	<i>Centaurea x moncktonii</i>	FN ^b
	multiflora rose	<i>Rosa multiflora</i>	RN ^d
	musk thistle	<i>Carduus nutans</i>	SN, PS ^c
	narrowleaf bittercress	<i>Cardamine impatiens</i>	SN ^c
	Oriental bittersweet	<i>Celastrus orbiculatus</i>	SN ^b
	plumeless thistle	<i>Carduus acanthoides</i>	SN, PS ^c
	purple loosestrife	<i>Lythrum salicaria, virgatum</i>	SN ^c
	spotted knapweed	<i>Centaurea stoebe</i>	SN ^c
	common tansy	<i>Tanacetum vulgare</i>	SN ^c
	wild parsnip	<i>Pastinaca sativa</i>	SN ^c
	yellow starthistle	<i>Centaurea solstitialis</i>	PI ^b
Aquatic Weeds	African oxygen weed	<i>Lagarosiphon major</i>	FN, PI; Prohibited Species
	ambulia	<i>Limnophila sessiliflora</i>	FN
	anchored or rooted water hyacinth	<i>Eichornia azurea</i>	FN
	aquarium watermoss, giant salvinia	<i>Salvinia molesta</i>	FN; Prohibited Species
	arrowhead	<i>Sagittaria sagittifolia</i>	FN
	arrowleaf false pickerelweed	<i>Monochoria hastata</i>	FN
	Australian stonecrop	<i>Crassula helmsii</i>	PI; Prohibited Species
	brittle naiad	<i>Najas minor</i>	PI; Prohibited Species
	broadleaf paper bark tree	<i>Melaleuca quinquinervia</i>	FN
	curly-leaf pondweed	<i>Potamogeton crispus</i>	PI; Prohibited Species
	European frog-bit	<i>Hydrocharis morsus-ranae</i>	PI; Prohibited Species
	Eurasian watermilfoil	<i>Myriophyllum spicatum</i>	PI; Prohibited Species
	exotic bur-reed	<i>Sparganium erectum</i>	FN
	ducklettuce	<i>Ottelia alismoides</i>	FN
	flowering rush	<i>Butomus umbellatus</i>	PE; Prohibited Species
	giant salvinia	<i>Salvinia auriculata</i>	FN
	giant salvinia	<i>Salvinia biloba</i>	FN
	giant salvinia	<i>Salvinia herzogii</i>	FN
	heart-shaped false pickerelweed	<i>Monochoria vaginalis</i>	FN
	hydrilla	<i>Hydrilla verticillata</i>	FN, PI; Prohibited Species
	Indian swampweed, Miramar weed	<i>Hygrophila polysperma</i>	FN; Prohibited Species

Sandpiper Pipeline Project			
Noxious and Invasive Weed Species			
State/Weed Type	Common Name	Scientific Name	Regulatory Classification
	Mediterranean strain (killer algae)	<i>Caulerpa taxifolia</i>	FN
	mosquito fern, water velvet	<i>Azolla pinnata</i>	FN
	purple loosestrife	<i>Lythrum salicaria</i> , <i>Lythrum virgatum</i>	PI, SN; Prohibited Species
	water aloe or water soldiers	<i>Stratiotes aloides</i>	PI; Prohibited Species
	water chestnut	<i>Trapa natans</i>	PI; Prohibited Species
	water-spinach, swamp morning-glory	<i>Ipomoea aquatica</i>	FN
	wetland nightshade	<i>Solanum tampicense</i>	FN
	Brazilian waterweed	<i>Egeria densa</i>	Regulated Species
	Carolina fanwort or fanwort	<i>Cabomba caroliniana</i>	Regulated Species
	Chinese water spinach	<i>Ipomoea aquatica</i>	Regulated Species
	nonnative waterlilies	<i>Nymphaea spp.</i>	Regulated Species
	parrot's feather	<i>Myriophyllum aquaticum</i>	Regulated Species
	yellow iris or yellow flag	<i>Iris pseudacoris</i>	Regulated Species
Aquatic Invertebrate Invasives	faucet snail	<i>Bithynia tentaculata</i>	Prohibited Species
	New Zealand mud snail	<i>Potamopyrgus antipodarum</i>	Prohibited Species
	quagga mussel	<i>Dreissena bugensis</i>	Prohibited Species
	red swamp crayfish	<i>Procambarus clarkii</i>	Prohibited Species
	zebra mussel	<i>Dreissena spp.</i>	Prohibited Species
	Banded mystery snail	<i>Viviparus georgianus</i>	Regulated Species
	Chinese mystery snail, Japanese trap door snail	<i>Cipangopaludina spp.</i>	Regulated Species
	rusty crayfish	<i>Orconectes rusticus</i>	Regulated Species
	spiny water flea	<i>Bythotrephes longimanus</i>	Regulated Species
WISCONSIN			
Terrestrial Weeds	Amur honeysuckle	<i>Lonicera maackii</i>	Prohibited/Restricted
	Autumn olive	<i>Elaeagnus umbellata</i>	Restricted
	Bells honeysuckle	<i>Lonicera x bella</i>	Restricted
	Black swallow-wort	<i>Vincetoxicum nigrum</i>	Prohibited/Restricted
	Canada thistle	<i>Cirsium arvense</i>	Restricted
	Cattail hybrid	<i>Typha x glauca</i>	Restricted
	Celandine	<i>Chelidonium majus</i>	Prohibited/Restricted
	Chinese yam	<i>Dioscorea oppositifolia</i>	Prohibited
	Common buckthorn	<i>Rhamnus cathartica</i>	Restricted
	Common teasel	<i>Dipsacus fullonum subsp. sylvestris</i>	Restricted
	Creeping bellflower	<i>Campanula rapunculoides</i>	Restricted
	Cut-leaved teasel	<i>Dipsacus laciniatus</i>	Restricted
	Cypress spurge	<i>Euphorbia cyparissias</i>	Restricted
	Cypress spurge	<i>Euphorbia cyparissias</i>	Restricted
	European marsh thistle	<i>Cirsium palustre</i>	Prohibited/Restricted

Sandpiper Pipeline Project			
Noxious and Invasive Weed Species			
State/Weed Type	Common Name	Scientific Name	Regulatory Classification
	Garlic mustard	<i>Alliaria petiolata</i>	Restricted
	Giant hogweed	<i>Heracleum mantegazzianum</i>	Prohibited
	Giant knotweed	<i>Polygonum sachalinense</i>	Prohibited
	Glossy buckthorn	<i>Frangula alnus</i>	Restricted
	Hairy willow herb	<i>Epilobium hirsutum</i>	Prohibited/Restricted
	Helleborine orchid	<i>Epipactis helleborine</i>	Restricted
	Hemp nettle, brittlestem hemp nettle	<i>Galeopsis tetrahit</i>	Restricted
	Hill mustard	<i>Bunias orientalis</i>	Prohibited/Restricted
	Hound's tongue	<i>Cynoglossum officinale</i>	Restricted
	Japanese hedge- parsley	<i>Torilis japonica</i>	Prohibited/Restricted
	Japanese honeysuckle	<i>Lonicera japonica</i>	Prohibited
	Japanese hops	<i>Humulus japonicus</i>	Prohibited/Restricted
	Japanese knotweed	<i>Polygonum cuspidatum</i>	Restricted
	Japanese stilt grass	<i>Microstegium vimineum</i>	Prohibited
	Kudzu	<i>Pueraria lobata</i>	Prohibited
	Leafy spurge	<i>Euphorbia esula</i>	Restricted
	Lyme grass or sand ryegrass	<i>Leymus arenarius</i>	Prohibited/Restricted
	Mile-a-minute vine	<i>Polygonum perfoliatum</i>	Prohibited
	Morrow's honeysuckle	<i>Lonicera morrowii</i>	Restricted
	Multiflora rose	<i>Rosa multiflora</i>	Restricted
	Musk thistle	<i>Carduus nutans</i>	Restricted
	Narrow-leaf cattail	<i>Typha angustifolia</i>	Restricted
	Oriental bittersweet	<i>Celastrus orbiculatus</i>	Restricted
	Pale swallow-wort	<i>Vincetoxicum rossicum</i>	Prohibited
	Perennial pepperweed	<i>Lepidium latifolium</i>	Prohibited
	Phragmites, Common reed	<i>Phragmites australis</i>	Restricted
	Plumeless thistle	<i>Carduus acanthoides</i>	Restricted
	Poison hemlock	<i>Conium maculatum</i>	Prohibited/Restricted
	Porcelain berry	<i>Ampelopsis brevipedunculata</i>	Prohibited
	Princess tree	<i>Paulownia tomentosa</i>	Prohibited
	Purple loosestrife	<i>Lythrum salicaria</i>	Restricted
	Russian olive	<i>Elaeagnus angustifolia</i>	Restricted
	Sawtooth oak	<i>Quercus acutissima</i>	Prohibited
	Scotch broom	<i>Cytisus scoparius</i>	Prohibited
	Sericea lespedeza	<i>Lespedeza cuneata</i>	Prohibited
	Spotted knapweed	<i>Centaurea biebersteinii, c. stoebe</i>	Restricted
	Spreading hedge parsley	<i>Torilis arvensis</i>	Prohibited
	Tall or Reed manna grass	<i>Glyceria maxima</i>	Prohibited/Restricted
	Tansy	<i>Tanacetum vulgare</i>	Restricted

Sandpiper Pipeline Project			
Noxious and Invasive Weed Species			
State/Weed Type	Common Name	Scientific Name	Regulatory Classification
Wetland Weeds	Tartarian honeysuckle	<i>Lonicera tatarica</i>	Restricted
	Tree-of-heaven	<i>Ailanthus altissima</i>	Restricted
	Wild chervil	<i>Anthriscus sylvestris</i>	Prohibited/Restricted
	Wild parsnip	<i>Pastinaca sativa</i>	Restricted
	Wineberry	<i>Rubus phoenicolasius</i>	Prohibited
	Yellow star thistle	<i>Centaurea solstitialis</i>	Prohibited
	Dame's rocket	<i>Hesperis matronalis</i>	Restricted
	European marsh thistle	<i>Cirsium palustre</i>	Prohibited/Restricted
Aquatic Weeds	Flowering rush	<i>Butomus umbellatus</i>	Restricted
	Australian swamp crop	<i>Crassula helmsii</i>	Prohibited
	Brazilian waterweed	<i>Egeria densa</i>	Prohibited
	Brittle waternymph	<i>Najas minor</i>	Prohibited
	Curly-leaf pondweed	<i>Potamogeton crispus</i>	Restricted
	Eurasian water milfoil	<i>Myriophyllum spicatum</i>	Restricted
	European frog-bit	<i>Hydrocharis morsus-ranae</i>	Prohibited
	Fanwort, Carolina Fanwort	<i>Cabomba caroliniana</i>	Prohibited
	Flowering rush	<i>Butomus umbellatus</i>	Restricted
	Hydrilla	<i>Hydrilla verticillata</i>	Prohibited
	Oxygen-weed, African elodea	<i>Lagarosiphon major</i>	Prohibited
	Parrot feather	<i>Myriophyllum aquaticum</i>	Prohibited
	Water chestnut	<i>Trapa natans</i>	Prohibited
	Yellow floating heart	<i>Nymphoides peltata</i>	Prohibited
	N/A	<i>Ulva (Enteromorpha) spp.</i>	Prohibited
Aquatic Fish and Invertebrate Invasives	Asian clam	<i>Corbicula fluminea</i>	Prohibited
	Bloody shrimp	<i>Hemimysis anomala</i>	Prohibited
	Chinese mitten crabs	<i>Eriocheir sinensi</i>	Prohibited
	Chinese mystery snail	<i>Cipangopaludina chinensis</i>	Restricted
	Cylindro (cyanobacteria)	<i>Cylindrospermopsis raciborskii</i>	Prohibited
	Didymo or rock snot	<i>Didymosphenia geminata</i>	Prohibited
	Faucet snail	<i>Bithynia tentaculata</i>	Prohibited
	Fishhook waterflea	<i>Cercopagis pengoi</i>	Prohibited
	Golden alga	<i>Prymneisum parvum</i>	Prohibited
	New Zealand mudsnail	<i>Potamopyrgus antipodarum</i>	Prohibited
	Novel cyanobacterial epiphyte of order Stigonematales	<i>Stigonematales spp.</i>	Prohibited
	Quagga mussels	<i>Dreissena bugensis</i>	Prohibited
	Red swamp crayfish	<i>Procambarus clarkii</i>	Prohibited
	Rusty crayfish	<i>Orconectes rusticus</i>	Restricted
	Spiny waterflea	<i>Bythotrephes cederstroemi</i>	Prohibited
Starry stonewort (alga)	<i>Nitellopsis obtusa</i>	Prohibited	

Sandpiper Pipeline Project Noxious and Invasive Weed Species			
State/Weed Type	Common Name	Scientific Name	Regulatory Classification
	Water flea	<i>Daphnia lumholtzi</i>	Prohibited
	Zebra mussel	<i>Dreissena polymorpha</i>	Restricted
<p>North Dakota: ^a Listed Regulated Species</p> <p>Minnesota Control Status: ^b Eradicate ^c Control ^d Restricted</p> <p>Abbreviations: NW = Noxious Weed CONW = County Noxious Weed SN = State noxious weed (Minnesota Department of Agriculture) PS = State prohibited weed seed (Minnesota Department of Agriculture) RN = Restricted noxious weed (Minnesota Department of Agriculture) FN = Federal noxious weed (USDA-Animal Plant Health Inspection Service) PI = Prohibited exotic species (Minnesota Department of Natural Resources)</p>			

Appendix B
Equipment Cleaning Log



Equipment Cleaning Log

Form Completed By: _____

Date: _____ Time: _____

Location of Equipment (tract & milepost): _____

Equipment Type: _____

Equipment ID (e.g., company, unique ID number): _____

Cleaning Method: (check all that apply)

- Scrape Down
- Steam Wash Blow Down (compressed air)
- Power/Pressure Wash (water)
- Other (Describe): _____

Comments: _____

Appendix C

Seed Mixes

**Sandpiper Pipeline Project
Seed Mixes**

Table 1 – North Dakota, Minnesota, and Wisconsin Temporary Cover Crop Seed Mix

Seed Name	Pure Live Seed (Pounds Per Acre)	% of Seed
Oats <i>if summer seeding</i> (<i>Avena sativa</i>) OR Winter Wheat <i>if dormant (late fall) or spring seeding</i> (<i>Triticum aestivum</i>)	40	50%
Annual Ryegrass (<i>Lolium italicum</i>), Annual Alfalfa (<i>Medicago sativa</i>), or Slender Wheat Grass (<i>Elymus trachycaulus</i>)	40	50%
GRAND TOTAL	80 pounds	100%

Table 2 – North Dakota Construction Area Standard Upland Seed Mix

Seed Name	Pure Live Seed (Pounds Per Acre)	% of Seed
Western Wheatgrass (<i>Pascopyrum smithii</i>)	3.2	20%
Slender Wheatgrass (<i>Elymus trachycaulus</i>)	1	10%
NewHy bluebunch-quackgrass hybrid	6	30%
Pubescent Wheatgrass (<i>Elytrigia intermedia</i>)	5.2	30%
Alfalfa	1.2	10%
<i>Total</i>	16.6	100%
Associated Companion Crop Mix		
Oats <i>if summer seeding</i> (<i>Avena sativa</i>) or Winter Wheat <i>if late fall (dormant) or spring seeding</i> (<i>Triticum aestivum</i>)	16	80%
Annual Ryegrass (<i>Lolium italicum</i>), or Slender Wheat Grass (<i>Elymus trachycaulus</i>)	4	20%
<i>Companion/Cover Crop Total</i>	20	100%
GRAND TOTAL	36.6 pounds	100%

**Sandpiper Pipeline Project
Seed Mixes**

Table 3 – Minnesota and Wisconsin Construction Area Standard Upland Seed Mix

Seed Name	Pure Live Seed (Pounds Per Acre)	% of Seed
Perennial Ryegrass <i>(Lolium perenne)</i>	2	17%
Canada Wild-rye <i>(Elymus canadensis)</i>	4	33%
Switchgrass <i>(Panicum virgatum)</i> (unimproved native variety)	4	33%
Timothy <i>(Phleum pratense)</i>	2	17%
<i>Total</i>	12	100%
Associated Companion Crop Mix		
Oats <i>if summer seeding (Avena sativa)</i> or Winter Wheat <i>if late fall (dormant) or spring seeding (Triticum aestivum)</i>	16	80%
Annual Ryegrass <i>(Lolium italicum)</i> , OR Slender Wheat Grass <i>(Elymus trachycaulus)</i>	4	20%
<i>Companion/Cover Crop Total</i>	20	100%
GRAND TOTAL	32 pounds	100%

Table 4- North Dakota, Minnesota, and Wisconsin Unsaturated Wetland Seed Mix – General Restoration Mix

Seed Name	Pure Live Seed (Pounds Per Acre)	Percent (%) of Seed
American Slough Grass <i>(Beckmannia syzigachne)</i>	6	30%
Annual Rye Grass <i>(Lolium perene)</i>	8	40%
Fowl Bluegrass <i>(Poa palustris)</i>	6	30%
GRAND TOTAL	20.0 pounds	100%

Table 5 – North Dakota, Minnesota, and Wisconsin Residential Area Upland Seed Mix

Seed Name	Pure Live Seed (Pounds Per Acre)	% of Seed
Kentucky Bluegrass <i>(Poa pratensis)</i>	82.5	52%
Perennial Ryegrass <i>(Lolium perenne)</i>	30	19%
Creeping Red Fescue <i>(Festuca rubra)</i>	37.5	23%
Annual Rye Grass <i>(Lolium italicum)</i>	10	6%
GRAND TOTAL	160 pounds	100%

**Sandpiper Pipeline Project
Seed Mixes**

Table 6 – North Dakota Livestock Grazing and Hay Production Areas Upland Seed Mix

Seed Name	Pure Live Seed (Pounds Per Acre)	% of Seed
Western Wheatgrass (<i>Pascopyrum smithii</i>)	3.2	20%
Slender Wheatgrass (<i>Elymus trachycaulus</i>)	1	10%
NewHy bluebunch-quackgrass hybrid	6	30%
Pubescent Wheatgrass (<i>Elytrigia intermedia</i>)	5.2	30%
Alfalfa	1.2	10%
<i>Total</i>	16.6	100%
Associated Companion Crop Mix		
Oats <i>if summer seeding</i> (<i>Avena sativa</i>) or Winter Wheat <i>if late fall (dormant) or spring seeding</i> (<i>Triticum aestivum</i>)	16	80%
Annual Ryegrass (<i>Lolium italicum</i>), or Slender Wheat Grass (<i>Elymus trachycaulus</i>)	4	20%
Companion/Cover Crop Total	20	100%
GRAND TOTAL	36.6 pounds	100%

Table 7 – Minnesota and Wisconsin Livestock Grazing and Hay Production Areas Upland Seed Mix

Seed Name	Pure Live Seed (Pounds Per Acre)	% of Seed
Orchard Grass (<i>Dactylis glomerata</i>)	6	30%
Vernal Alfalfa (<i>Medicago sativa</i>)	2	10%
Climax Timothy (<i>Phleum pratense</i>)	3	15%
Tetraploid Perennial Ryegrass (<i>Lolium perenne</i>)	4	20%
Alsike Clover (<i>Trifolium hybridum</i>)	2	10%
Medium Red Clover (<i>Trifolium pratense</i>)	3	15%
<i>Total</i>	20	100%
Associated Cover Crop Mix		
Oats <i>if summer seeding</i> (<i>Avena sativa</i>) or Winter Wheat <i>if late fall (dormant) or spring seeding</i> (<i>Triticum aestivum</i>)	16	80%
Annual Ryegrass (<i>Lolium italicum</i>), or Slender Wheat Grass (<i>Elymus trachycaulus</i>)	4	20%
Cover Crop Total	20	100%
GRAND TOTAL	40 pounds	100%

**Sandpiper Pipeline Project
Seed Mixes**

Table 8 – North Dakota Wildlife Area Upland Seed Mix

Seed Name	Pure Live Seed (Pounds Per Acre)	% of Seed
Western Wheatgrass (<i>Pascophyrum smithii</i>)	4.0	34.5%
Slender Wheatgrass (<i>Elymus trachycaulus</i>)	1.0	8.6%
Green needlegrass (<i>Stipa viridula</i>)	2.4	20.7%
Sideoats grama (<i>Bouteloua curtipendula</i>)	2.4	20.7%
Blue grama (<i>Bouteloua gracilis</i>)	0.4	3.4%
Canada wildrye (<i>Elymus Canadensis</i>)	0.6	5.2%
Switchgrass (<i>Panicum virgatum</i>)	0.8	6.9%
GRAND TOTAL	11.6 pounds	100%

Table 9 – Minnesota and Wisconsin Wildlife Area Upland Seed Mix

Seed Name	Pure Live Seed (Pounds Per Acre)	% of Seed
Red Clover (<i>Trifolium pretense</i>)	4.5	30%
Alsike Clover (<i>Trifolium hybridum</i>)	4.5	30%
White Clover (<i>Trifolium repens</i>)	4.5	30%
Creeping Red Fescue (<i>Festuca rubra</i>)	1.5	10%
<i>Total</i>	15	100%
Associated Cover Crop Mix		
Oats if summer seeding (<i>Avena sativa</i>) or Winter Wheat if spring seeding (<i>Triticum aestivum</i>)	16	80%
Annual Ryegrass (<i>Lolium italicum</i>), Annual Alfalfa (<i>Medicago sativa</i>), or Slender Wheat Grass (<i>Elymus trachycaulus</i>)	4	20%
<i>Cover Crop Total</i>	20	100%
GRAND TOTAL	35 pounds	100%

**Sandpiper Pipeline Project
Seed Mixes**

Table 10 – North Dakota Native Area Seed Mix

Seed Name	Pure Live Seed (Pounds Per Acre)	% of Seed
Western Wheatgrass (<i>Pascopyrum smithii</i>)	4.0	34.5%
Slender Wheatgrass (<i>Elymus trachycaulus</i>)	1.0	8.6%
Green needlegrass (<i>Stipa viridula</i>)	2.4	20.7%
Sideoats grama (<i>Bouteloua curtipendula</i>)	2.4	20.7%
Blue grama (<i>Bouteloua gracilis</i>)	0.4	3.4%
Canada wildrye (<i>Elymus Canadensis</i>)	0.6	5.2%
Switchgrass (<i>Panicum virgatum</i>)	0.8	6.9%
GRAND TOTAL	11.6	100%

Table 11 – Minnesota and Wisconsin Native Area Seed Mix ^{1/}

Seed Name	Pure Live Seed (Pounds Per Acre)	% of Seed
Big Bluestem (<i>Andropogon gerardi</i>)	4	44%
Western Wheatgrass (<i>Pascopyrum smithii</i>)	4	29%
Switchgrass (<i>Panicum virgatum</i>)	0.5	12%
Canada Wildrye (<i>Elymus canadensis</i>)	2	15%
Purple Prairie Clover (<i>Dalea purpureum</i>)	2 (ounces)	
<i>Total</i>	10.5 pounds	100%
Associated Cover Crop Mix		
Oats <i>if summer seeding</i> (<i>Avena sativa</i>) or Winter Wheat <i>if spring seeding</i> (<i>Triticum aestivum</i>)	16	80%
Slender Wheat Grass (<i>Elymus trachycaulus</i>)	4	20%
<i>Cover Crop Total</i>	20	100%
GRAND TOTAL	30.5 pounds	100%
1/ Applicable seeding dates: May 15 to June 30 or after soil temperatures are below 55 degrees Fahrenheit.		

**Sandpiper Pipeline Project
Seed Mixes**

Table 12 – North Dakota Roadside Seed Mix

Seed Name	Pure Live Seed (Pounds Per Acre)	% of Seed
Western Wheatgrass (<i>Pascopyrum smithii</i>)	3.2	20%
Slender Wheatgrass (<i>Elymus trachycaulus</i>)	1	10%
NewHy bluebunch-quackgrass hybrid	6	30%
Pubescent Wheatgrass (<i>Elytrigia intermedia</i>)	5.2	30%
Alfalfa	1.2	10%
<i>Total</i>	16.6	100%
Associated Companion Crop Mix		
Oats <i>if summer seeding</i> (<i>Avena sativa</i>) or Winter Wheat <i>if late fall</i> (<i>dormant</i>) or <i>spring seeding</i> (<i>Triticum aestivum</i>)	16	80%
Annual Ryegrass (<i>Lolium italicum</i>), or Slender Wheat Grass (<i>Elymus trachycaulus</i>)	4	20%
<i>Companion/Cover Crop Total</i>	20	100%
GRAND TOTAL	36.6 pounds	100%

**Sandpiper Pipeline Project
Seed Mixes**

Table 13 – Minnesota and Wisconsin Roadside Seed Mix

Seed Name	Pure Live Seed (Pounds Per Acre)	% of Seed
Kentucky Bluegrass – Certified Park (<i>Poa pratensis</i>)	22.3	32%
Canada Bluegrass (<i>Poa compressa</i>)	9.8	14%
Switch grass (<i>Panicum virgatum</i>)	2.1	3%
Slender Wheatgrass (<i>Elymus trachycaulus</i>)	2.8	4%
Perennial Rye-grass (<i>Lolium perenne</i>)	14.7	21%
Timothy (<i>Phleum pratense</i>)	2.1	3%
Redtop (<i>Agrostis gigantea</i>)	2.1	3%
Creeping Alfalfa (<i>Medicago sativa</i>)	4.2	6%
White clover (<i>Trifolium repens</i>)	2.1	3%
Hairy Vetch (<i>Vicia villosa</i>)	7.8	11%
<i>Total</i>	70 pounds	100%
Associated Cover Crop Mix		
Oats if summer seeding (<i>Avena sativa</i>) or Winter Wheat if spring seeding (<i>Triticum aestivum</i>)	16	80%
Annual Ryegrass (<i>Lolium italicum</i>), Annual Alfalfa (<i>Medicago sativa</i>), or Slender Wheat Grass (<i>Elymus trachycaulus</i>)	4	20%
<i>Cover Crop Total</i>	20	100%
GRAND TOTAL	90 pounds	100%

Table 14 – North Dakota Conservation Reserve Program (CRP) Seed Mix

Seed Name	Pure Live Seed (Pounds Per Acre)	% of Seed
Tall wheat grass (<i>Thinopyrum ponticum</i>)	2.2	27.5
Intermediate or pubescent wheat grass (<i>Thinopyrum intermedium</i>)	4.3	53.75
Alfalfa (<i>Medicago sativa</i>)	1.1	13.75
Sweet clover (<i>Melilotus officinalis</i>)	0.4	5
GRAND TOTAL	8 pounds	100%

**Sandpiper Pipeline Project
Seed Mixes**

Table 15 – Minnesota Protected Waters Seed Mix¹

Seed Name	Pure Live Seed (Pounds Per Acre)	% of Seed
American slough grass (<i>Beckmannia syzigachne</i>)	1.5	18.63%
Blue-joint grass (<i>Calamagrostis Canadensis</i>)	0.06	0.75%
Reed manna grass (<i>Glyceria grandis</i>)	0.18	2.24%
Fowl manna grass (<i>Glyceria grandis</i>)	0.12	1.49%
Rice Cut-grass (<i>Leersia oryzoides</i>)	0.24	2.98%
Annual ryegrass (<i>Lolium italicum</i>)	0.9	11.18%
Fowl bluegrass (<i>Poa palustris</i>)	1.8	22.36%
Tussock sedge (<i>Carex stricta</i>)	0.06	0.75%
Fox sedge (<i>Carex vulpinoidea</i>)	0.3	3.37%
Green bulrush (<i>Scirpus atrovirens</i>)	0.06	0.75%
Wool grass (<i>Scirpus cyperinus</i>)	0.006	0.07%
River bulrush (<i>Scirpus fluviatilis</i>)	0.24	2.98%
Soft-stem bulrush (<i>Scirpus validus</i>)	0.12	1.49%
Marsh milkweed (<i>Asclepias incarnate</i>)	0.12	1.49%
Flat-topped aster (<i>Aster umbellatus</i>)	0.3	3.73%
Joe-pye weed (<i>Eupatorium maculatum</i>)	0.3	3.73%
Boneset (<i>Eupatorium perfoliatum</i>)	0.24	2.98%
Sneezeweed (<i>Helenium autumnale</i>)	0.24	2.98%
Spotted Touch-me-not (<i>Impatiens capensis</i>)	0.06	0.75%
Great-blue lobelia (<i>Lobelia siphilitica</i>)	0.12	1.49%
Monkey flower (<i>Mimulus ringens</i>)	0.006	0.07%
Mountain mint (<i>Pycnanthemum virginianum</i>)	0.12	1.49%
Giant goldenrod (<i>Solidago gigantea</i>)	0.24	2.98%
Blue vervain (<i>Verbena hastate</i>)	0.36	4.47%
Ironweed (<i>Veronia fasciculata</i>)	0.36	4.47%
<i>Total</i>	6.0	100%
Associated Cover Crop Mix		
Slender Wheat Grass (<i>Elymus trachycaulus</i>)	2	100%
<i>Cover Crop Total</i>	2	100%
GRAND TOTAL	8 pounds	100%
¹ Applicable seeding dates: May 15 to June 30 or after soil temperatures are below 55 degrees Fahrenheit. ² Quantities and availability may be limited.		

**Sandpiper Pipeline Project
Seed Mixes**

Table 16 – North Dakota Park and Recreation Department - Suggested grass/forb mix for Restoration of the Northern Tallgrass Prairie

The following is a suggested mix for the restoration project. This mix matches the typical plant species found within the Northern Tallgrass Prairie plant community.

Grass Species	Common Name
<i>*Andropogon gerardii</i>	Big bluestem
<i>*Panicum virgatum</i>	Switchgrass
<i>*Calamagrostis canadensis</i>	Bluejoint
<i>*Calamagrostis stricta</i>	Slimsteam reedgrass
<i>*Spartina pectinata</i>	Prairie cordgrass
<i>Koeleria macrantha</i>	Prairie junegrass
<i>Bouteloua curtipendula</i>	Sideoats grama
<i>Nassella viridula</i>	Green needlegrass
<i>Pascopyrum smithii</i>	Western wheatgrass
Forb Species	Common Name
<i>Achillea millefolium</i>	Common yarrow
<i>Anemone Canadensis</i>	Canadian anemone
<i>Artemisia ludoviciana</i>	White sagebrush
<i>Pediomelum argophyllum</i>	Silvery scurfpea
<i>Rudbeckia hirta</i>	Blackeyed susan
<i>Polygala verticillata</i>	Milkwort
<i>Ratibida columnifera</i>	Prairie coneflower
<i>Solidago Canadensis</i>	Canada goldenrod
<i>Symphyotrichum ericoides</i>	White heath aster
<i>Vicia americana</i>	American vetch
<i>Dalea purpurea</i>	Purple prairie clover

*Indicates dominates within this plant community.

Regarding: Wet-Mesic Tallgrass Prairie

Community Description

Andropogon gerardii - (*Panicum virgatum*) - *Muhlenbergia richardsonis* Herbaceous Vegetation

Translated Name: Big Bluestem - (Switchgrass) - Mat Muhly Herbaceous Vegetation

Common Name: Northern Wet-Mesic Tallgrass Prairie

Unique Identifier: CEG002199

Classification Approach: International Vegetation Classification (IVC)

Summary: This big bluestem wet-mesic prairie type is found in the northern tallgrass prairie region of the United States and Canada. In South Dakota, soils are moist loams and poorly drained silt loams derived from glacial drift. The vegetation is dominated by a dense layer of tall grasses, such as *Andropogon gerardii* and *Panicum virgatum*, with associates of *Calamagrostis canadensis*, *Calamagrostis stricta*, and *Spartina pectinata*. *Muhlenbergia richardsonis* may be a diagnostic, less dominant species of the northern tallgrass prairie. In the Sheyenne Delta, this type may form a distinctive wet-mesic sand prairie type.

Appendix D

EPND Environment Hydrotest Discharge Authorization and Documentation

The purpose of this form is to document and insure that appropriate planning occurs prior to hydrostatic test discharge activities as well as the proper recording of necessary information during the actual discharge event. If the discharge permit specifies the need for a Certified Operator, he/she is responsible for the final section of the form. Otherwise, an Environmental Inspector will be responsible for completion of this form.

Part 1: Basic Discharge Information: All information must be completed. Coordination with Enbridge Engineering is necessary to obtain the exact test section length and volume of water to be discharged. The estimated duration of the discharge must be calculated using the maximum permitted rate (or the anticipated rate, if lower than the permitted rate) and the total volume of water to be discharged. This is critical information and will ensure that any required sampling is conducted at the appropriate frequency specified in the permit.

Part 2: Pre-Discharge Planning Checklist: A pre-discharge planning meeting must be held with the Certified Operator (if required), Contractor, Craft Inspection, Environmental Inspection, and Construction Management staff to review items included in the checklist and any other pertinent information deemed necessary. A full copy of the permit and discharge plan must be provided to all participants. Upon completion of this meeting, all participants must sign the form to indicate that they understand all steps of the discharge process. **Note: In order to proceed with discharge activities, the Enbridge Construction Manager and Environment Staff assigned to the project, or their designees, must review the information and provide their authorization by signing and dating the form.**

Part 3: Discharge Monitoring: A copy of the permit, discharge plan, and parts one and two of the form must be on-site at all times during the discharge event. In addition to the items specified on the form, the following photographs are required:

- Receiving water before, during, and after the discharge (minimum 3 photos/day)
- Discharge structure/device before and during the discharge (minimum 3 photos/day)

As noted, upon completion of the discharge event, the Certified Operator or Environmental Inspector, Craft Inspector, Contractor Foreman, and Enbridge Construction Manager must sign and date the form. **The completed form, along with the supplemental photographs, and a copy of the chain of custody for any samples submitted for laboratory analysis must be submitted to the Enbridge Environment Project Manager/Lead within 12 hours of ending the discharge.** Any permit violations will be reported to the applicable agencies by the Enbridge Environment Project Manager/Lead within the timeframes specified in the discharge permit.



Part 1: Basic Discharge Information

Date: _____
 Project Name: _____ Spread: _____ Tract #: _____
 Test Section Identification: _____
 Pipe Diameter (inches): _____ Test Section Length (feet): _____
 Volume to be discharged (gallons): _____
 Permitted Discharge Rate (gpm): _____ Est. Duration of Discharge (hours): _____
 Receiving Waterbody Name/Nearest Surface Waterbody: _____
 Certified Operator Name and Number (if applicable): _____

Part 2: Pre-Discharge Planning Checklist

Note: All items must be complete prior to initiating discharge activities

- Notification to agency(ies) provided (if applicable - attach copy of notification documentation)
- Flow meter installed and functional in accordance with manufacturers recommendations
- Sample collection port/tap installed or other positive means of direct sampline of discharge water (only necessary if sampling is required)
- Review of discharge permit and site-specific plan complete (attach a copy of the permit and approved site specific plan)
- Discharge structure/BMPs installed according to approved plan
- Complete the table below, including quantity of samples required in accordance with the permit based on anticipated discharge duration. Add other parameters as specified in the permit:

Parameter	Analytical Method Number	Container type	Container Volume	Preservation	Maximum Holding Times	Permit Limit	Sample Type	Frequency of Analysis Specified in Permit	Number of Samples Required
pH	NA	Polyethylene / Glass	NA	None required	Analyze immediately		Field measurement		
Dissolved Oxygen	NA	Glass bottle and top	NA	None required	Analyze immediately		Field measurement		
TSS	106.2	Polyethylene	500 ml	Cool to 4° C	7 days				
Oil & Grease	1664	Amber Glass	1 liter	Cool to 4° C, HCL or H ₂ SO ₄ to pH <2	28 days				

- Indicate responsible party for emergency/upset/spill notifications in accordance with the permit: _____
- Indicate responsible party for to begin flow diversion when change in coloration observed: _____

All staff involved in hydrostatic test discharge activities must review the above information and print and sign their name below indicating their participation in a pre-job planning meeting and that they understand the discharge plan, permit, and procedures and are prepared to properly implement them. Attach additional sheets as necessary.

Name (print and sign):

Certified Operator or Environmental Inspector Signature: _____

Enbridge Environment and Construction Management staff reviewed the pre-planning information provided and approve the initiation of discharge activities.

Enbridge Environment Staff Signature and Date: _____

Enbridge Construction Manager Signature and Date: _____

Part 3: Discharge Monitoring - attach additional sheets as necessary
Note: Flow rate must be recorded hourly, sample frequency must be in accordance with the permit specifications

Date	Time	Recorded/Sampled By	Flow Rate (gpm)	pH	Dissolved Oxygen (mg/l)	TSS Sample Collected?	Oil & Grease Sample Collected?	Other (indicate)

Flow meter manufacturer and model: _____

Flow meter date of last calibration : _____

pH/Dissolved Oxygen instrument manufacturer and model: _____

pH/Dissolved Oxygen instrument date of last calibration: _____

Date and Time discharge start: _____ Date and Time discharge complete: _____

Equipment, Discharge, and Receiving Water Inspection Notes (minimum 3 entries per day):

Outfall Observations & Photo Documentation Notes (note presence or absence of any unusual characteristics such as unnatural turbidity, color, oil film, floating solids, foams, settleable solids, suspended solids, or deposits - minimum 3 entries per day) :

Certified Operator or Environmental Inspector Signature: _____

Enbridge Craft Inspector Signature: _____

Contractor Foreman Signature: _____

Enbridge Construction Manager Signature: _____

Appendix E

Emergency Response Contractors/Disposal and Treatment Facilities

The Contractor will dispose of all wastes according to applicable federal, state, and local requirements. A listing of potential Emergency Spill Response Contractors and waste disposal facilities is provided below. This list was developed from state-wide data bases. This list represents firms operating at the time the data base was produced. The Contractor is responsible for verifying if a contractor or facility is currently operating under appropriate permits or licenses. The Contractor is responsible for ensuring wastes are disposed of properly.

Spill Response Contractors

Company	City/State	Phone Number
North Dakota		
Clean Harbors Environmental	Williston, ND	(701) 774-2201 (800) 645-8265
Garner Environmental Services	Williston, ND	(701) 577-1200 (855) 774-1200
Absorbent & Safety Solutions	Watford City, ND	(701) 838-4558
Minnesota Limited	Berthold, ND	(701) 453-3700
Bobs Oilfield Service Inc	Belfield, ND	(701) 575-4666
Keitu Engineers & Consultants, Inc.	Mandan, ND	(701) 667-1800
Minnesota		
Bay West Environmental	St. Paul, MN	(800) 279-0456 (651) 291-0456
West Central Environmental Consultants Inc.	Morris, MN	(800) 422-8356 (888) 923-2778
Minnesota Limited	Bemidji, MN	(218) 755-9595
OSI Environmental	Bemidji, MN	(800) 585-8838
OSI Environmental	Eveleth, MN	(800) 777-8542
Bay West Environmental	Duluth, MN	(800) 279-0456 (218) 740-0110
Wisconsin - The Contractor should consult with the WDNR Northern Regional Spill Coordinator (John Sager: phone (715) 365-8959) for assistance when selecting a spill response contractor.		

Waste Disposal/Treatment Facilities

Facility	City/State	Telephone
North Dakota		
Gascoyne Materials Handling & Recycling LLC	Dickinson, ND	701.225.0061
Sawyer Disposal Services LLC*	Sawyer, ND	701.624.5622
Dishon Disposal Inc*	Williston, ND	701.572.3223
Prairie Disposal Inc*	Tioga, ND	800.490.2106
Minnesota		
Pope-Douglas Solid Waste	Alexandria, MN	(320) 762-2381
Northstar Reclamation	Fosston, MN	(800) 422-0817
Polk County Incinerator	Fosston, MN	(218) 435-6501
Wisconsin		
Lake Area Landfill (BFI)	Sarona, WI	(612) 457-2778
Timberline Trail (Waste Mgmt.)	Weyerhaeuser, WI	(800) 504-1067 ext. 7

Please note: Some facilities may have limitations on amounts, types of materials, etc.

*May accept crude oil-impacted soils and/or wastes from oil field exploration and production activities.

Appendix F

Spill Report Form



Spill Report Form

(The Contractor Spill Coordinator must complete this for any spill, regardless of size, and submit the form to the EPND Representative within 24 hours of the occurrence)

Date of Spill: _____ Date of Spill Discovery: _____

Time of Spill: _____ Time of Spill Discovery: _____

Name and Title of Discoverer: _____

Type of material spilled and manufacturer's name: _____

Legal Description of spill location to the quarter section: _____

Directions from nearest community: _____

Estimated volume of spill: _____

Weather conditions: _____

Topography and surface conditions of spill site: _____

Spill medium (pavement, sandy soil, water, etc.): _____

Proximity of spill to surface waters: _____

Did the spill reach a waterbody? _____ Yes _____ No

If so, was a sheen present? _____ Yes _____ No

Describe the causes and circumstances resulting in the spill: _____

Describe the extent of observed contamination, both horizontal and vertical (i.e., spill-stained soil in a 5-foot radius to a depth of 1 inch): _____

Describe immediate spill control and/or cleanup methods used and implementation schedule: _____

Current status of cleanup actions: _____

Name and Company for the following:

Construction Superintendent: _____

Spill Coordinator: _____

EPND Representative: _____

Person Who Reported the Spill: _____

Environmental Inspector: _____

Form completed by: _____ Date: _____

Appendix G

Spill Reporting-Agency Contacts

Sandpiper Pipeline Project Spill Reporting Contacts			
Agency	Reporting Criteria	When	Phone Number
Federal Contacts			
National Response Center	Release of a hazardous substance in an amount equal to or greater than its reportable quantity under CERCLA Any quantity of discharged oil that violates state water quality standards, causes a film or sheen on the water's surface, or leaves sludge or emulsion beneath the surface	Immediately	(800) 424-8802
Environmental Protection Agency (EPA) Region V (MN&WI)	Any quantity of discharged oil that violates state water quality standards, causes a film or sheen on the water's surface, or leaves sludge or emulsion beneath the surface	Immediately	1 (312) 353-2000
Environmental Protection Agency (EPA) Region VIII (ND)	Any quantity of discharged oil that violates state water quality standards, causes a film or sheen on the water's surface, or leaves sludge or emulsion beneath the surface	Immediately	1 (303) 312-6312
State Contacts			
North Dakota Industrial Commission, Oil and Gas Division	Must be a leak, spill or other release of fluid that is less than one barrel total volume and remains onsite of a facility.	Immediately	(701) 328-8020
North Dakota Department of Health	Any Amount	Immediately	(701) 328-5210 or 5166
North Dakota Department of Emergency Services (NDDDES)	As Needed	Immediately	NDDDES Duty Officer System (701) 328-9921 (24 hour, request the Duty Officer be paged) ND Regional Hazardous Materials Teams (800) 472-2121 (Teams requested through State Radio)

Sandpiper Pipeline Project Spill Reporting Contacts			
Agency	Reporting Criteria	When	Phone Number
Minnesota Duty Officer Program	Minnesota has a reporting threshold of greater than five-gallons for petroleum spills. Spills of any quantity of all other chemicals or materials should be reported. If in doubt, report.	Immediately	Duty Officer (651) 649-5451 1 (800) 422-0798
Wisconsin Department of Natural Resources	>one gallon of gasoline on a pervious surface	Immediately	24-hour Toll Free Hotline for Reporting Spills 1 (800) 943-0003
County Contacts – North Dakota			
Williams County Emergency Services County Law Enforcement Center	As Needed		Mike Hallesy (701) 577-7707
Mountrail County Emergency Management Resources	As Needed		Don Longmuir (701) 628-2909
Ward County Emergency Management	As Needed	8:00 a.m.–4:30 p.m. Monday- Friday	Amanda Schooling, Director (701) 857 6560
McHenry County Emergency Management	As Needed		Marvin Sola (815) 338-6400
Pierce County Emergency Management	As Needed	7:30 a.m.-4:30 p.m. Monday- Friday	Kelsey Siegler (253) 798-6595
Benson County Emergency Management	As Needed		Scott Todahl (701) 473-5320
Ramsey County Emergency Management	As Needed		Kristen Nelsen, Local Emergency Manager (701) 662-7001
Nelson County Emergency Management	As Needed		Sharon Young, Local Emergency Manager (701) 247-2472
Grand Forks County Emergency Services	As Needed		Jim Campbell (701) 780-8213
City of Grand Forks Emergency Services	As Needed		John Bernstrom (701) 746-4636
County Contacts – Minnesota			
Polk County Emergency Management	As Needed		Barb Erdman, Director (218) 281-0437
Red Lake County	As Needed		Mitch Bernstein

**Sandpiper Pipeline Project
Spill Reporting Contacts**

Agency	Reporting Criteria	When	Phone Number
Emergency Management			(218) 253-2996
Clearwater County Emergency Management	As Needed	8:00 a.m.–4:30 p.m. Monday-Friday	(218) 694-6183
Hubbard County Emergency Management	As Needed		Brian Halbasch (218) 732-2588
Cass County Emergency Management	As Needed		Kerry Swenson, Dispatcher (218) 547-7437
Crow Wing County Emergency Management	As Needed		John Bowen, Director (218) 829-4749
Aitkin County Emergency Management	As Needed		Dispatch (non-emergency) (218) 927-7400
Carlton County Emergency Management	As Needed		Brian Belich, Manager (218) 384-3236
County Contacts – Wisconsin			
Douglas County Emergency Management	As Needed	8:00 a.m.-4:30 p.m. Monday-Friday	Keith Kesler, Director (715) 395-1636